



Westermo OS Management Guide

Legal information

The contents of this document are provided "as is". Except as required by applicable law, no warranties of any kind, either express or implied, including, but not limited to, the implied warranties of merchantability and fitness for a particular purpose, are made in relation to the accuracy and reliability or contents of this document. Westermo reserves the right to revise this document or withdraw it at any time without prior notice.

Under no circumstances shall Westermo be responsible for any loss of data or income or any special, incidental, and consequential or indirect damages howsoever caused. More information about Westermo can be found at the following Internet address: <http://www.westermo.com>

Contents

Legal information	2
Table of Contents	3
I Introduction to WeOS and its Management Methods	10
1 Introduction	11
1.1 Westermo and its WeOS products	11
1.2 Getting Started	11
1.3 Introduction to WeOS	12
1.4 How to read this document	12
1.5 Westermo products running WeOS	14
2 Quick Start	16
2.1 Starting the Switch for the First Time	16
2.2 Modifying the IP Setting	17
3 Overview of Management Methods	29
3.1 When to use the WeConfig tool	30
3.2 When to use the Web	30
3.3 When to use the CLI	31
4 Management via Web Interface	33
4.1 Document Conventions	34
4.2 Logging in	35
4.3 Navigation	37
4.4 System Overview	40
5 Management via CLI	47

5.1	Overview of the WeOS CLI hierarchy	47
5.2	Accessing the CLI	49
5.3	Using the CLI	53
5.4	General CLI commands	59
6	WeOS SNMP Support	63
6.1	Introduction and feature overview	63
6.2	Managing SNMP via the web interface	76
6.3	Manage SNMP Settings via the CLI	80
II	Common Switch Services	85
7	General Switch Maintenance	86
7.1	Overview	86
7.2	Maintenance via the Web Interface	122
7.3	Maintenance via the CLI	138
8	General System Settings	169
8.1	Overview of General System Features	169
8.2	Managing System Settings via Web	174
8.3	Managing System Settings via CLI	182
9	Authentication, Authorisation and Accounting	203
9.1	Overview over AAA	204
9.2	Managing AAA via the web	213
9.3	Managing AAA via the CLI	233
9.4	Feature Parameters	253
10	Ethernet Port Management	254
10.1	Overview of Ethernet Port Management	254
10.2	Managing port settings via the web interface	270
10.3	Managing port settings via the CLI	274
11	Ethernet Statistics	287
11.1	Ethernet Statistics Overview	287
11.2	Statistics via the web interface	294
11.3	Statistics via the CLI	299
12	SHDSL Port Management	302
12.1	Overview of SHDSL Port Management	302
12.2	Managing SHDSL ports via the web interface	308

12.3 Managing SHDSL ports via the CLI	316
13 ADSL/VDSL Port Management	322
13.1 Overview of ADSL/VDSL Port Management	322
13.2 Managing ADSL/VDSL ports via the web interface	336
13.3 Managing ADSL/VDSL ports via the CLI	348
14 Power Over Ethernet (PoE)	353
14.1 Overview of Power over Ethernet (PoE)	353
14.2 Managing PoE via the web interface	358
14.3 Managing PoE via the CLI interface	363
15 Virtual LAN	366
15.1 VLAN Properties and Management Features	366
15.2 Port-based network access control	383
15.3 Managing VLAN settings via the web interface	388
15.4 Managing VLAN settings via the CLI	398
16 FRNT	410
16.1 Overview of the FRNT protocol and its features	410
16.2 FRNT, RSTP and MRP coexistence	418
16.3 Managing FRNT settings via the web interface	420
16.4 Managing FRNTv0 and v2 settings via the CLI	426
16.5 Feature Parameters	433
17 Ring Coupling and Dual Homing	434
17.1 Overview	435
17.2 Managing via the Web	450
17.3 Managing via CLI	454
17.4 Feature Parameters	464
18 Spanning Tree Protocol - RSTP and STP	465
18.1 Overview of RSTP/STP features	465
18.2 Managing RSTP via the web interface	471
18.3 Managing RSTP via the CLI	475
19 Media Redundancy Protocol	480
19.1 Overview of the MRP protocol and its features	480
19.2 Managing MRP settings via the web interface	486
19.3 Managing MRP settings via the CLI	489
20 Link Aggregation	495

20.1 Link Aggregation Support in WeOS	495
20.2 Managing Link Aggregation via the Web	506
20.3 Managing Link Aggregation via CLI	510
21 Multicast in Switched Networks	515
21.1 Overview	515
21.2 Reserved Multicast Groups	529
21.3 Managing IGMP in the Web Interface	531
21.4 Managing IGMP in the CLI	535
22 General Network Settings	541
22.1 Overview	541
22.2 Network interfaces	542
22.3 General IP settings	560
22.4 Managing network interfaces via the web	565
22.5 Managing general IP settings via the web	572
22.6 Managing network interfaces via the CLI	579
22.7 Managing general IP settings via the CLI	591
22.8 Feature Parameters	607
23 DHCP Server	608
23.1 Overview of DHCP Server Support in WeOS	609
23.2 Configuring DHCP Server Settings via the Web	625
23.3 Configuring DHCP Server Settings via the CLI	633
23.4 Feature Parameters	649
24 DHCP Relay Agent	650
24.1 Overview of DHCP Relay Agent Support	651
24.2 Configuring DHCP Relay Agent via the Web	662
24.3 Configuring DHCP Relay Agent via the CLI	665
24.4 Feature Parameters	671
25 Alarm handling, LEDs and Digital I/O	672
25.1 Alarm handling features	672
25.2 Managing Alarms via the Web	684
25.3 Managing Alarms via the CLI	690
25.4 Digital I/O	720
25.5 LEDs	722
26 Port Monitoring	725
26.1 Overview of Port Monitoring support	725

26.2 Port Monitoring in the Web	727
26.3 Port Monitoring via the CLI	728
27 Logging	730
27.1 Overview of Logging support	731
27.2 Managing Logging via the Web	742
27.3 Managing Logging via the CLI	748
III Router/Gateway Services	755
28 IP Routing in WeOS	756
28.1 Summary of WeOS Routing and Router Features	756
28.2 Static unicast routes via Web	765
28.3 Enabling Routing, Managing Static Routing, etc., via CLI	768
29 Dynamic Routing with OSPF	770
29.1 Overview of OSPF features	770
29.2 OSPF Web	785
29.3 Managing OSPF via the CLI	789
30 Dynamic Routing with RIP	801
30.1 Overview of RIP Features	801
30.2 RIP Web	807
30.3 Managing RIP via the CLI	810
31 IP Multicast Routing	818
31.1 Summary of WeOS Multicast Routing Features	818
31.2 Managing Multicast Routing via Web Interface	822
31.3 Managing Multicast Routing via CLI	827
32 Virtual Router Redundancy (VRRP)	831
32.1 Introduction to WeOS VRRP support	832
32.2 Managing VRRP via the web interface	839
32.3 Managing VRRP via the CLI	844
33 Firewall Management	852
33.1 Overview	853
33.2 Firewall Management via the Web Interface	883
33.3 Firewall Management via the CLI	910

IV Virtual Private Networks and Tunnels	926
34 Overview of WeOS VPN and Tunnel support	927
34.1 WeOS support for VPNs	927
34.2 Tunneling using PPP	928
34.3 Tunneling using GRE	928
35 PPP Connections	929
35.1 Overview of PPP Properties and Features	930
35.2 Managing PPP settings via the web interface	939
35.3 Managing PPP settings via the CLI	945
36 GRE tunnels	955
36.1 Overview of GRE tunnel Properties and Management Features	955
36.2 Managing GRE settings via the web interface	959
36.3 Managing GRE settings via the CLI	961
37 IPsec VPNs	964
37.1 Overview of IPsec VPN Management Features	965
37.2 Managing VPN settings via the web interface	986
37.3 Managing VPN settings via the CLI	997
37.4 Feature Parameters	1013
38 SSL VPN	1014
38.1 Overview of SSL VPN Management Features	1014
38.2 Managing SSL VPN settings via the web interface	1047
38.3 Managing SSL VPN settings via the CLI	1053
38.4 Feature Parameters	1067
39 WeConnect	1068
39.1 Installing WeConnect via the Web	1070
39.2 Installing WeConnect via the CLI	1072
39.3 Troubleshooting	1074
V Serial Port Management and Applications	1077
40 Serial Port Management	1078
40.1 Overview of Serial Port Management	1079
40.2 Managing serial ports via the web interface	1082
40.3 Managing serial ports via the CLI interface	1085

41 Serial Over IP	1090
41.1 Overview of Serial Over IP	1090
41.2 Managing Serial Over IP via the web interface	1103
41.3 Managing Serial Over IP via the CLI interface	1110
42 Modbus Gateway	1123
42.1 Managing Modbus Gateway via the web interface	1125
42.2 Managing Modbus Gateway via the CLI interface	1129
43 MicroLok II Gateway	1138
43.1 Overview of MicroLok Gateway Properties and Management Features	1138
43.2 Managing MicroLok Gateway via the web interface	1142
43.3 Managing MicroLok Gateway via the CLI interface	1146
VI Train Specific Protocols	1153
44 TTDP	1154
44.1 Overview of TTDP Management Features	1154
44.2 Managing TTDP settings via the CLI	1174
VII Appendixes	1181
Acronyms and abbreviations	1182
References	1186
Index	1191

Part I

Introduction to WeOS and its Management Methods

Chapter 1

Introduction

1.1 Westermo and its WeOS products

Westermo provides an extensive set of network products for robust industrial data communications, *managed* as well as *unmanaged* products. Westermo's products are found in diverse set of harsh environment applications, and where robustness and reliability are vital properties.

This guide describes the extensive functionality of managed Westermo products running the *Westermo OS* (WeOS).

1.2 Getting Started

Please see www.westermo.com for the latest updated version of this document – the *WeOS Management Guide*. There you can also find product User Guides, and other support information for your product.

The dedicated *User Guide* of your product includes information on how to get started with WeOS on your specific product. That is a good place to start if you wish to do the least possible configuration of your switch (i.e., assign appropriate IP settings) before putting it into your network infrastructure.

If the User Guide of your specific product lacks a section on how to get started with WeOS, please visit the [chapter 2 \(Quick Start\)](#) of this document.

1.3 Introduction to WeOS

Westermo OS (WeOS) is a network operating system delivering an extensive set of functionality including layer-2 (basic switching, VLAN, IGMP snooping, etc.), layer-3 (routing, firewall, NAT, etc.), and higher-level services (DHCP, DNS, etc.). Furthermore, WeOS provides easy management via a Web interface, via the associated WeConfig tool, and via a USB stick. To satisfy even more advanced customer needs, WeOS provides flexible management via a command line interface (CLI), as well as via SNMP.

WeOS provides two levels of functionality, *WeOS Standard* and *WeOS Extended*. Products running WeOS Standard are outstanding layer-2 switches suitable to build reliable LAN infrastructures. Products running WeOS Extended extends the WeOS functionality by adding routing capabilities and a rich set of related higher level services (NAT, firewall, VPN, etc.).

1.4 How to read this document

This guide is structured in the following parts:

- **Part I:** This part gives general information on WeOS, and introduces the main methods to *manage* a WeOS unit (WeConfig, Web, CLI and SNMP)¹.

The information in **Part I** applies both to products running WeOS Standard and WeOS Extended.

- **Chapter 1** is this chapter.
- **Chapter 2** describes how to *get started* with your WeOS product.
- **Chapters 3** gives an overview of the different ways to manage a WeOS unit. If you need recommendations of which method to use, please read **chapter 3**.
- **Chapters 4-5** present the WeOS Web and CLI support. Detailed information for Web and CLI Management is provided in the later parts of the document.
- **Chapters 6** is the main source of information for WeOS SNMP support.
- **Part II:** Each of the chapters in this part covers services and features in common software levels *Standard* and *Extended*.

¹For information on how to configure a WeOS unit using a USB memory stick, see **Chapter 7**.

- [Chapter 7](#) handles general maintenance task (firmware upgrade, configuration file handling, factory reset, etc.) and tools such as *ping*, *traceroute*, which be useful when troubleshooting your network.
- [Chapters 8-9](#) handle various general System settings and AAA services.
- [Chapters 10-14](#) cover management of Ethernet, SHDSL and xDSL (ADSL/VDSL) ports.
- [Chapters 15-21](#) concern various layer-2 services in WeOS (VLANs, layer-2 redundancy (FRNT, RSTP, Link Aggregation), and IGMP Snooping).
- [Chapter 22](#) covers network interface configuration including IP address, netmask, etc., as well system wide network settings such as default gateway and DNS.
- [Chapters 23-27](#) handle DHCP services (DHCP Server and Relay), and status maintenance (Alarm, Digital I/O, Front Panel LEDs, port monitoring, and logging).
- [Part III](#) covers WeOS router/gateway services. These features are only applicable for WeOS Extended products.
 - [Chapters 28-32](#) describe static and dynamic routing, and VRRP support in WeOS.
 - [Chapter 33](#) concerns NAT and Firewall support.
- [Part IV](#) covers WeOS VPN and tunneling services. These features are only provided for WeOS Extended products.
 - [Chapter 34](#) gives an overview to VPN and tunneling services.
 - [Chapter 35](#) covers PPP support (PPP over serial port and PPPoE).
 - [Chapter 36](#) describes GRE tunneling support.
 - [Chapters 37-38](#) present VPN support using IPsec and SSL (OpenVPN).
- [Part V](#) contains information on serial port configuration ([chapter 40](#)) and applications. These features apply to WeOS products with serial ports, both for WeOS Standard and WeOS Extended.
 - [Chapter 41](#) describes Serial Over IP and Modem Replacement functionality
 - [Chapters 42-43](#) cover Modbus Gateway and Microlok Gateway support.
- [Part VI](#) contains information on train related protocols and train networks.

- [Chapter 44](#) describes WeOS support for the Train Topology Discovery Protocol (TTDP)[[17](#)]. TTDP support is limited to RFR-212-FB products[[60](#)].

1.5 Westermo products running WeOS

Below you find the list of Westermo products running WeOS, as well as references to their respective *User Guide*:

- Falcon: User Guide [[52](#)] (FDV-206-1D1S). ("Basis" platform)
- Lynx: User Guides [[57](#)] (Lynx-L110/210) and [[53](#)] (Lynx-L106/206-F2G). ("Basis" platform)
- Lynx-DSS: User Guides [[54](#)] (L108/208-F2G-S2), [[55](#)] (L105/205-S1), and [[56](#)] (L106/206-S2). ("Basis" platform)
- RedFox Industrial (RFI): User Guide [[58](#)] (Various RFI models). ("Corazon" platform)
- RedFox Industrial Rack (RFIR): User Guide [[59](#)] (Various RFIR models). ("Corazon" platform)
- RedFox Rail (RFR): User Guide [[60](#)] (RFR-212-FB). ("Corazon" platform)
- Wolverine: User Guides [[47](#)] (DDW-142/242²), [[48](#)] (DDW-142/242-485)³, [[49](#)] (DDW-142/242-BP), [[50](#)] (DDW-225) and [[51](#)] (DDW-226). ("Basis" platform)
- Viper:
 - Viper-12A and Viper-20A ("Coronet" platform): User Guides [[63](#)] (Viper-112A/212A), [[64](#)] (Viper-112A/212A-P8), [[65](#)] (Viper-120A/220A), and [[66](#)] (Viper-120A/220A-P8). See the user guides for details on available variants, including number of Gigabit ports.
 - Viper-12 ("Basis" platform): [[61](#)] (Viper-112/212 and Viper-112/212-T3G) and [[62](#)] (Viper-112/212-P8 and Viper-112/212-T3G-P8).



Note

Basis, Corazon and Coronet denote HW platforms used by different products. Products utilising the same HW platform use the same kind of CPU, and have the same amount of RAM and flash memory.

²DDW-142 and DDW-242 are also referred to as DDW-x42 in this guide.

³DDW-142-485 and DDW-242-485 are also referred to as DDW-x42-485 in this guide.

1.5.1 Product hardware details affecting WeOS functionality

The WeOS functionality described in the Management Guide generally applies to all Westermo products running WeOS of the appropriate software level (Standard or Extended). However, where functionality assumes the presence of certain hardware (such as a USB port), those functions are limited to products including that hardware. The table below provides a summary of hardware differences affecting the availability of certain WeOS functions. For a more definite description of hardware specifications you are referred to the dedicated *User Guide* of each product (see [section 1.5](#)).

	Ethernet Ports	SHDSL Ports	xDSL Port	Serial Port(s)	Console port	Digital In/Out	USB Port	Bypass Relay	PoE Ports
Falcon FDV-206-1D1S	X		X	X	X	X	X		
Lynx L106/206-F2G L110/210	X X				X X	X X	X		
Lynx-DSS All Lynx-DSS models	X			X	X	X	X		
RedFox Industrial & RedFox Industrial Rack All RFI and RFIR models	X				X	X	X		
RedFox Rail RFR-212-FB	X						X	X ¹	
Viper All "non-PoE" models All "PoE" models	X X				X X		X X		X
Wolverine DDW-x42 DDW-x42-485 DDW-x42-BP DDW-225 DDW-226	X X X X X	X ² X ² X ² X X		X X X X X	X X X X X	X X X X X	X X X X X		X ¹

¹Bypass Relay is available on DDW-x42-BP and RFR-212-FB. See the related User Guides, listed in [section 1.5](#), for more information on bypass relay functionality.

²The DDW-x42 SHDSL ports have support for PAF (SHDSL link bonding).

Chapter 2

Quick Start

This section provides a guide to quickly get started with your switch. Only simple configuration procedures will be covered¹. The steps covered concern:

- Get familiar with the factory default setting
- Configuring an appropriate IP address

2.1 Starting the Switch for the First Time

When booting the switch for the first time the switch will use the factory default setting.

The factory default setting makes the switch operate as a manageable layer-2 switch, where all Ethernet ports belong to the same virtual LAN (VLAN)².

- **Manageable:** The switch is manageable via any of the Ethernet ports. To manage the switch via an Ethernet port you need to know the IP address of the switch (see [table 2.1](#)). For switches equipped with a console port, the switch can as well be managed via that port without knowing the IP address of the switch.
- **Single VLAN:** By default all ports on the switch will belong to the same VLAN. Thus, devices connected to different ports of the switch should be able to

¹For more advanced settings, we refer to the remaining chapters of this guide as well as the online help provided via the Web configuration tool and the Command Line Interface (CLI).

²On Falcon series of switches, all Ethernet ports belong to the default VLAN (VLAN 1), while the xDSL port belongs to a separate VLAN (VLAN 1006). That is, by factory default Falcon operates as a router. See [chapter 13](#) for more details.

communicate with each other right away. For more advanced setups, the ports of the switch can be grouped into different VLANs. In the factory default setting all ports belong to VLAN 1.

The default IP setting for the switch is as shown in [table 2.1](#).

	Address	Netmask	Gateway
Primary IP address	Dynamic (DHCP)	(Dynamic)	(Dynamic)
Secondary IP address	192.168.2.200	255.255.255.0	Disabled

Table 2.1: Factory Default IP settings.

Thus, when you power up your WeOS unit with the factory configuration, you can connect to it via two addresses:

- The *static* IP address *192.168.2.200*: This address is simplest to use if you are setting up a single unit.
- A *dynamic* address assigned by a DHCP server³ (if present): This address may be simplest to use if you want to connect and configure multiple new WeOS units simultaneously.



Note

Before you put your switch into your production network you should change its IP setting according to your network topology. How you change your IP setting is described in the next section.

2.2 Modifying the IP Setting

The switch can be configured with a static IP setting, or it can get its IP address dynamically via DHCP. The latter case is useful if you are running a DHCP server on the same LAN as the switch will be located.

WeOS provides several management tools, which will be presented further in later chapters of this guide. In this chapter we limit the scope to describe how these tools can be used to update the IP settings of the switch.

- *WeConfig*: is Westermo's Network configuration management tool (NCM) made for commissioning and maintenance of components in a network. It

³In addition, the unit will autoconfigure itself with a *link-local* address in the *169.254.x.x* range, where 'x' is in interval 0-255. See [section 22.2.6](#) for more information.

replaces the former Westermo tool known as *IPConfig*. For further information on WeConfig's features and how to use the tool, see the WeConfig User Guide[68].

- *Web*: Configuration of IP settings via the Web interface is described in [section 2.2.1](#).
- *CLI*: Configuration of IP settings via the Command Line Interface (CLI) is described in [section 2.2.2](#).



Hint

If you are not sure what IP address your switch has, use the *WeConfig* tool, or the *CLI via console* method ([section 2.2.2.1](#)). If neither of these methods work, please visit [section 7.1.3](#) for information on how to conduct a factory reset.

2.2.1 Using the Web Interface to Update the Switch IP Settings

To configure the IP settings via web your switch is required to be located on the same IP subnet as your PC.

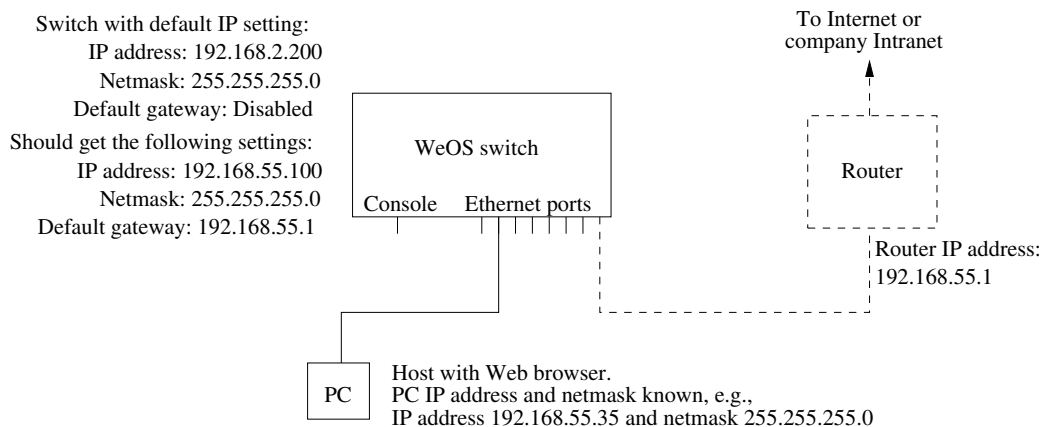

In this *example* the switch shall be assigned the IP address 192.168.55.100, netmask 255.255.255.0 and default gateway 192.168.55.1. To achieve this you must (temporarily) change the IP address of the PC in order to be able to communicate with the switch.

The steps to configure the IP settings via the web interface are as follows:

1. *Connect your PC to the switch:* Connect your PC to the switch as shown in the figure above.
2. *Modifying IP Settings on PC:* The IP settings on the PC must be updated to match the default settings on the switch, i.e., the PC should be assigned an IP address on the 192.168.2.0/24 network, e.g.,
 - PC IP address: 192.168.2.1
 - PC Netmask: 255.255.255.0
3. *Access switch via web browser:* Open your web browser and enter URL **http://192.168.2.200** in the browser's address field. You will be asked to enter a *username* and a *password*. Use the factory default account settings shown below:
 - Login username: **admin**
 - Password: **westermo**

4. *Open the Network configuration page:* Click on the **Configuration** top-menu and then on the **Network** sub-menu and then the **Global settings** menu.

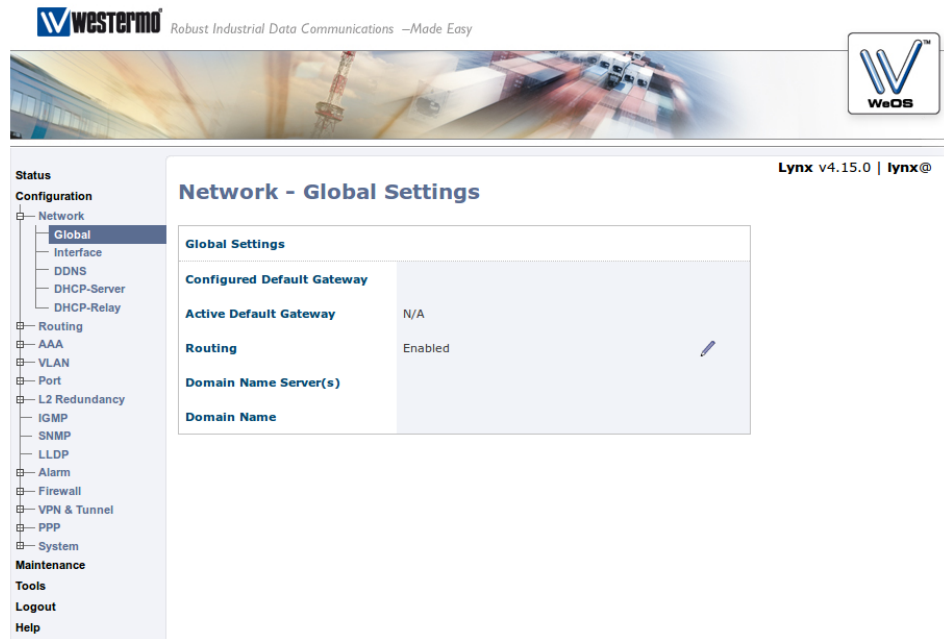

5. *Configure Default Gateway:* Now click the edit icon (✎) in the **Global Settings** frame. The following page should appear.

Network - Global Settings

Default Gateway	<input type="text" value="192.168.55.11"/>
Routing	<input checked="" type="checkbox"/>
Name server 1	<input type="text"/>
Name server 2	<input type="text"/>

Fill in the appropriate address in the **Default Gateway** field. In this example, the default gateway is 192.168.55.1. Click the **Apply** button. Your switch is configured with a new default gateway.

6. *Open Interface Configuration Page:* Click on the **Configuration** top-menu and then on the **Network** sub-menu and then the **Interface** sub menu. In

the **Interface** page, click the *edit* icon (✎) on the row for the interface named **vlan1**. The *Interface Configuration Page* will appear:



7. *Configure Interface IP Settings:* Enter the appropriate IP settings for your switch. In this example we would:

- Set **IP Address Method** to **static** (radio button).
- Set **Primary Address** to **192.168.55.100** with **255.255.255.0** in the **Netmask** field.
- Remove Secondary Address (**192.168.2.200**) using the *trash* icon (🗑️).

Click the **Apply** button and your switch is configured with a new IP address.

8. *Reconfigure PC's IP Settings:* As the IP address is changed on the switch, you cannot reach it from your PC any longer. To access the switch from the PC, the PC's IP settings must be changed again. In this case, we assume it is changed back to its original settings:

- PC IP address: 192.168.55.35
- PC Netmask: 255.255.255.0
- PC Default Gateway: 192.168.55.1

Further management of the switch can be performed via any of the available management tools - WeConfig, Web, SSH/Telnet/CLI or SNMP.

2.2.2 Using the CLI to Update the Switch IP Settings

The CLI can be accessed in three ways: via the console port (given that the switch is equipped with a console port) or via the Ethernet ports using the Secure Shell (SSH) or the Telnet protocol. [Section 2.2.2.1](#) explains how to access the CLI via the console port, and how to update the IP settings. [Section 2.2.2.2](#) explains how to access the CLI via SSH.

Access with Telnet is also possible, but this is **not enabled** by default on the switch, and to use it you will first have to access it with one of the other methods and enable this protocol for management. See [Section 8.3.34 \(CLI\)](#) for information on how to *enable the Telnet service* on the unit, and then [Section 22.4 \(Web\)](#) or [Section 22.6.6](#) for information on how to enable Telnet configuration via interface **"vlan1"**.

2.2.2.1 Accessing the CLI via the console port

For WeOS switches equipped with a console port, this port can be used to change IP address of the switch.

1. *Connect your PC to the switch:* Connect your PC to the switch as shown in the figure below.

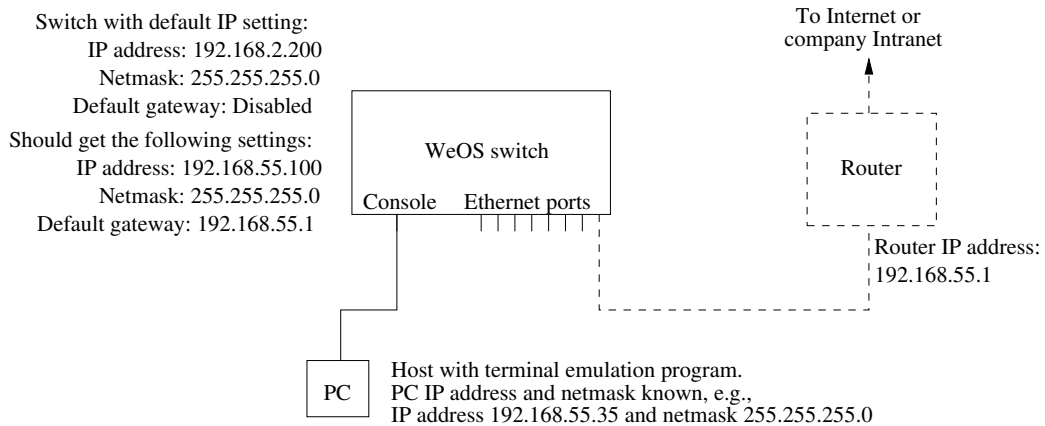

i Important notice for WeOS Switches equipped with a console port

See the User Guide of your specific product ([section 1.5](#)) for information on what Diagnostic Cable to use when connecting to the console port of your specific product.

 **Example**

```
example:/#> show iface
Press Ctrl-C or Q(uit) to quit viewer, Space for next page, <CR> for next line.
```

Interface Name	Oper	Address/Length	MTU	MAC/PtP Address
lo	UP	127.0.0.1/8	16436	N/A
vlan1	UP	192.168.2.200/24 169.254.145.230/16	1500	00:07:7c:10:de:e1

```
example:/#>
```

6. *Changing IP address and netmask:* To change the switch IP addressing mode ("static" instead of "DHCP"), set a static address and netmask, and to skip secondary addresses, use CLI commands "**configure**", "**iface vlan1**", "**inet static**", "**address <IPV4ADDRESS/LEN>**", "**no address secondary**" and "**end**" as shown below. This example is based on the setup in step 1, and configures the switch with an address (192.168.55.100/24) on the same IP subnet as the PC.

 **Example**

```
example:/#> configure
example:/config/#> iface vlan1
example:/config/iface-vlan1/#> inet static
example:/config/iface-vlan1/#> address 192.168.55.100/24
example:/config/iface-vlan1/#> no address secondary
Remove all secondary IP addresses, are you sure (y/N)? y
Removing all secondary IPs!
example:/config/iface-vlan1/#> end
example:/config/#> end
Stopping DHCP Clients ..... [ OK ]
Configuration activated. Remember "copy run start" to save to flash (NVRAM).
example:/#> show iface
Press Ctrl-C or Q(uit) to quit viewer, Space for next page, <CR> for next line.
```

Interface Name	Oper	Address/Length	MTU	MAC/PtP Address
lo	UP	127.0.0.1/8	16436	N/A
vlan1	UP	192.168.55.100/24	1500	00:07:7c:10:de:e1

```
example:/#>
```

7. *Set default gateway IP address:* The figure below shows the same network setup, but with a router attached to the IP subnet.

With this setup you would like to configure a *default gateway* IP address to allow management of the switch from outside the local network. This can be achieved using CLI commands "**configure**", "**ip**", "**route default 192.168.55.1 <IPADDRESS>**", and "**end**" as shown below.

Example

```
example:/#> configure
example:/config/#> ip
example:/config/ip/#> route default 192.168.55.1
example:/config/ip/#> end
example:/config/#> end
Configuration activated. Remember "copy run start" to save to flash (NVRAM).
example:/#>
```

8. *Save configuration*: Although the configuration changes has been activated, the running configuration must be stored to the startup configuration. Otherwise the changes will be lost if the switch is rebooted.

Example

```
example:/#> copy running-config startup-config
example:/#>
```

9. You are now done setting the IP address, subnet mask and default gateway of your switch. Logout from the CLI using the "**logout**" command.

Further management of the switch can be performed via any of the available management tools - WeConfig, Web, SSH/Telnet/CLI or SNMP.

2.2.2.2 Accessing the CLI via SSH

Configuring the IP settings via SSH/CLI is very similar to configuring them via the console port. The major differences are:

- The IP address of the PC must (temporarily) be changed in order to be able to communicate with the switch, i.e., the PC should have an address on network 192.168.2.0/24, e.g., 192.168.2.1/24.
- After the IP settings have been changed on the switch, the PC is likely to loose contact with the switch. The PC must therefore change its IP address again, and login to the switch again in order to copy the running configuration to the startup configuration.

The steps to configure the IP settings via SSH/CLI are as follows:

1. *Connect your PC to the switch:* Connect your PC to the switch as shown in the figure below. In this example we assume the switch will get IP address 192.168.55.100, netmask 255.255.255.0 and default gateway 192.168.55.1.

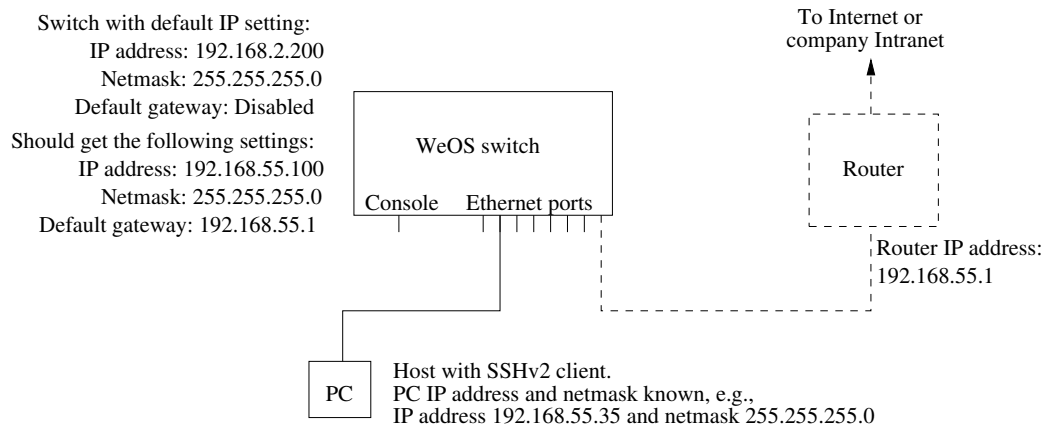

2. *Modifying IP Settings on PC:* The IP settings on the PC must be updated to match the default settings on the switch, i.e., the PC should be assigned an IP address on the 192.168.2.0/24 network, e.g.,
 - PC IP address: 192.168.2.1
 - PC Netmask: 255.255.255.0
 - PC Default Gateway: Not needed
3. *Connecting and Logging in:* When connecting via SSH you will be asked to enter a *username* and thereafter a *password*. For a switch using the factory default settings, use the following login username and password:
 - Login username: **admin**
 - Password: **westermo**

The procedure to connect may vary slightly depending on what SSH client you are using. The example below show the connection procedure using Unix OpenSSH⁴. (On Windows one can use Putty⁵.)

⁴OpenSSH, <http://www.openssh.com>

⁵Putty, <http://www.chiark.greenend.org.uk/~sgtatham/putty/>

Example

```

user@pc:~$ ssh admin@192.168.2.200
The authenticity of host '192.168.2.200 (192.168.2.200)' can't be established.
RSA key fingerprint is 6d:0c:f3:d3:28:d6:d8:43:bc:69:f8:d0:d6:a2:27:87.
Are you sure you want to continue connecting (yes/no)? yes
Warning: Permanently added '192.168.2.200' (RSA) to the list of known hosts.
admin@192.168.2.200's password:
-----
| | | | -_--_-- --| | -| -_--| -| | | | |
|-----|-----|-----|-----|-----|-----|
www.westermo.com

\\ Westermo WeOS v4.15.0 4.15.0 -- Jun 16 19:10 CEST 2014
Type: 'help' for help with commands, 'exit' to logout or leave a context.

example:/#>

```

4. *Changing IP settings:* The switch IP settings are changed with the same commands as described when accessing the CLI via the console port ([section 2.2.2.1](#)). In this example we assign IP address, netmask and default gateway.

Example

```

example:/#> configure
example:/config/#> iface vlan1
example:/config/iface-vlan1/#> inet static
example:/config/iface-vlan1/#> address 192.168.55.100/24
example:/config/iface-vlan1/#> no address secondary
Remove all secondary IP addresses, are you sure (y/N)? y
Removing all secondary IPs!
example:/config/iface-vlan1/#> end
example:/config/#> ip
example:/config/ip/#> route default 192.168.55.1
example:/config/ip/#> end
example:/config/#> end

```

The configuration is now changed, but not yet saved to the startup configuration. However, as the IP address is changed, the SSH connection will be broken.

5. *Logging in again to save configuration:* To login again, the PC's IP settings must be changed again. In this case, we assume it is changed back to its original settings:
 - PC IP address: 192.168.55.35
 - PC Netmask: 255.255.255.0

- PC Default Gateway: 192.168.55.1

We can then login again to copy the running configuration to startup configuration.

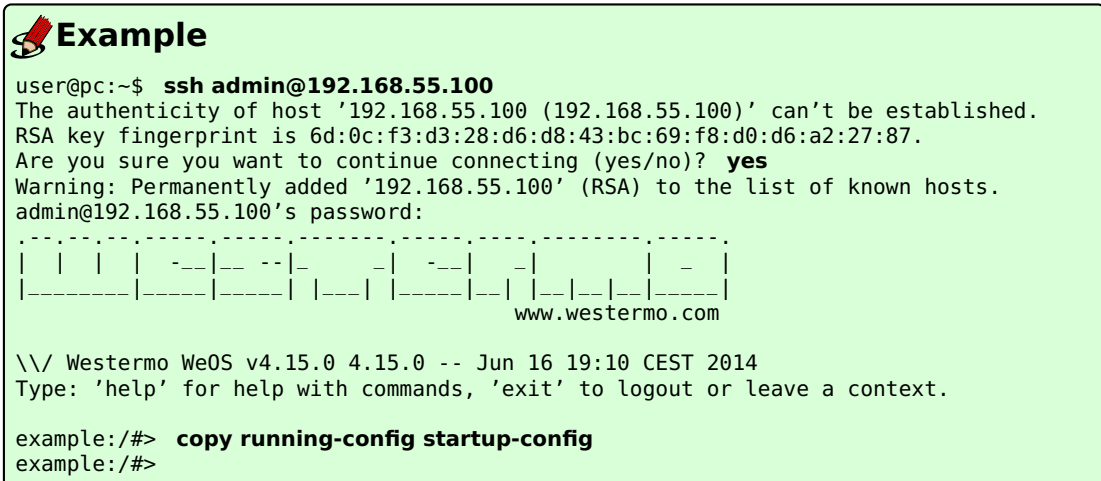

```
Example
user@pc:~$ ssh admin@192.168.55.100
The authenticity of host '192.168.55.100 (192.168.55.100)' can't be established.
RSA key fingerprint is 6d:0c:f3:d3:28:d6:d8:43:bc:69:f8:d0:d6:a2:27:87.
Are you sure you want to continue connecting (yes/no)? yes
Warning: Permanently added '192.168.55.100' (RSA) to the list of known hosts.
admin@192.168.55.100's password:
.....
| | | | _ _ | _ _ | _ _ | _ _ | |
|-----|-----|-----|-----|-----|
                                     www.westermo.com

\\ Westermo WeOS v4.15.0 4.15.0 -- Jun 16 19:10 CEST 2014
Type: 'help' for help with commands, 'exit' to logout or leave a context.

example:/#> copy running-config startup-config
example:/#>
```

You are now done setting the IP address, subnet mask and default gateway of your switch. Logout from the CLI using the **“logout”** command.

Further management of the switch can be performed via any of the available management tools - WeConfig, Web, SSH/CLI or SNMP.

Chapter 3

Overview of Management Methods

WeOS is managed and monitored using the following tools and interfaces:

- **WeConfig:** is Westermo's Network configuration management tool (NCM) made for commissioning and maintenance of components in a network. It replaces the former Westermo tool known as *IPConfig*. For further information on WeConfig's features and how to use the tool, see the WeConfig User Guide[68].
- **Web:** The WeOS Web interface provides management of essential features. The Web interface should satisfy the needs of all common use cases.
- **CLI:** The WeOS Command Line Interface is an industry standard CLI, and provides the most complete management support. The CLI is intended for advanced users requiring fine grain control of the system.

In addition, WeOS provides device management via SNMP (v1/v2c/v3). A set of standard MIBs and the WeOS private MIB are supported, as described in [chapter 6](#).

Task	WeConfig	Web	CLI	SNMP
Discover WeOS Devices	X	(X)	(X)	
Set Device IP Address	X	X	X	X
Upgrade firmware	X	X	X	
Common management tasks		X	X	X
All management tasks			X	
Secure management		X	X	X

In the following sections the properties of the WeConfig tool, the Web Interface, and the CLI are presented further. These sections give information about what management tool to use for a specific need. For more information on SNMP we refer to [chapter 6](#).

3.1 When to use the WeConfig tool

The Westermo configuration management tool, WeConfig, is used for basic configuration and maintenance of WeOS products. It is an ideal tool to *upgrade firmware* and *manage configuration files* (backup and restore) of a *large set of WeOS devices*. With WeConfig you can scan, discover and draw maps of the WeOS devices in your network, and you can also conduct some basic configuration of WeOS units, such as setting the IP address and the default gateway.

For further information on WeConfig's features and how to use the tool, see the WeConfig User Guide[68].

3.2 When to use the Web Interface

The Web interface would be the management interface of choice for most users. The main advantages of the Web Interface are:

- *Easy to use:* The Web management interface provides an *easy to use* method to manage the switch.
- *All common features:* The web interface includes support for all essential management features, and should therefore meet the needs of most users.
- *Secure management:* The web interface can be accessed via regular HTTP and secure HTTP (HTTPS). Secure management is also possible via the CLI (SSHv2) and and SNMP (SNMPv3).

- *Discover other Westermo Switches:* The Web contains a discovery service (IPconfig) similar to what WeConfig provides. (Note, you must still be able to login to one switch in order to make use of this service.)

To use the Web interface, you must know the IP address of your switch. To find out the switch IP address you may need to use the WeConfig tool¹, but once you know it you can do the rest of the management via the Web interface.

The Web interface is introduced in [chapter 4](#).

3.3 When to use the Command Line Interface (CLI)

The WeOS CLI aims to serve advanced users. Furthermore, the CLI is the only management tool which cannot be disabled.

Below we list the situations where the CLI is the most suitable management tool.

- *Complete set of management features:* The CLI includes all the management features available on the switch. If you cannot accomplish your task with any of the other management tools, the CLI may provide the feature you need.
- *Discover other Westermo Switches:* The CLI contains a discovery service similar to what WeConfig provides, but more rudimentary.



Note

You must still be able to login to one switch in order to make use of this service.

- *Secure management:* To access the CLI you must either have physical access to the switch (console port), or use the Secure Shell (SSHv2) application to access the CLI remotely. Secure management is also possible via the Web interface (HTTPS) and SNMP (SNMPv3).
- *Configuration scripting:* With a CLI it is possible to develop automatic configuration scripts, e.g., using the *Expect* automation and testing tool. *Expect* extensions exist for many common scripting languages (Ruby, Perl, Tcl).

As with the Web interface, you must know the IP address of your switch before you can access the CLI remotely via SSH (access via the console port is possible

¹For more information about finding the IP address of your switch we refer to the *Getting Started* guide in [chapter 2](#).

without knowing the switch IP address). To find out the switch IP address you may need to use the WeConfig tool, but once you know it you can do the rest of the management via SSH/CLI.

The WeOS CLI is introduced in [chapter 5](#).

Chapter 4

Management via Web Interface

WeOS supports device management via web interface. Both HTTP and HTTPS¹ are supported. The design is optimised for style sheet and JavaScript² capable web browsers. In addition, the design allows users to access the web interface and all settings *without* a style sheet and JavaScript capable browser, but then with less guidance and support from the user interface.

When using the Web Management Tool you have to be aware of the following:

- Only one user can be logged in at a time (see [section 4.2](#) for more information).
- You are automatically logged out after ten (10) minutes of inactivity (see [section 4.2](#) for more information).
- When you click **Apply** on a page, the settings on that page are immediately activated.
- When you click **Apply** on a page, all settings are stored in the *startup configuration* and therefore survive a reboot (see [chapter 7](#) for more information).

[Section 4.2](#) explains how to access the Web Management Tool and [section 4.3](#) describes the web menu hierarchy. In [section 4.3](#) the *system overview* web pages are presented. Other pages and settings are described per topic in [chapter 8](#) and following chapters.

¹For HTTPS server authentication, a self-signed certificate is used as of WeOS v4.33.0.

²JavaScript is a trademark of Oracle Corporation.

4.1 Document Conventions

Specific conventions for the web part of this document.

<p>Button Text</p>	<p>Buttons are indicated by use of bold type-writer style.</p>
<p>Menu path: Top Item ⇒ Sub Item</p>	<p>For each page the menu path to the page is described with this syntax. It means: First click the <i>Top Item</i> menu item and in the sub-menu revealed, click the <i>Sub Item</i> menu item. See also section 4.3.</p>
<p>Menu path: Top Item ⇒ Sub Item ⇒ Button Text</p> <p>Top Item ⇒ Sub Item ⇒  (ctx)</p>	<p>This is an extension to the <i>Menu path: Top Item ⇒ Sub Item</i> version described above. It tells you to click a button with the text <i>Button Text</i> on the page navigated to by <i>Top Item ⇒ Sub Item</i>.</p> <p>The button may be an icon. In this case the icon is shown. Additionally in parenthesis a sub-context (ctx) may be described which will identify a context on the page, normally identified by its header.</p>

4.2 Logging in

To access the switch through the web interface, enter the appropriate URL (e.g., the factory default IP-address `http://192.168.2.200`) in the address field of your web-browser. You will then be presented to the login page where you fill in the *username* and *password*, see figure 4.1.

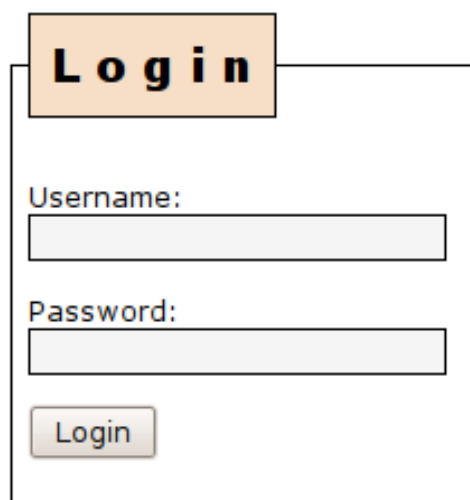

The diagram shows a web login window. At the top, there is a title bar with the word "Login" in bold black text on an orange background. Below the title bar, there are two input fields. The first is labeled "Username:" and the second is labeled "Password:". Both fields are empty and have a light gray background. Below the password field, there is a "Login" button with a light gray background and black text.

Figure 4.1: Web login window

Currently there is only a single user account defined, the *administrator* user account. Note that it is the same user account used for login in CLI. Factory default user account and password are as follows :

- Login: **admin**
- Password: **westermo**

Your web session will last for ten (10) minutes after your latest "web action". Clicking a link or button at least every 10 minutes will let you keep the session forever. The same goes for pages with an automatic refresh option, given that a

refresh interval of 10 minutes or shorter is selected.

Only *one user at a time* can be logged into the switch Web Management Tool. If a new user tries to log in the currently logged in user will automatically be logged out.

4.3 Navigation

After logging in you will be redirected to the *start page*, see [fig. 4.2](#). In the page header you find the menus used to navigate between different tasks. The menu consists of two rows, the *top-menu* row, and the *sub-menu*. For some items you will be presented to a third level sub-menu below the second level sub-menu. Its function is analogously to the second level sub-menu .

To navigate in the menu, click on the *top-menu* to reveal the associated *sub-menu*. Then click on the desired *sub-menu* item. For example, [fig. 4.2](#) shows the selection of top-menu *Status* and sub-menu *Summary* (i.e., Status ⇒ Summary).

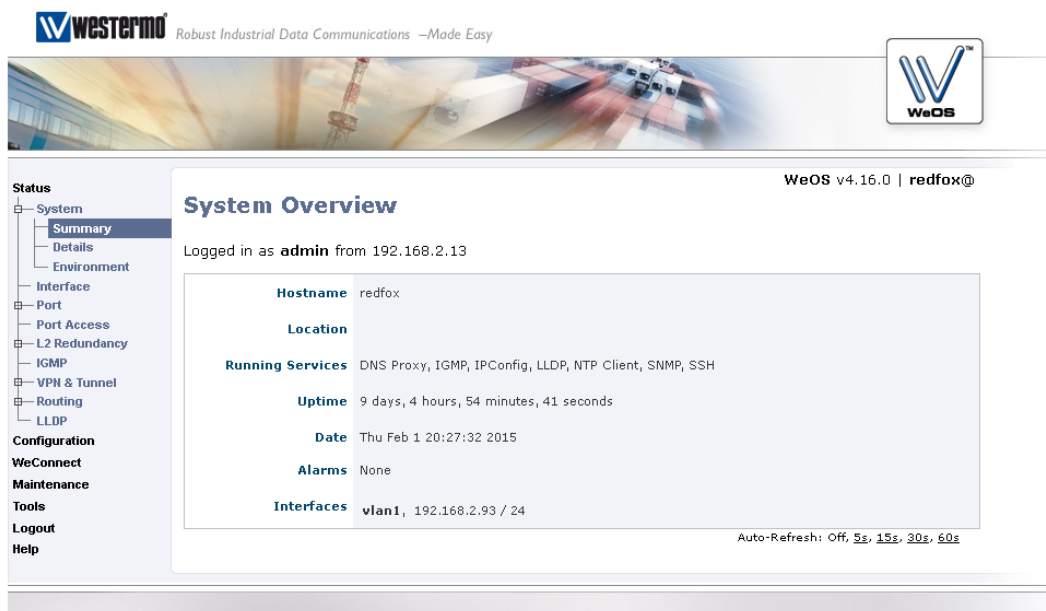

Figure 4.2: Unit Summary - the first page after logging in.

The top-level menu structure is described below:

- Status - This is where you find status information of the running system (port status, protocol status, etc.)
- Configuration - This is where you configure the unit
- Maintenance - This is where you do firmware upgrades, configuration file backups, view log files, etc.

- Tools - Here you find various tools for trouble-shooting and other purposes (e.g., "ping").

Pages where you can change settings generally contains an **Apply** and a **Cancel** button, as shown in [fig. 4.3](#). The semantics of the **Apply** and **Cancel** buttons are provided below:

Apply	Applies the changes on the current page. Changes are applied immediately (i.e., no reboot needed), and are also stored in the startup configuration.
Cancel	Discards changes and either returns to an overview page for the context, or reloads current page and thus shows the current settings.

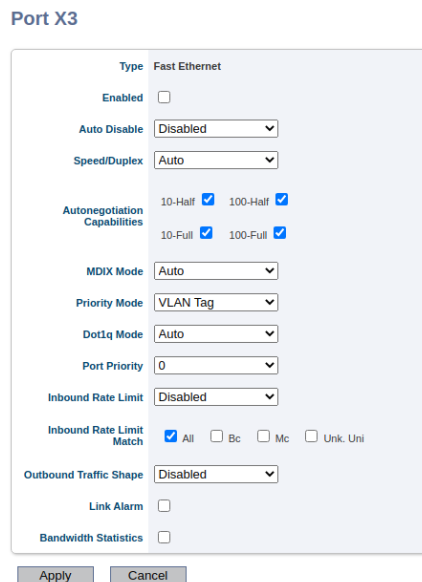

Figure 4.3: Sample web page containing **Apply** and **Cancel** buttons.

Pages with lists of ports may have additional information to display, e.g. if the port is included in a port aggregate or bonded with PAF. This is indicated by the background behind the port label is highlighted as shown in [fig. 4.4](#). When hovering a highlighted port the additional information is displayed in a pop-up. Inside a drop-down menu, the ports are also highlighted, but no pop-ups are presented.

Port Status and Statistics

Port	Link	State	Speed / Duplex	Total Bytes In	Total Bytes Out
1/1	Up	FORWARDING	100 FDX	571244	3026465
1/2	Down	DISABLED		0	0
2/1	Down	DISABLED		0	0
2/2	Down	DISABLED		0	0
2/3	Down	DISABLED		0	0
2/4	Down	DISABLED		0	0

Aggregate A1
-Ports: eth 2/1-2/3

Figure 4.4: Sample web page with port information pop-up.

4.4 System Overview

There are two levels of system information, *summary* and *detailed*.

4.4.1 System Overview - Summary

Menu path: Status ⇒ Summary

Fig. 4.5 shows the first page you will be presented to after logging into the switch. It provides a quick overview of the system, including a list of current alarms.



Figure 4.5: The basic system overview page.

Hostname	An arbitrary name to identify this unit.
Location	An arbitrary description to identify where the unit is located.
ADSL/VDSL Status	Current ADSL/VDSL connection status. Displays negotiation status, IP-address, up/down speed and DSL uptime.
Uptime	The time passed since last reboot of the unit.
Continued on next page	

Continued from previous page	
Date	The current date and time. System time is configured manually or set by using a NTP-server.
Running Services	A list of services currently running on the unit.
Alarms	Currently active port and FRNT alarms. <i>Link alarms</i> are only shown for ports where link alarm is enabled. <i>FRNT alarms</i> are only shown if FRNT is used and FRNT alarm triggers are enabled.
Interfaces	Displays the interfaces and their primary addresses.

4.4.2 System Overview - Detailed

Menu path: Status ⇒ System

To get more information about the switch you go to the detailed page shown in [fig. 4.6](#). This page contains more information on hardware (e.g. versions, article number, etc.) and system status (e.g. memory usage and CPU load).

Hostname	An arbitrary name to identify this unit.
Location	An arbitrary description to identify unit location.
Contact	An arbitrary description to identify a contact person who has more information about management of the unit and the network.
Uptime	The time passed since last reboot of the unit.
Reset counter	The number of times the system has been reboot.
Base MAC Address	The base MAC address defines the starting point of the MAC address range used within the unit. This is a unique number assigned to each unit.
System Default Gateway Address	The operational default gateway for all VLANs on the unit. Either retrieved dynamically or set statically.
Article Number	The article number for the unit.
Main Firmware Version	The version number of the main firmware.
Build Details	The build string of the currently running firmware.
Backup Firmware Version	The version number of the backup firmware.
Main FPGA Version	The version number of the FPGA software.
Boot Loader Version	The version number of the boot loader software.
Serial Number	The units serial number.
Product	The product name.
Model	The product model.
Type	Description for the card in the specified slot.
Article No.	The article number of the card in the specified slot.
Batch ID	The batch identification of the card in the specified slot.
Revision	The revision of the card in the specified slot.
Enabled Redundancy Protocol(s)	A list of the redundancy protocols currently enabled on the unit.

Continued on next page

Continued from previous page	
VLANs With IGMP	A list of VLANs on which IGMP is enabled.
SNMP	Shows if SNMP support is enable or disabled.
Alarms	Currently active port and FRNT alarms. <i>Link alarms</i> are only shown for ports where link alarm is enabled. <i>FRNT alarms</i> are only if FRNT is used and FRNT alarm triggers are enabled.
Configuration Hash	A SHA-1 hash of the running configuration and the saved startup configuration.

System

Hostname	dut
Location	
Contact	
Uptime	0 days, 0 hours, 30 minutes, 26 seconds
Reset counter	17
Base Mac Address	00:07:7c:2e:f0:60
System Default Gateway Address	N/A
Article Number	3643-0105-009
Main Firmware Version	9.99.x
Build Details	\\ Westermo WeOS v4.23.0/4.23.0 -- Mar 6 15:04 CET 2018
Backup Firmware Version	N/A
Boot Loader Version	2014.06.0-1
Serial Number	35317
Product	Lynx
Model	L210-F2G
Platform	Basis
Class	Extended
Card #1	
Type	CPU
Chipset	MV88E6097 r2
Article No.	5011-1110
Batch ID	151102-01607911-00035
Revision	4
Card #2	
Type	POWER
Chipset	N/A
Article No.	5011-1060
Batch ID	151103-01610485-00036
Revision	1
Enabled Redundancy Protocol(s)	None
VLANs With IGMP	vlan1
SNMP	Enabled
Alarms	link-alarm Port 7 DOWN
Configuration Hash	
Startup	c670db9dde7401807c00ef7e7a5b8216863ac6eb
Running	c3ef926793c29f54e7a41809ab91263fcf6a2cc0

Figure 4.6: Detailed system overview page.

4.4.3 System Environment

Menu path: Status ⇒ Environment

To get more information about the system environment variables you go to the environment page.

Environment

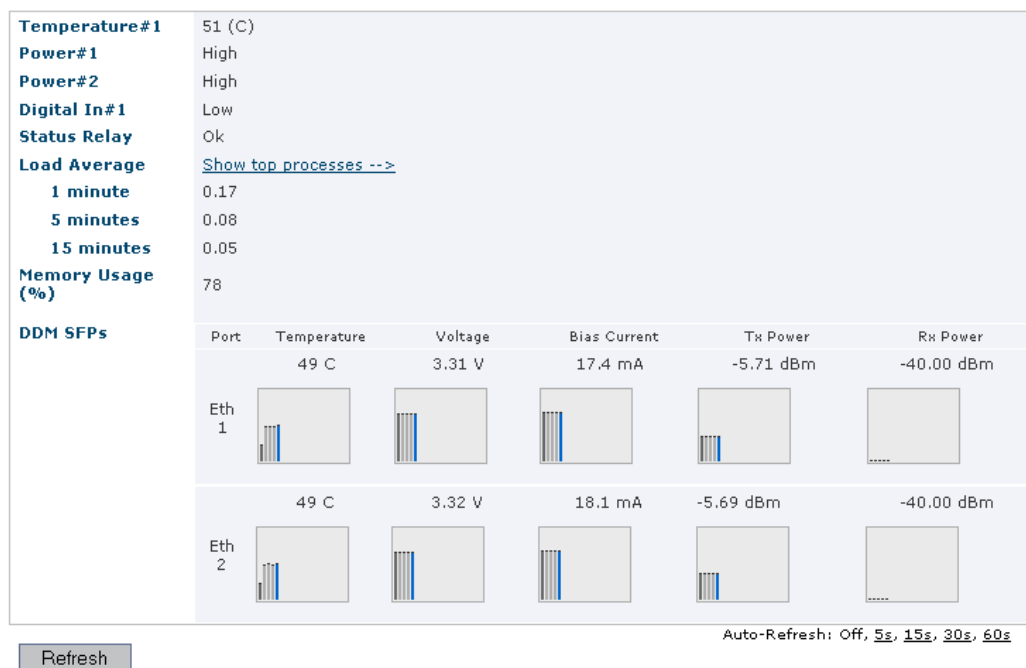

Temperature	Shows system temperature i Celsius(C).
Load Average	The load average is a standard Linux way of measuring system load.
Memory Usage (%)	A snapshot of RAM (Random Access Memory) usage as percentage of total RAM.
Continued on next page	

Continued from previous page

DDM/DOM SFPs ¹	Shows DDM/DOM diagnostics for each SFP. The black bar for each graph represents the first value which was read after boot up, and the blue bar is current value. The DDM/DOM information will be polled for each SFP every twelfth hour. Each graph will then be updated and can consist of up to 20 polled entries. By positioning the mouse over a graph, the user will be presented with startup, max and min value. Please note that each graph shows trend over time and not the absolute value, graphs for different SFP should not be compared.
----------------------------------	--

¹DDM/DOM diagnostic information is only available for Westermo DDM SFPs, see the SFP Transceiver Datasheet of your WeOS product (www.westermo.com).

Chapter 5

Management via Command Line Interface (CLI)

This chapter introduces the command line interface (CLI) tool. Switches running WeOS include a CLI similar to what is provided by other major vendors of network equipment. The CLI provides a more complete set of management features than the Web interface, the WeConfig tool or SNMP. Thus, when advanced management operations are required, the CLI is the management interface of choice.

The CLI can be accessed via the console port, or remotely via secure shell (SSHv2) and Telnet¹.

[Section 5.1](#) introduces the CLI hierarchy and its various contexts. [Section 5.2](#) explains how to access the CLI interface, and [section 5.3](#) provides general information on how to use the CLI.

The last section ([section 5.4](#)) presents CLI commands available in *all* CLI contexts as well as their syntax. Other CLI commands are described per topic in the chapters to follow.

5.1 Overview of the WeOS CLI hierarchy

The WeOS CLI is organised in a hierarchical structure. For management purposes, the use of a hierarchical structure limits the available commands to those relevant for a certain topic. This in turn simplifies switch operation.

¹Telnet server is by default disabled, see also [section 8.3.34](#).

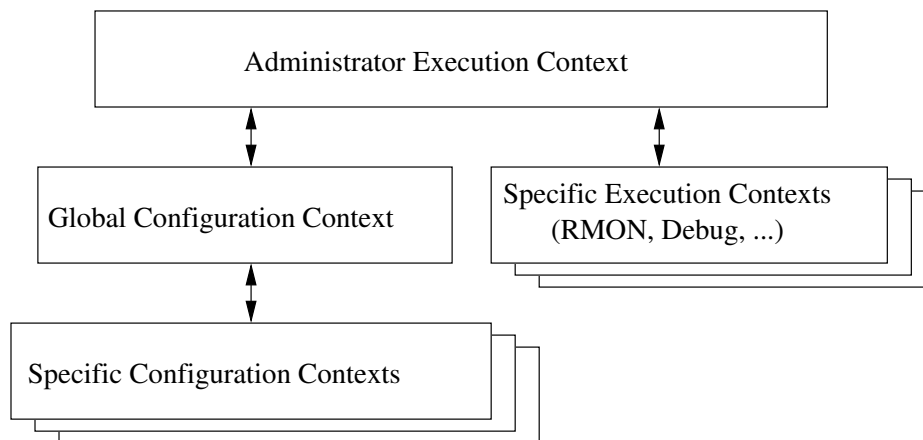

Figure 5.1: CLI hierarchy

Fig. 5.1 shows an overview of the CLI hierarchy. When the user logs in as "admin" the user will enter the CLI with "administrator" privileges in **Admin Exec** context. (In addition to the "admin" user, future versions of WeOS are likely to support a "guest" account with limited privileges.)

Admin Exec context In **Admin Exec** context the user can execute a set of general monitoring and diagnostic functions, and also manage configuration files and firmware versions. From **Admin Exec** context the user can enter a set of specific execution contexts, e.g., to view RMON statistics.

Global Configuration context From the **Admin Exec** context the user can enter the **Global Configuration** context. In **Global Configuration** the user can configure device parameters of global significance, such as *hostname* and *location* of the device. From **Global Configuration** the user can reach contexts specific to certain protocols or device entities such as *port*, *vlan*, *interface*, and *FRNT* contexts.

A simple example on CLI usage is given below. There you can see how the CLI prompt changes to match the current context.

Example

```

example:/#> configure
example:/config/#> vlan 100
example:/config/vlan-100/#> untagged 1,2
example:/config/vlan-100/#> end
example:/config/#> end
example:/#>
  
```

5.2 Accessing the command line interface

To login via the console port you need the username and password. Currently there is only a single user account defined, the *administrator* user account. Factory default account and password:

- Login: **admin**
- Password: **westermo**

The same account is used for management via CLI and Web (see [section 4](#)). To reset the *administrator* password to the default setting, see [chapter 7](#).

5.2.1 Accessing CLI via console port

For WeOS switches equipped with a console port, that port can be used to access the CLI. (For information on which WeOS devices that have a console port, see [section 1.5.1](#)).

 **Console cable**
See the User Guide of your specific product ([section 1.5](#)) for information on what Diagnostic Cable to use when connecting to the console port of your specific product.

Recommended Terminal Emulation programs:

- **Win32:** *PuTTY*, <http://www.chiark.greenend.org.uk/~sgtatham/putty/>
- **UNIX:** There are different terminal emulation programs for different Unix dialects. On Linux *minicom* is recommended.

The following console port settings are used:

Data rate	115200 bits/s
Data bits	8
Stop bits	1
Parity	None
Flow control	None

The example in below shows how to login via the console port using the *PuTTY* application. Once you have installed and started *PuTTY*, configure the appropriate *Serial* settings.

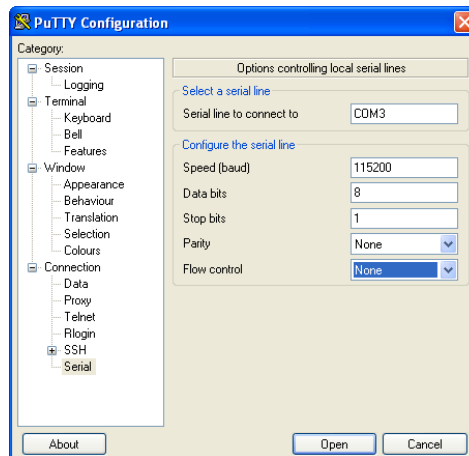

Hint

In this example, the switch is accessible via the logical port "COM3", but the USB/serial adapter may be mapped to a different COM port on your PC. Please check "Ports (COM and LPT)" in the Windows "Device Manager" to get information on what COM port to specify.

When the appropriate serial settings have been configured, select the "Session" view. Select *Serial* as *Connection type* as shown in the figure below.

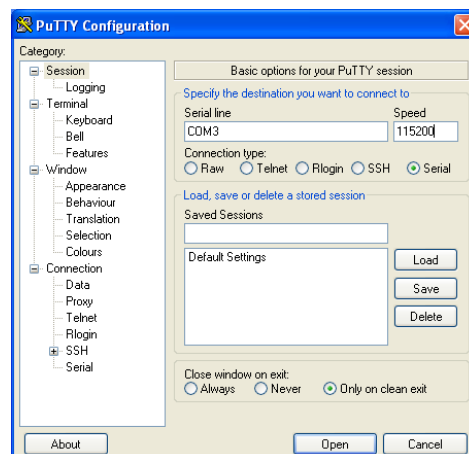

To start the serial connection, press the **Open** button. The figure below shows the console prompt when logging in to the CLI via the console on a unit named *example*.

```
example login: admin
Password:
-----
| | | | - - | - - | - | - - | - | | | | | - |
|-----|-----|-----|-----|-----|-----|
                                www.westermo.com

\\ \ Westermo WeOS v4.15.0 4.15.0 -- Jun 16 19:10 CEST 2014
Type: 'help' for help with commands, 'exit' to logout or leave a context.

example: /#>
```

5.2.2 Accessing the CLI via SSH or Telnet

To gain access to the CLI via SSH you need a *SSH client*, the switch IP address, and the account information (username and password).

Recommended SSH Clients:

- **Win32:** PuTTY, <http://www.chiark.greenend.org.uk/~sgtatham/putty/>
- **UNIX** OpenSSH, <http://www.openssh.com>

The switch IP address can be found using the WeConfig tool, see the WeConfig User Guide[68] (additional methods are listed in [section 7.1.3](#)).

The following example illustrates how to login to the switch using PuTTY from a Windows based host system as user *admin*. In this example, the switch is a WeOS switch with IP address 192.168.2.200 (the factory default IP address). See [section 5.2](#) for information about user accounts and passwords.

In the PuTTY session view, select *SSH* as *Connection type*, and enter the IP address of the switch (here 192.168.2.200).

5.3 Using the CLI

5.3.1 Starting out with the CLI

When first entering the CLI you end up in the *Admin Exec* context. In the *Admin Exec* you can view system *status* information using various **"show"** commands, upgrade system firmware, etc., as well as other functions, which do not affect the system *configuration*.

To be able to modify the switch configuration you should enter the *Global Configuration* context, by using the **"configure"** command as shown below. From the *Global Configuration* you are able to configure system parameters such as its **"hostname"** or its **"date"**.

Example

```
example:/#> configure  
example:/config/#>
```

As described in [section 5.3.2](#) you can reach other, specific configuration contexts from the *Global Configuration* context.

Example

```
example:/#> configure  
example:/config/#> vlan 100  
example:/config/vlan-100/#> untagged 1/1,1/2  
example:/config/vlan-100/#> end  
example:/config/#> end  
example:/#>
```

To get help on what commands are available in the current context, use the **"help"** command (see example in [fig. 5.2](#)). First the context specific configuration commands are shown, followed by the commands to *show* the current configuration settings. At the end, commands available in all contexts are shown (see also [section 5.4.](#)).

```

Example
example:/config/vlan-100/#> help
Available Commands
=====
enable          Enable, or disable this VLAN
name <ARG>      Set name of VLAN
tagged <ARG>    Set tagged ports
untagged <ARG>  Set untagged ports
channel <ARG>   Set VLAN channel interface
priority <ARG>  Set VLAN priority, overrides port priority
igmp            Enable, or disable IGMP Snooping

show enable     Show if VLAN is active or not
show name       Show name of VLAN
show tagged     Show tagged ports
show untagged   Show untagged ports
show channel    Show VLAN channel interface
show priority   Show VLAN priority setting
show igmp       Show IGMP Snooping status

no <ARG>        Prefix, used to disable services or settings.
do              Shortcut to EXEC mode, e.g. do ping <IP>.
end             Save settings and return to previous mode.
leave           Save settings and return to EXEC mode.
abort          Cancel all changes and leave this mode.
show <ARG>      Show summary, or status.
repeat <ARG>    Repeat next command every second, until Ctrl-C
help <ARG>      This help text.
tutorial        Brief introduction to the CLI
=====
<ARG> - Command takes argument(s), see help <command> for further information.
Short forms of commands are possible, see the tutorial for more help.
example:/config/vlan-100/#>

```

Figure 5.2: Use of the "help" command to list available commands (here in the VLAN context).

The "help" command can also be used to get information on a specific command as shown below.

```

Example
example:/config/vlan-100/#> help igmp
Syntax:
    [no] igmp

Description:
    Enable, or disable IGMP Snooping

```

```
=====
The [no] keyword is when you want to disable a service or remove a property.
example:/config/vlan-100/#>
```

The CLI supports basic *TAB-completion*, which can come in handy when you do not know the exact command name, e.g., writing "**fi[TAB]**" within the *IP* context will expand to "**firewall**".

TAB-completion is only able to expand the full command when there is no ambiguity. Otherwise the available alternatives will be listed.

Example

```
example:/#> d[TAB]
do      debug  date    dir     delete
example:/#> d
```

Furthermore, when there is no ambiguity it is possible to use an abbreviation of a command instead of the full command (i.e., without using *TAB-completion*).

Example

```
example:/#> con
example:/config/#>
```

5.3.2 Entering and leaving CLI contexts

Fig. 5.3 gives a general overview of how to enter and leave the various context in the CLI hierarchy. The commands to move between contexts are further discussed in the text below.

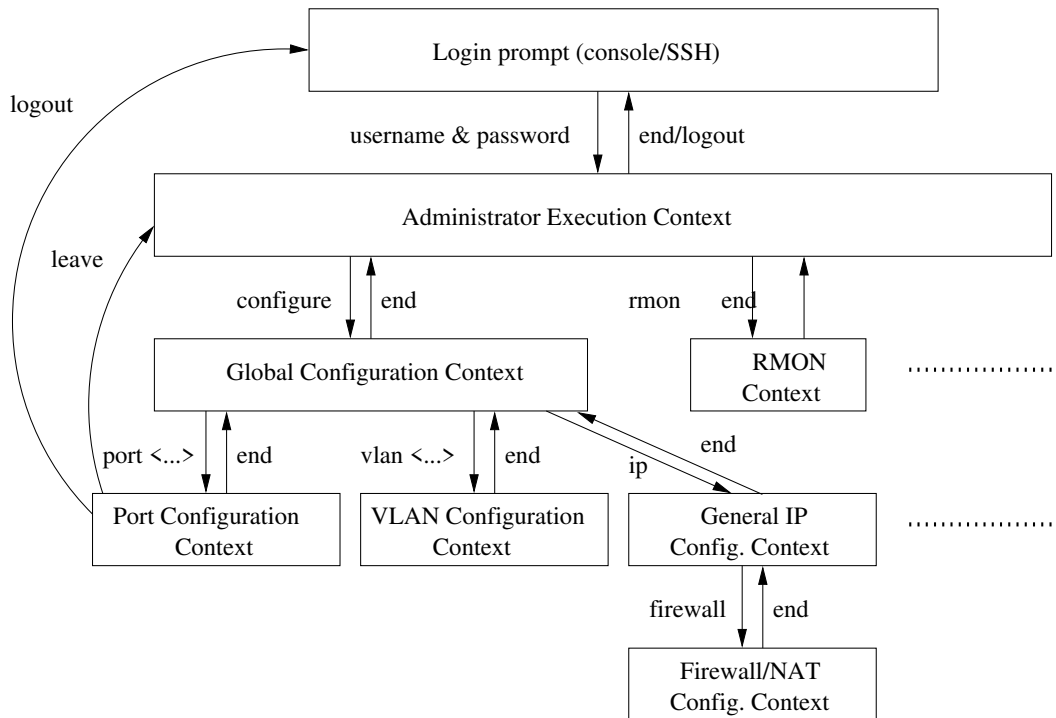

Figure 5.3: Moving between CLI contexts. Only a subset of the available contexts is shown. Although not shown, the *leave* and *logout* commands can be used from all contexts.

To enter **Global Configuration** context from **Admin Exec** context, the **"configure"** command is used. From **Global Configuration** context one can reach several specific configuration contexts, and the command to enter them is context specific, e.g.,:

- vlan <VID>** Manage VLAN settings for VLAN with given VID.
- port <PORT>** Manage port settings for port with given PORT identifier.
- interface <IFNAME>** Manage settings for the given network interface.

By entering the **Global Configuration** context the user is able to interactively change the device configuration, however, configuration changes will not take

effect until the user leaves the configuration contexts and returns to the [Admin Exec](#) context via the **"end"** or **"leave"** commands.

When the user returns to [Admin Exec](#) context, the *running-configuration* of the switch will be updated. To make the configuration changes permanent the *running-configuration* should be saved to the *startup-configuration* using the **"copy"** command, see also [chapter 7](#).

It is also possible to leave the configuration contexts without updating the *running-configuration*. The commands to leave a context are listed below. More information on these and other general CLI commands can be found in [section 5.4](#).

end	Confirms configuration changes conducted in this context and returns to the context immediately above. If issued within the Global Configuration context, the user returns to the Admin Exec context and the <i>running-configuration</i> is updated.
exit	An alias for end.
leave	Confirms configuration changes made and returns to Admin Exec context. The <i>running-configuration</i> is updated.
Ctrl-Z	An alias for leave. Ends your configuration session and returns to Admin Exec context.
abort	Discards configuration changes conducted in this context and returns to the context immediately above. If issued within the Global Configuration context, the user returns to the Admin Exec context without updating the <i>running-configuration</i> . If issued in Admin Exec context it works the same as logout.
Ctrl-D	An alias for abort. Blocked if any text is already input on the command line.
logout	Log out from the CLI. If conducted from within any of the configuration contexts, all configuration changes are discarded (i.e., the <i>running configuration</i> is not updated).

5.3.3 CLI command conventions

This section describes the CLI command conventions used within this guide. The syntax for a sample set of CLI commands is shown below:

- [no] default-gw <ADDRESS>
- igmp-interval <12|30|70|150>
- show iface [IFNAMELIST]

Convention	Description
command syntax	Command syntax is generally written in typewriter style (fixed width)
"command syntax"	Commands described in running text use bold typewriter style enclosed by quotation marks.
UPPERCASE	A variable parameter. Enter value according to the description that follows.
lowercase	A keyword parameter. Enter value according to the given syntax.
	Vertical bar. Used to separate alternative (mutually exclusive) parameters.
< >	Angle brackets. Encloses a mandatory parameter.
[]	Squared brackets. Encloses an optional parameter.
[< >]	Angle brackets within squared brackets. Encloses a mandatory parameter within an optional choice.

5.4 General CLI commands

The majority of the CLI commands are specific to a certain context, however, there is a set of CLI commands available in all contexts. These commands are explained further here. The **"configure"** command used to enter the [Global Configuration](#) context from the [Admin Exec](#) context, is also covered.

Command	Section
no <COMMAND>	Section 5.4.1
do	Section 5.4.2
end	Section 5.4.3
leave	Section 5.4.4
abort	Section 5.4.5
logout	Section 5.4.6
repeat <COMMAND>	Section 5.4.7
help [COMMAND]	Section 5.4.8
tutorial	Section 5.4.9
configure [terminal]	Section 5.4.10

5.4.1 Negate/disable a setting

Syntax no <COMMAND>

Context All contexts

Usage Depending on context the **"no"** command disables or resets a setting to default.

Primarily used within configuration contexts to negate or disable a configuration setting, e.g., in *port* context **"no flow-control"** disables flow control. For some commands, "no" is used to reset to a default value, e.g., **"no polling-interval"** (NTP client context) sets the NTP polling-interval to its default value (600 seconds).

The **"no"** command can also be used to negate/disable certain commands outside the *configuration* context, e.g., to disable debugging or port monitoring.

Default values Not applicable

5.4.2 Execute (do) command from Admin Exec context

Syntax do <COMMAND>

Context All contexts

Usage Use the "do <COMMAND>" to execute a COMMAND available in [Admin Exec](#) context from any context.

For example, when located in [Global Configuration](#) context, the user could run "do show running-config" to see the *running configuration*, or run "do ping 192.168.1.1" to "ping" IP address 192.168.1.1.

Default values Not applicable

5.4.3 End context

Syntax end

Context All contexts

Usage Leave this context and return to the context immediately above. If this command is issued within any of the configuration contexts, the command implies that the configuration changes conducted within that context are confirmed. If the command is issued in the [Global Configuration](#) context, the user returns to the [Admin Exec](#) context, and the *running-configuration* is updated.

Default values Not applicable

5.4.4 Leave context

Syntax leave

Context All contexts

Usage Leave this context and return to the [Admin Exec](#) context. If this command is issued within any of the configuration contexts, the command implies that the configuration changes conducted are confirmed, and the *running-configuration* is updated.

Default values Not applicable

5.4.5 Abort context

Syntax abort

Context All contexts

Usage Leave this context and return to the context immediately above. If this command is issued within any of the configuration contexts, the command implies that the configuration changes conducted within that context are discarded. If the command is issued in the [Global Configuration](#) context, the user returns to the [Admin Exec](#) context without updating the *running-configuration*.

Default values Not applicable

5.4.6 Logout

Syntax logout

Context All contexts

Usage Logout from system. If this command is issued within any of the configuration contexts, the command implies that the configuration changes conducted are discarded, i.e., the *running-configuration* is not updated.

Default values Not applicable

5.4.7 Repeat a command

Syntax repeat <COMMAND>

Context [Admin Exec](#) context

Usage Repeat COMMAND every second until Ctrl-C is pressed.

Default values Not applicable

5.4.8 On-line help

Syntax help <COMMAND>

Context All contexts

Usage Show help information specific to a certain context, or a specific command.

Default values If no COMMAND is specified, help information related to the current context is shown.

5.4.9 CLI tutorial

Syntax tutorial

Context All contexts

Usage Show CLI tutorial text.

Default values Not applicable

5.4.10 Entering Global Configuration Context

When a user logs in to the CLI the user will enter the [Admin Exec](#) context. In [Admin Exec](#) context the user can view status information and have access to tools such as *ping* and *traceroute*, but is not able to perform any configuration. To configure the device, the user can use the *configure* command to enter the Global Configuration context.

Syntax configure [terminal]

Context [Admin Exec](#) context

Usage Enter Global Configuration context.

The optional `terminal` argument is a compatibility keyword, for advanced users. It disables all safe guards (yes-or-no questions), making it possible to paste-in configuration files into the terminal.

Pasting in configuration files can also be done with the `copy` command as `copy con run` to copy *console* to *running-config*.

Default values Interactive mode (i.e. the **"terminal"** argument does not apply by default)

Chapter 6

WeOS SNMP Support

The Simple Network Management Protocol (SNMP) provides a standardised method to manage and monitor IP devices remotely. The WeOS SNMP agent supports SNMP v1, v2c and v3.

6.1 Introduction and feature overview

[Table 6.1](#) shows WeOS SNMP control features for the Web and CLI interfaces. Further description of the SNMP support is presented in the [sections 6.1.1-6.1.6](#). If you are only interested in knowing how to manage SNMP features via the Web or CLI, please visit [sections 6.2](#) or [6.3](#) directly.

6.1.1 SNMP introduction

The Simple Network Management Protocol (SNMP) provides a standardised method to manage and monitor IP devices remotely. In SNMP a *manager station* can manage a set of status and configuration objects via an *SNMP agent* on the management unit. The WeOS SNMP agent supports SNMP v1, v2c and v3.

An SNMP manager:

- can send SNMP *GET* messages to poll status and configuration information from an *SNMP agent*.
- can send SNMP *SET* messages to the *SNMP agent* to modify the device settings (or issue commands such as 'reboot').

Feature	Web	CLI	General Description
<u>General</u>			
Enable/disable SNMP	X	X	
<u>SNMPv1/v2c</u>			
Read Community	X	X	Sec. 6.1.2
Write Community	X	X	"
Trap Community	X	X	Sec. 6.1.2-6.1.3
Trap Host	X	X	Sec. 6.1.3
<u>SNMPv3</u>			
Read-Only SNMPv3 User	X	X	Sec. 6.1.4
Read/Write SNMPv3 User	X	X	"

Table 6.1: WeOS control of SNMP features.

- can get notified by an agent when specific events occur, such as link down event, via SNMP *TRAP* messages.

The objects manageable via SNMP are defined in a management information base (MIB). The WeOS MIB support aims at providing SNMP management primarily via standard MIBs to enable easy integration with existing SNMP management tools. In addition, WeOS includes an enterprise MIB (private MIB) to provide access to MIB objects not available via the standard MIBs.

6.1.2 SNMP Communities

An SNMP *community* is a relationship between the manager and managed station. It can be seen as a (very) basic authentication and authorisation mechanism for SNMP v1 and v2c¹. Three types of communities are supported:

- *Read community*: The SNMP read community is used by a manager to read SNMP MIB objects from a managed station.

Default read community: `Public`

- *Write community*: The SNMP write community can be used to write (and read) SNMP MIB objects to (from) a managed station. Thus, if the agent has its write community enabled, it is possible to configure the switch via SNMP. The write community is typically named **"private"**.

¹See section 6.1.4 for secure management using SNMPv3.

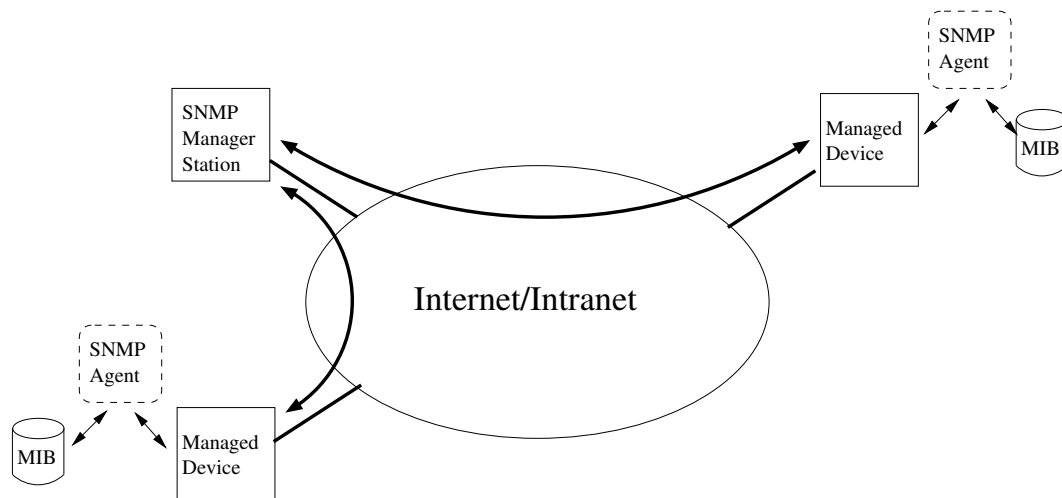

Figure 6.1: Sample SNMP setup, where one manager station controls two devices by communicating with SNMP agents running on the managed devices.

Default write community: Disabled

- *Trap community*: The SNMP trap community is used when an agent wants to send a notification to the manager (SNMP Trap). The trap community is typically named **"public"**.

Default trap community: trap



Warning

Using the well-known community strings "public" and "private" could pose a serious security problem.

6.1.3 Trap Support

SNMP traps are only generated if there is at least one *Trap Host* (i.e., SNMP management station) defined. Up to three *Trap Hosts* can be defined. If two or more *Trap Hosts* are configured, traps will be sent to all of them.

The WeOS SNMP trap support is integrated with the WeOS alarm handling system (see [section 25.1](#)). This means that you as an operator have fine-grained control of which traps to send. All traps in the list below, except *Coldstart* and *IldpRemTablesChange*, can be controlled via the alarm handling system.

- **Link Alarm:** A trap is generated on *link up* or *link down*, given that *Link Alarm* is enabled on that specific port (see [sections 25.1.3](#) and [10.1.5](#)).

Link Down OID: iso(1).org(3).dod(6).internet(1).snmpV2(6).snmpModules(3).snmpMIB(1).snmpMIBObjects(1).snmpTraps(5).linkDown(3)

Link Up OID: iso(1).org(3).dod(6).internet(1).snmpV2(6).snmpModules(3).snmpMIB(1).snmpMIBObjects(1).snmpTraps(5).linkUp(4)

 **Note**

When a port is being reconfigured, link down and link up events are likely to occur. If *link-alarm* is enabled on that port, a couple of SNMP traps are likely to be generated as a side-effect of the port reconfiguration.

- **Cold Start:** A trap is generated when a system comes up.

OID: iso(1).org(3).dod(6).internet(1).snmpV2(6).snmpModules(3).snmpMIB(1).snmpMIBObjects(1).snmpTraps(5).coldStart(1)

- **LLDP Remote System Update:** A trap is generated when a remote system has updated.

OID: iso(1).std(0).iso8802(8802).ieee802dot1(1).ieee802dot1mibs(1).lldpMIB(2).lldpNotifications(0).lldpNotificationPrefix(0).lldpRemTablesChange(1)

- **Digital-In:** A trap is generated when the voltage level on the pins of a digital-in sensor changes from *high* to *low*, or *low* to *high*.

Digital-In High OID: iso(1).org(3).dod(6).internet(1).private(4).enterprises(1).westermo(16177).common(2).weos(1).notifications(6).sensorNotifications(1).sensorNotificationPrefix(0).digitalInHigh(1)

Digital-In Low OID: iso(1).org(3).dod(6).internet(1).private(4).enterprises(1).westermo(16177).common(2).weos(1).notifications(6).sensorNotifications(1).sensorNotificationPrefix(0).digitalInLow(2)

- **Power Supply:** A trap is generated when the voltage level on any of the power feeds changes from *high* to *low*, or *low* to *high*.

Power Supply High OID: iso(1).org(3).dod(6).internet(1).private(4).enterprises(1).westermo(16177).common(2).weos(1).notifications(6).sensorNotifications(1).sensorNotificationPrefix(0).powerSupplyHigh(3)

Power Supply Low OID: *iso(1).org(3).dod(6).internet(1).private(4).enterprises(1).westermo(16177).common(2).weos(1).notifications(6).sensorNotifications(1).sensorNotificationPrefix(0).powerSupplyLow(4)*

- **Temperature:** A trap is generated when the temperature measured by a built-in temperature sensor reaches the configured rising or falling thresholds.

Temperature High OID: *iso(1).org(3).dod(6).internet(1).private(4).enterprises(1).westermo(16177).common(2).weos(1).notifications(6).sensorNotifications(1).sensorNotificationPrefix(0).temperatureHigh(5)*

Temperature Low OID: *iso(1).org(3).dod(6).internet(1).private(4).enterprises(1).westermo(16177).common(2).weos(1).notifications(6).sensorNotifications(1).sensorNotificationPrefix(0).temperatureLow(6)*

- **FRNT Ring Status:** A trap is generated when a unit detects a change of FRNT ring status, i.e., ring up (OK) or ring down (Broken).

FRNTv0 Ring Up OID: *iso(1).org(3).dod(6).internet(1).private(4).enterprises(1).westermo(16177).common(2).weos(1).notifications(6).frntNotifications(2).frntNotificationPrefix(0).frntRingUp(1)*

FRNTv0 Ring Down OID: *iso(1).org(3).dod(6).internet(1).private(4).enterprises(1).westermo(16177).common(2).weos(1).notifications(6).frntNotifications(2).frntNotificationPrefix(0).frntRingDown(2)*

FRNTv2 Ring Up OID: *iso(1).org(3).dod(6).internet(1).private(4).enterprises(1).westermo(16177).common(2).frnt(5).frntNotifications(3).frntNotificationPrefix(0).frntRingBroken(2)*

FRNTv2 Ring Down OID: *iso(1).org(3).dod(6).internet(1).private(4).enterprises(1).westermo(16177).common(2).frnt(5).frntNotifications(3).frntNotificationPrefix(0).frntRingOK(1)*

- **RiCo and Dual-Homing Uplink Status:** A trap is generated when a unit detects a change of RiCo Uplink Status or Dual-Homing Uplink Status, i.e., uplink status up, or uplink status down.

RiCo/Dual-Homing Uplink Up OID: *iso(1).org(3).dod(6).internet(1).private(4).enterprises(1).westermo(16177).common(2).weos(1).notifications(6).riCoNotifications(8).riCoNotificationPrefix(0).riCoUplinkUp(1)*

RiCo/Dual-Homing Uplink Down OID: *iso(1).org(3).dod(6).internet(1).private(4).enterprises(1).westermo(16177).common(2).weos(1).notifications(6).*

riCoNotifications(8).riCoNotificationPrefix(0).riCoUplinkDown(2)

- **SNR-margin:** On units with a SHDSL/xDSL port traps are generated when the SNR margin falls below (or rises above) a configurable threshold.

OID: iso(1).org(3).dod(6).internet(1).mgmt(2).mib-2(1).transmission(10).hds12ShdslMIB(48).hds12ShdslNotifications(0).hds12ShdslSNRMarginCrossing(2)

- **LFF Status:** On units with SHDSL ports, a trap is generated when a unit detects a change in the Link Fault Forward (LFF) status on a SHDSL port, i.e., if the remote end reports that its Ethernet port is up or down.

LFF Remote Up OID: iso(1).org(3).dod(6).internet(1).private(4).enterprises(1).westermo(16177).common(2).weos(1).notifications(6).lffNotifications(3).lffNotificationPrefix(0).lffRemoteUp(1)

LFF Remote Fail OID: iso(1).org(3).dod(6).internet(1).private(4).enterprises(1).westermo(16177).common(2).weos(1).notifications(6).lffNotifications(3).lffNotificationPrefix(0).lffRemoteFail(2)

- **PoE total power consumption:** On units with Ethernet ports supporting Power over Ethernet, traps are generated with the total consumed power rises above (or falls below) a configurable threshold.

Power consumption above threshold OID: iso(1).org(3).dod(6).internet(1).mgmt(2).mib-2(1).powerEthernetMIB(105).pethNotifications(0).pethMainPowerUsageOnNotification(2)

Power consumption below threshold OID: iso(1).org(3).dod(6).internet(1).mgmt(2).mib-2(1).powerEthernetMIB(105).pethNotifications(0).pethMainPowerUsageOffNotification(3)

- **Address Conflicts:** On units configured with alarm trigger to detect address conflicts, traps are generated as: *Detected*, a new conflict is detected (with details). *Cleared*, a conflict is cleared (with details). *Warning*, at least one conflict. *OK*, no conflict is detected.

Address Conflict Detected OID: iso(1).org(3).dod(6).internet(1).private(4).enterprises(1).westermo(16177).common(2).weos(1).notifications(6).addressConflictNotifications(6).addressConflictNotificationsPrefix(0).AddressConflictDetected(1)

Address Conflict Cleared OID: iso(1).org(3).dod(6).internet(1).private(4).enterprises(1).westermo(16177).common(2).weos(1).notifications(6).

addressConflictNotifications(6).addressConflictNotificationsPrefix(0).AddressConflictCleared(2)

Address Conflict OK OID: iso(1).org(3).dod(6).internet(1).private(4).enterprises(1).westermo(16177).common(2).weos(1).notifications(6).addressConflictNotifications(6).addressConflictNotificationsPrefix(0).AddressConflictOK(3)

Address Conflict Warning OID: iso(1).org(3).dod(6).internet(1).private(4).enterprises(1).westermo(16177).common(2).weos(1).notifications(6).addressConflictNotifications(6).addressConflictNotificationsPrefix(0).AddressConflictWarning(4)

- **Ping Trigger:** A trap is generated when the status for a Ping Trigger is changed.

Ping Trigger OK OID: iso(1).org(3).dod(6).internet(1).private(4).enterprises(1).westermo(16177).common(2).weos(1).notifications(6).pingNotifications(9).pingNotificationPrefix(0).pingTriggerOk(1)

Ping Trigger Warning OID: iso(1).org(3).dod(6).internet(1).private(4).enterprises(1).westermo(16177).common(2).weos(1).notifications(6).pingNotifications(9).pingNotificationPrefix(0).pingTriggerWarning(2)

- **Summary Alarm Status:** The summary alarm status (*summaryAlarmStatus*) follows the status of the ON LED:
 - when the ON LED turns *red*, the *summaryAlarmStatus* has value *Warning (1)*.
 - when the ON LED turns *green*, the *summaryAlarmStatus* has value *OK (2)*.

It is possible to get SNMP traps when the summary Alarm Status changes state (see [section 25.3.17](#) for information of how to enable summary alarm traps). When enabled, a *summaryAlarmOK* trap is sent when the ON LED turns *green*, and a *summaryAlarmWarning* trap is sent when it turns *red*.

Summary Alarm OK OID: iso(1).org(3).dod(6).internet(1).private(4).enterprises(1).westermo(16177).common(2).weos(1).notifications(6).genericNotifications(4).genericNotificationPrefix(0).summaryAlarmOK(1)

Summary Alarm Warning OID: iso(1).org(3).dod(6).internet(1).private(4).enterprises(1).westermo(16177).common(2).weos(1).notifications(6).

genericNotifications(4).genericNotificationPrefix(0).summaryAlarmWarning(2)

The summary alarm status can be read at the following OID:
iso(1).org(3).dod(6).internet(1).private(4).enterprises(1).westermo(16177).common(2).weos(1).system(5).eventSystem(2).summaryAlarmStatus(1)

- **MRP Ring Status:** A trap is generated when a unit detects a change of MRP ring status, i.e., ring closed (OK) or ring open (Broken).

MRP Ring Closed OID: *iso(1).org(3).dod(6).internet(1).private(4).enterprises(1).westermo(16177).common(2).weos(1).notifications(6).otherNotifications(7).otherNotificationPrefix(0).mrpRingClosed(3)*

MRP Ring Open OID: *iso(1).org(3).dod(6).internet(1).private(4).enterprises(1).westermo(16177).common(2).weos(1).notifications(6).otherNotifications(7).otherNotificationPrefix(0).mrpRingOpen(4)*

6.1.4 Secure management using SNMPv3

To manage a unit securely via SNMP, SNMPv3 should be used. SNMPv3 provides privacy and integrity (per packet authentication) to the SNMP messages.

SNMPv3 introduces the notion of a SNMPv3 *user*, as opposed to the *community* concept used in SNMPv1/v2c. The following parameters can be configured for an SNMPv3 user.

- Read-Only or Read-Write access: Defines whether the *user* should have *read* access to the SNMP variables, or be able to *read* and *modify* them.
- Security Mode: Three security modes are available:
 - *noAuthNoPriv*: No security (i.e., neither authentication, nor encryption)
 - *authNoPriv*: Authentication, but no privacy.
 - *authPriv*: Authentication and Encryption

Note

As of WeOS v4.33.0, the WeOS SNMP agent accepts SNMP requests of security level *authNoPriv* also for SNMPv3 users created at level *authPriv*. A stricter behaviour, where requests of security level *authNoPriv* will be discarded for SNMPv3 users created at level *authPriv*, may be implemented in future releases of WeOS.

- Encryption protocol: WeOS offers SNMPv3 data encryption using DES and AES-128.
- Authentication protocol: WeOS offers SNMPv3 data integrity using MD5 and SHA1.
- Scope: A user can be restrained to only access a part of the MIB tree supported by the unit.

The encryption and authentication passwords are strings of 8-16 characters. ASCII characters 33-126 except '#' (ASCII 35) are allowed.

A maximum of 8 SNMPv3 users can be defined, each with their own parameter set.

6.1.4.1 SNMPv3 example

This example illustrates the configuration of an SNMPv3 user on the a WeOS switch. The user *alice* is granted *read-only* access to the full MIB tree. Security level *authNoPriv* is used where SHA1 is used as authentication protocol.

Example

```
example:/#> configure
example:/config/#> snmp-server
example:/config/snmp/#> rouser alice auth sha1 alicepwd
example:/config/snmp/#> leave
example:/#> cp running start
```

Section 6.1.6 lists recommended SNMP management software. Those tools have graphical user interfaces and should be straight forward to use. For a simple test you could also use the (Unix) Net-SNMP "**snmpwalk**" command. (Here it is assumed that the switch is accessible on IP address *192.168.2.200* and the "walk" is limited to the mib-2 system's group).

Example

```
mypc:~$ snmpwalk -v3 -u alice -l authNoPriv -a SHA -A alicepwd 192.168.2.200 system
SNMPv2-MIB::sysDescr.0 = STRING: Westermo RedFox Industrial, primary: v4.4.0, backup: v4.
bootloader: v2.01, fpga: v20080626
SNMPv2-MIB::sysObjectID.0 = OID: SNMPv2-SMI::enterprises.16177
DISMAN-EVENT-MIB::sysUpTimeInstance = Timeticks: (94018) 0:15:40.18
SNMPv2-MIB::sysContact.0 = STRING:
SNMPv2-MIB::sysName.0 = STRING: redfox
SNMPv2-MIB::sysLocation.0 = STRING:
```



```
SNMPv2-MIB::sysServices.0 = INTEGER: 79
SNMPv2-MIB::sysORLastChange.0 = Timeticks: (0) 0:00:00.00
mypc:~$
```

6.1.5 Supported MIBs

6.1.5.1 Standard MIBs

As of WeOS v4.33.0 the following standard MIBs are supported²:

- RFC1213 MIB-2: The original MIB-2 standard MIB.
- RFC2863 Interface MIB: The *ifXTable* of the IF-MIB is supported.
- RFC2819 RMON MIB: RMON Ethernet statistics (*etherStatsTable*) is supported.
- RFC3411 SNMP Framework MIB
- RFC4188 Bridge MIB
- RFC4318 RSTP MIB
- RFC4363 Q-BRIDGE MIB: The *dot1qVlan* group and *dot1qVlanStaticTable* are supported, enabling support for static VLAN configuration.
- RFC4836 MAU MIB: The *dot3IfMauBasicGroup* and *dot3IfMauAutoNegGroup* of the MAU MIB are supported.
- RFC3635 Ether-like Interface MIB: The *dot3StatsTable* is supported, enabling monitoring of various error counters for Ethernet ports.
- RFC4133 Entity MIB: The *entityPhysical* group of the Entity MIB is supported. It can be used to read unit serial number, firmware version, etc.
- RFC3433 Entity Sensor MIB: The Entity Sensor MIB can be used to monitor the status of unit sensors for temperature, power supply, and "digital-in", etc.
- RFC 4319 HDLSL2/SHDSL MIB: On products with SHDSL ports, the *hdsI2ShdsISpanConfTable*, *hdsI2ShdsISpanStatusTable*, *hdsI2ShdsIInventoryTable* and *hdsI2ShdsISpanConfProfileTable* are supported (read-only).
- RFC 3621 Power Ethernet MIB: The PoE MIB is supported on products with PoE ports.

²Indications of level of support for each MIB is shown in the list of supported MIBs. For some MIBs, you find more detailed MIB conformance information in the WeOS release zip-archive.

- IEEE 802.1AB LLDP MIB: Partial support for *IldpConfigGroup*, *IldpConfigTxGroup*, *IldpStatsRxGroup*, *IldpStatsTxGroup*, *IldpLocSysGroup*, and *IldpRemSysGroup* of IEEE 802.1AB-2005 LLDP MIB.
- IEEE 802.1AX LAG MIB: Support for *dot3adAggPortListGroup*, and partial support for *dot3adAggGroup* and *dot3adAggPortGroup* of IEEE 802.1AX-2014 Link Aggregation MIB (LAG MIB).
- RFC2787 VRRPv2 MIB: The *vrrpOperations* group is supported (read-only).
- RFC6527 VRRPv3 MIB: The *vrrpv3Operations* group is supported (read-only).
- IEC 62439-2 MRP MIB: The following groups are partially supported (read-only): *mrpDomainBasicGroup*, *mrpDomainDiagGroup*, *mrpDomainAdvancedGroup*, *mrpDomainManagerGroup* and *mrpDomainBlockingCntrlGroup*.
- IEC 61375-2-5 TTDP MIB: The TTDP MIB is supported on RFR-212-FB[60], with some adjustments for errors in the MIB file.
- UCD SNMP MIB: Applicable objects in the *memory* branch of the *ucdavis* module are supported. This MIB can be used to monitor system memory usage, and is maintained by the Net-SNMP Project³.

6.1.5.2 Private MIB

To use the WeOS private MIB, a set of Westermo specific MIB files should be loaded into your SNMP management software (see [section 6.1.6](#) for information on recommended management software):

- WESTERMO-MIB: Defines the top level objects of the Westermo Private MIB name space.
- WESTERMO-WEOS-MIB: Defines the WeOS4 branch of the Westermo Private MIB.
- WESTERMO-FRNT-MIB: This MIB is shared between WeOS4 and WeOS5. It defines a generic FRNT MIB module within the Westermo Private MIB. It provides MIB objects for both FRNTv0 and FRNTv2. FRNTv0 objects can also be accessed in the in WESTERMO-WEOS-MIB.
- WESTERMO-INTERFACE-MIB: This MIB is shared between WeOS4 and WeOS5. It defines an Interface MIB module within the Westermo Private MIB. The MIB lists all ports and interfaces and their reference index. The purpose of this reference index is to have a predictable index for ports and interfaces.

³<http://www.net-snmp.org>

6.1.6 Recommended Management Software

The following SNMP managers are recommended:

- OidView from ByteSphere⁴.
- MG-SOFT MIB Browser Pro. from MG-SOFT⁵.
- SNMPc from Castlerock Computing⁶.

6.1.7 WeOS ifIndex allocation

SNMP *ifIndex* is used in various SNMP MIBs as reference to specific interfaces, be it Ethernet ports, VLAN interfaces or higher layer network interfaces. In particular, the *ifTable* and *ifXTable* of MIB-2 and IF-MIB make use of the *ifIndex* when listing the available interfaces on the WeOS unit.

Note
As a general recommendation, it is strongly discouraged to put any semantic interpretation on the *ifIndex* allocated for interfaces on a WeOS unit. Management systems should **not be hard-coded** expecting that a specific interface is always assigned a certain *ifIndex*.

This said, there may be situations where knowledge about WeOS algorithm to allocate *ifIndex*s can be valuable. Sections 6.1.7.1 and 6.1.7.2 gives a brief description of default *ifIndex* allocation and mechanisms to control the *ifIndex* allocation in WeOS v4.33.0.

Note
The *ifIndex* allocation behaviour may change in future releases of WeOS.

6.1.7.1 Default behaviour

In WeOS interfaces are classified as *physical* or *virtual* interfaces:

⁴<http://www.oidview.com/oidview.html>. OidView is a trademark of BYTESPHERE TECHNOLOGIES LLC.

⁵<http://www.mg-soft.com/mgMibBrowserPE.html>.

⁶<http://www.castlerock.com/>. SNMPc is a trademark of Castlerock Computing.

- *Physical interfaces*: Physical interfaces are Ethernet ports, DSL ports, and link aggregates. As of WeOS v4.33.0, the default behaviour of the physical interfaces are as follows:
 - Ethernet and DSL ports: Ethernet/DSL ports have *fixed* allocation ifIndexes starting from 4096. Indexes are allocated in ascending order (4096, 4097, . . . , "4096+NB_OF_PORTS-1").
 - Link Aggregates: Link aggregates are assigned ifIndexes *dynamically*, starting from "4096+NB_OF_PORTS".
- *Virtual interfaces*: Examples of virtual interfaces are VLAN (layer-2) interfaces, and various types of network and tunnel interfaces (*vlan*, *ppp*, *gre*, *ssl*, etc.), as well as the loop-back interface (*lo*). As of WeOS v4.33.0, the default behaviour of the virtual interfaces are as follows:
 - Loopback interface: The loop-back interface is assigned ifindex "1" (fixed).
 - Other virtual interfaces: Other virtual interfaces are assigned ifIndexes *dynamically* within the range 2-4095 (random order). If an interface, e.g., "VLAN 2", is removed and later re-created, that interface will typically get a different ifIndex the second time.

6.1.7.2 Controlling ifIndex allocation

It is possible to modify the ifIndex allocation by changing the *start ifIndex* for *physical* and *virtual* interfaces. Below is an example where the ifIndex start for physical interfaces is set to "1" on a 10-port WeOS product.

 **Example**

```
example:/config/snmp/#> show ifindex-start
Physical 4096, Virtual 1
example:/config/snmp/#> ifindex-start physical 1
Virtual ifIndex was automatically adjusted to 19
example:/config/snmp/#> show ifindex-start
Physical 1, Virtual 19
example:/config/snmp/#>
```

In this example, the ifIndex start for virtual interfaces automatically adjusted to avoid overlap with the physical interfaces.

6.2 Managing SNMP via the web interface

Menu path: Configuration ⇒ SNMP

On the SNMP configuration page you will be presented to the current settings for SNMP on your switch, see below. You may change the settings by editing the page.

On the lower part of the page there is a list of SNMP v3 Users.

SNMP

Enabled

Read Community	public
Write Community	private
Trap Community	trap
Trap Host Address 1	192.168.2.13
Trap Host Address 2	
Trap Host Address 3	
ifIndex Start	Default ▾

Apply Cancel

Enabled	Check the box to enable SNMP. If you have a JavaScript enabled browser the other settings will not be displayed unless you check this box.
Read Community	A community identifier for read access. Leave blank to disable read community.
Write Community	A community identifier for read/write access. Leave blank to disable write community.
Trap Community	A community identifier for traps. Defaults to community identifier trap .

Continued on next page

Continued from previous page	
Trap Host Address 1/2/3	IP address or Domain name of SNMP trap management station. None, one , two or three addresses may be filled in. Leave all blank to disable SNMP traps.
ifIndex Start	The start values for ifIndex (Physical and virtual). Select override to change default values

6.2.1 Manage SNMP v3 Users

On the lower part of the SNMP configuration page you will be presented to the list of currently configured SNMP v3 users.

SNMP v3 users







Type	Name	Auth	Auth. Passphrase	Crypto	Crypto Passphrase	OID tree	
rwuser	snmpv3ro	SHA1	...			1.	 
rwuser	snmpv3rw	SHA1	...			1.	 

Figure 6.2: Listing of SNMP v3 users.

Type	Access rights for the user. rwuser User has read and write access. rouser User has read access only.
Name	A text string defining the user. Max 32 characters. Valid characters are ASCII 33-126 except '#' (ASCII 35).
Auth	Achieve message integrity protection by specifying MD5 or SHA1 message authentication.
Auth. Passphrase	The authentication password is a string of 8-16 characters. ASCII characters 33-126 except '#' (ASCII 35) are allowed.
Crypto	Achieve message privacy by specifying DES or AES128 message encryption.
Crypto Passphrase	The encryption password is a string of 8-16 characters. ASCII characters 33-126 except '#' (ASCII 35) are allowed.
OID Tree	Limit access to a certain branch of the supported MIB. Defaults to the whole tree ('1.')
 Edit	Click this icon to edit the SNMP v3 user in that table row.
 Delete	Click this icon to remove a the SNMP v3 user in that table row.
New User	Click on this button to create a new SNMP v3 user.

When clicking the *New User* button, the SNMP v3 user edit page will be displayed.

New SNMP v3 User

Type	<input type="text" value="rwuser"/>
Username	<input type="text" value="operator3"/>
Auth	<input type="text" value="SHA1"/>
Auth Passphrase	<input type="password" value="....."/> 
Crypto	<input type="text" value="AES128"/>
Crypto Passphrase	<input type="password" value="....."/> 
OID Tree	<input type="text" value="1.3.6.1.4.1"/>

Figure 6.3: New SNMP v3 user.

See table above for description of fields.

6.3 Manage SNMP Settings via the CLI

Command	Default	Section
<u>SNMP Server Configuration</u>		
[no] snmp-server	Enabled	Section 6.3.1
[no] rocommunity <COMMUNITY>	Public	Section 6.3.2
[no] rwcommunity <COMMUNITY>	Disabled	Section 6.3.3
[no] trapcommunity <COMMUNITY>	trap	Section 6.3.4
[no] host <IPADDR FQDN>	Disabled	Section 6.3.5
[no] ifindex-start [physical <VALUE>] [virtual <VALUE>]		Section 6.3.6
[no] rouser <USERNAME> [auth <md5 sha1> <PASSPHRASE> [crypto <des aes128> <PASSPHRASE>]] [OIDTREE]	Disabled	Section 6.3.7
[no] rwuser <USERNAME> [auth <md5 sha1> <PASSPHRASE> [crypto <des aes128> <PASSPHRASE>]] [OIDTREE]	Disabled	Section 6.3.8
<u>SNMP Server Status</u>		
show snmp-server		Section 6.3.9

6.3.1 Manage SNMP Server

Syntax [no] snmp-server

Context [Global Configuration](#) context.

Usage Enter SNMP Server Configuration context. If the SNMP server is disabled, it will be enabled when issuing the **"snmp-server"** command. Use **"no snmp-server"** to disable the SNMP server.

Use **"show snmp-server"** to show all SNMP server settings. (Also available as **"show"** command within the SNMP Server Configuration context.)

Default values Enabled.

6.3.2 Manage SNMP Read Community

Syntax [no] rocommunity <COMMUNITY_STRING>

Context [SNMP Server Configuration](#) context.

Usage Configure the SNMP Read Community string. Use **"no rocommunity"** to disable the SNMP Read Community.

Use **"show rocommunity"** to show the SNMP Read Community setting.

Default values Public

6.3.3 Manage SNMP Write Community

Syntax [no] rwcommunity <COMMUNITY_STRING>

Context [SNMP Server Configuration](#) context.

Usage Configure the SNMP Write Community string. Use **"no rwcommunity"** to disable the SNMP Read Community.

Use **"show rwcommunity"** to show the SNMP Write Community setting.

Default values Disabled.

6.3.4 Manage SNMP Trap Community

Syntax [no] trapcommunity <COMMUNITY_STRING>

Context [SNMP Server Configuration](#) context.

Usage Configure the SNMP Trap Community string. **"no trapcommunity"** will reset the trap community to the default string (**"trapcommunity trap"**).

Use **"show trapcommunity"** to show the SNMP Trap Community setting.

Default values trap

6.3.5 Manage SNMP Trap Hosts

Syntax [no] host <IPV4ADDRESS|FQDN>

Context [SNMP Server Configuration](#) context.

Usage Configure a SNMP Trap Host (IP address or Domain name). Up to three trap hosts can be configured (issue the **"trap-host"** command multiple

times with different addresses). Use **"no host <IPV4ADDRESS|FQDN>"** to remove a trap-host and **"no host"** to remove all trap hosts.

Without any defined trap host, SNMP traps will not be sent.

Use **"show host"** to show the configured SNMP Trap Hosts.

Default values Disabled.

6.3.6 Manage SNMP ifIndex-start

Syntax [no] ifindex-start [physical <VALUE>] [virtual <VALUE>]

Context [SNMP Server Configuration](#) context.

Usage Configures the ifIndex-start value used by the WeOS SNMP server. Use **"show ifindex-start"** to show current settings.

Default values Physical = 4096, Virtual = 1.

6.3.7 Manage SNMPv3 Read-Only User

Syntax [no] rouser <USERNAME> [auth <md5|sha1> <PASSPHRASE> [crypto <des|aes128> <PASSPHRASE>]] [OIDTREE]

Context [SNMP Server Configuration](#) context.

Usage Configure a SNMP read-only user.

- *USERNAME*: A text string defining the user. Max 32 characters. Valid characters are ASCII 33-126 except '#' (ASCII 35).
- *Authentication*: Achieve message integrity protection by specifying MD5 or SHA1 message authentication. The authentication password is a string of 8-16 characters. ASCII characters 33-126 except '#' (ASCII 35) are allowed.
- *Encryption*: Achieve message privacy by specifying DES or AES128 message encryption. The encryption password is a string of 8-16 characters. ASCII characters 33-126 except '#' (ASCII 35) are allowed.
- *OIDTREE*: Limit access to a certain branch of the supported MIB. Defaults to the whole tree ('1.')

Use **"no rouser <USERNAME>"** to remove a specific *read-only* user, or **"no rouser"** to remove all read-only users.

Use **"show rouser"** show settings for configured SNMPv3 read-only users.

Default values Disabled.

Examples

- Authentication and encryption:
"rouser alice auth sha1 alicepwd1 crypto aes128 alicepwd2"
- Authentication with access to dot1dBridge subtree:
"rouser bob auth md5 bobspwd1 1.3.6.1.2.1.17"

6.3.8 Manage SNMPv3 Read-Write User

Syntax [no] **rwuser** <USERNAME> [auth <md5|sha1> <PASSPHRASE> [crypto <des|aes128> <PASSPHRASE>]] [OIDTREE]

Context [SNMP Server Configuration](#) context.

Usage Configure a SNMP read-write user. For more information, see [section 6.3.7](#).

Use **"show rwuser"** show settings for configured SNMPv3 read-write users.

Default values Disabled.

Examples See [section 6.3.7](#).

6.3.9 Show SNMP server status

Syntax **show snmp-server**

Context [Admin Exec](#) context.

Usage Show whether SNMP server is running or not.

Examples

SNMP server enabled

Example

```
example:/#> show snmp-server  
SNMP server running as PID: 540  
example:/#>
```

SNMP server disabled (see "**no snmp-server**" in [section 6.3.1](#)).

 **Example**

```
example:/#> show snmp-server  
No SNMP server currently running  
example:/#>
```

Part II

Common Switch Services

Chapter 7

General Switch Maintenance

7.1 Overview

The table below summarises maintenance features available for the different management tools. General descriptions of these features are presented in [sections 7.1.1-7.1.10](#). If you are only interested in knowing how to manage maintenance features via the Web or CLI, please visit [sections 7.2](#) or [7.3](#) directly.

Feature	Web	CLI	General Description
<u>Firmware Upgrade</u>			
Upgrade primary firmware	X	X	Section 7.1.1
Upgrade backup firmware	X	X	-"-
Upgrade bootloader	X	X	-"-
View firmware versions	X	X	-"-
<u>Bootstrap Options</u>			
Manage Cable Factory Reset		X	Section 7.1.2.2
Configuration File Media		X	-"-
BOOTP Bootstrap Settings		X	-"-
USB Bootstrap Settings		X	-"-
<u>Login Account management</u>			
Set Admin Password	X	X	Section 9.1.1.1
Recover from lost Admin Password			Section 7.1.3
			Continued on next page

Continued from previous page			
Feature	Web	CLI	General Description
<u>Configuration Files and Reboot</u>			
Reset to Factory Default	X	X	Section 7.1.3
Reboot	X	X	Section 7.1.4
View Configuration Files	(X)	X	--
View Configuration Hash	X	X	Section 7.1.4.1
Alternate Configuration Files		X	Sections 7.1.4 and 7.1.5
Configuration Backup	X	X	Sections 7.1.4 and 7.1.5
Configuration Upload	X	X	Sections 7.1.4 and 7.1.5
Auto-Backup and Restore (USB)		X	Section 7.1.6
Configuration Deployment (USB)			Section 7.1.7
<u>Virtual File System</u>			
Maintenance of Configuration		X	Section 7.1.5
Log and USB files	(X)	X	--
<u>Certificate and Key Management</u>			
Upload PKCS#12 Bundle	X	X	Section 7.1.8
Upload PEM file	X	X	--
Public Certificate	X	X	--
Private Key	X	X	--
CA Certificate	X	X	--
Upload OpenVPN static key file	X	X	--
Set (non-default) Label	X		--
<u>Protocol License Management</u>			
Upload License file	X	X	Section 7.1.9
<u>Maintenance and diagnostic tools</u>			
Ping	X	X	Section 7.1.10
Traceroute	X	X	--
IPConfig Client	X	X	--
Wake-On-LAN	X	X	--
SSH Client/Server		X	
SSH Host Keys (Server)	X	X	
Continued on next page			

Continued from previous page			
Feature	Web	CLI	General Description
SSH User Keys (Server)		X	
Telnet Client/Server		X	
Tech Support	X		
<u>Other maintenance features</u>			
Show System Environment Sensors	X	X	
Show System Uptime	X	X	
Show Memory Usage	X	X	
Show Running Processes		X	
Show Flash Table		X	

7.1.1 WeOS Firmware

A WeOS unit holds two types of firmware:

- *System firmware*: The *system firmware* holds the operating system, which is what we usually refers to when we say WeOS. For robustness purposes, a WeOS unit typically holds two separate system firmware images.
 - *Primary* firmware image: The primary firmware image (or primary image) contains the system firmware loaded by default by the bootloader.
 - *Backup* firmware image: The backup firmware image (also known as backup image or secondary image) contains the system firmware image loaded in case an error is encountered while loading the primary image.



Hint

It is strongly recommended to use the same system firmware *version* for the primary and backup image to ensure that the backup and primary firmwares interpret the configuration the same way.

For information on how to keep the primary and backup firmware synchronised, see [section 7.1.1.2](#).

- *Bootloader*: The *bootloader firmware* (or simply "bootloader") is the basic firmware run to bootstrap the system. The *bootloader* will in turn load the system firmware (trying the *primary* image first).

It is possible to upgrade both the system firmware (primary and secondary image) and the bootloader firmware.



Warning

There is no general guarantee that an older *system firmware* can be loaded into the switch, i.e., *downgrade* is not generally guaranteed to work. However, if the firmware is downgraded for example from version 4.16.0 to 4.15.1, it is recommended to reboot the switch once the old firmware has been installed. When the switch comes up with the old firmware (here 4.15.1), copy the *factory default configuration* to the *running configuration*. See [section 7.1.4](#) for more information on configuration files.

7.1.1.1.1 Upgrading firmware and bootloader

WeOS firmware and bootloader can be downloaded from www.westermo.com.

The method to upgrade firmware and bootloader differs somewhat if the unit to upgrade is running WeOS 4.13.1 (or later), as compared to units running releases before 4.13.1.

- *Units running WeOS 4.13.1 or later:* The WeOS firmware and bootloader can be upgraded using a common "pkg" file in WeOS 4.13.1 and later. This is explained further in [section 7.1.1.1.2](#).

Note

WeOS releases older than 4.13.1 (e.g., WeOS 4.13.0 or 4.11.2) are unable to handle "pkg" files.

- *Units running releases earlier than WeOS 4.13.1:* When upgrading WeOS units running older versions than WeOS 4.13.1 (e.g., WeOS 4.13.0 or 4.11.2), there are individual firmware and bootloader files per WeOS product. This is described in [section 7.1.1.1.1](#).

Hint

If your unit is running, e.g., WeOS4.12.0, and you wish to upgrade using a "pkg" installation file (e.g., "WeOS-4.14.0.pkg") you first need to upgrade to WeOS 4.13.1 using the old method in [section 7.1.1.1.1](#).

Hint

If the switch reports lack of free memory when trying to upgrade the firmware, try to disable non-essential services on the switch.

7.1.1.1.1.1 Upgrading when running older firmware than WeOS 4.13.1

Before WeOS 4.13.1 the firmware installation file to use differed per product family. Similarly, there were different bootloader installation files per product. A summary of name conventions is given in the table below:

Product	Primary and secondary FW	Bootloader FW
Lynx and Viper	lwXXXX.img (e.g., lw4112.img)	imx27-redboot-ZZZ.bin (e.g., imx27-redboot-4.11.bin)
Wolverine	wwXXXX.img (e.g., ww4112.img)	" "
Falcon	fwXXXX.img (e.g., fw4112.img)	" "

If you run a release older than 4.13.1, and wish to upgrade to 4.14.0 or later, where only "pkg" files are supported, you must first upgrade to 4.13.1 (or some later 4.13.x release) using "img" files¹.



Hint

Although any 4.13.x release from 4.13.1 and later can be used as intermediate release when upgrading to pkg files, it is recommended that you use the most recent 4.13.x release. See www.westermo.com for download of WeOS 4.13 releases.

Below there are examples showing how to upgrade the primary firmware to a WeOS 4.13 release with support for "pkg" files (here "4.13.4" is used) and bootloader via a FTP server (or TFTP server) at 192.168.3.10 on a WeOS Lynx unit.

- Upgrading primary firmware via CLI on a Lynx (before WeOS 4.13.1). Here we upgrade to WeOS 4.13.4 from a FTP server at 192.168.3.10.



Example

```
example: /#> upgrade primary 192.168.3.10 lw4134.img ...
```

- Upgrading bootloader via CLI on a Lynx (before WeOS 4.13.1). Here we upgrade the bootloader to "imx27-redboot-4.11.bin" from a FTP server at 192.168.3.10.

¹WeOS 4.13.1 and later 4.13.x releases are available both as "img" and "pkg" files, while only "pkg" files are available from WeOS 4.14.0 and onward.

Example

```
example: /#> upgrade boot 192.168.3.10 imx27-redboot-4.11.bin ...
```

7.1.1.1.2 Upgrading when running WeOS 4.13.1 (or later) If you have WeOS 4.13.1 or later installed, upgrading firmware or bootloader is simplified in the sense that the same installation file (a "pkg" file) is used for all types of upgrades (bootfile or firmware) on any type of WeOS product. The table below lists the firmware used upgrade system firmware and bootloader.

Product Family	System Firmware (Primary/Secondary Image)	Bootloader Firmware
All WeOS products	WeOS-X.X.X.pkg (e.g., WeOS-4.33.0.pkg)	WeOS-X.X.X.pkg (e.g., WeOS-4.33.0.pkg)

Thus, upgrading the primary (or secondary) system firmware image, or the bootloader will be done using the same (pkg) installation file.

Note

If you use TFTP for upgrading with "pkg" files, make sure your TFTP server supports large files as defined in RFC2347[32].

Be aware that upgrade using TFTP may be much slower compared to the FTP or HTTP methods. This is of particular concern if the link you are transferring data through has high latency. Some examples are: ADSL/VDSL/SHDSL links, 3G/4G links or accessing via VPN tunnel.

This is an effect of how the TFTP protocol works. Every data block that is sent is ACKed by the other end, and the sender will wait for this ACK before sending the next piece of data. FTP and HTTP use TCP for transfer, and TCP has its sliding window algorithm that is much better suited for high latency scenarios.

Example

An example calculation of approximate transfer time for a high latency link: Let's say the data is 50 Mbyte (PKG files are often larger than this) and the latency, or round-trip-delay, is: 50 ms. The standard TFTP block size is 512 bytes.

50 Mbyte divided in 512 byte sized blocks means 102400 blocks.
This translates to 5120 seconds at 50 ms per block (1 hour and 25 minutes).

Below you find examples of upgrading *firmware* and *bootloader* using "pkg" files:

- *Upgrading firmware* via CLI: Here we upgrade the primary firmware to 'WeOS 4.33.0 from a FTP server (or TFTP server) at 192.168.3.10.:



Example

```
example: /#> upgrade primary 192.168.3.10 WeOS-4.33.0.pkg
...
```

- *Upgrading bootloader* via CLI: Here we upgrade to the bootloader from a FTP server (or TFTP server) at 192.168.3.10.):



Example

```
example: /#> upgrade boot 192.168.3.10 WeOS-4.33.0.pkg
...
```



Note

If your unit has an older version than WeOS 4.13.1 (e.g., WeOS 4.12.1), you are not able to upgrade using WeOS "pkg" installation files directly. You first need to upgrade to WeOS 4.13.1 (or a later 4.13.x release) using the methods described in [section 7.1.1.1.1](#).

7.1.1.2 Keeping Primary and Backup Firmware Synchronised

It is recommended to use the same version for primary and backup firmware. This ensures that your unit will have same functionality if it boots on the backup firmware as on the primary firmware.

Therefore, when upgrading the primary firmware, you are recommended to upgrade the backup firmware too. This section includes a 4-step example, where it is assumed you wish to upgrade the primary firmware on a WeOS unit from WeOS 4.13.4 to WeOS 4.14.1, i.e., from image "**WeOS-4.13.4.pkg**"² to "**WeOS-4.14.1.pkg**".

²WeOS 4.13.1 and later 4.13.x releases are available both in "pkg" and "img" format.

1. *Prepare:* (This step is not necessary if you did [steps 3 and 4](#) during an earlier upgrade, or if you have never upgraded your unit.)

Before upgrading the primary firmware, check that the backup firmware is of the same version as the primary (here WeOS 4.13.4), and that the startup configuration file is matching the firmware version.

- (a) *Startup Configuration file matching current firmware version (here WeOS 4.13.4):* The simplest way to ensure that your startup configuration file is in-line with the current firmware version is to click an **Apply** "button" in the Web (e.g., **Apply** in the IGMP configuration page, see [section 21.3](#)), or to run "**copy running-config startup-config**" in the CLI (see [section 7.3.26](#)).



Note

From WeOS 4.15.0 and onward, this step is no longer necessary, as the startup configuration will then automatically be updated in-line with the current firmware version. See also [section 7.1.4](#).

- (b) *Verify that version of backup image is the same as the primary firmware:* To find out what firmware version you are using, see *Detailed System Overview* page in the Web (see [section 4.4.2](#)) or use the "**show system-information**" in the CLI (see [section 7.3.2](#)). In the example below the primary firmware version is 4.13.4 and the backup is 4.9.2.



Example

```
example: /#> show system-information
```

```
System Information
```

```
=====
System Name       : example
System Contact    :
System Location   :
System Timezone   : Etc/UTC

Product Family    : Lynx           Model           : L210
Architecture      : mxc           Base MAC Address : 00:07:7c:10:de:80
Article number    : 3643-0105-007  Serial Number    : 16975
Boot loader ver.  : 4.11           Active firmware  : Main
Main firmware ver.: 4.13.4         Backup firmware ver: 4.9.2
... (More info follows)
```

If the backup image is of a different version (as in the example above), you should upgrade the backup firmware (to WeOS 4.13.4) before moving to [step 2](#). To upgrade the backup firmware (to WeOS 4.13.4), either use the Web upgrade facility, see [section 7.2.1](#), or use the CLI **"upgrade"** command, see [section 7.3.1](#). The example below shows an upgrade of the backup firmware from a FTP/TFTP server at 192.168.3.10.

```

Example
example:/#> upgrade secondary 192.168.3.10 WeOS-4.13.4.pkg

==> Upgrade in progress, console disabled. Please stand by ... <==

Connecting to 192.168.3.10:21 (192.168.3.10:21)
WeOS-4.13.4.pkg      100% |*****| 57747k  0:00:00 ETA

Checking download ...
Unpacking weos (from /upgrade/download)...
Setting up weos (4.13.4-1)...

Checking lw4134.img ...
  Type: CramFS
  ID: OK (Lnx2)
  Size: OK
  CRC: OK 0xDC73D8CD

Flashing /dev/mtd2 ...
100% - [=====]

Updating RedBoot directory with new CRC ...
100% [=====]

Done.
example:/#>

```

2. *Upgrade primary*: To upgrade the primary firmware to WeOS 4.14.1, either use the Web upgrade facility (see [section 7.2.1](#)), or use the CLI **"upgrade"** command from the CLI (see [section 7.3.1](#)). E.g., use **"upgrade primary 192.168.3.10 WeOS-4.14.1.pkg"** to upgrade the primary firmware from a FTP/TFTP server at 192.168.3.10. Compare with the example in [step 1b](#).

Note
As you are running your unit on a primary firmware, upgrading the primary firmware implies that the unit will automatically be rebooted when the upgrade finishes.

3. *Login and confirm configuration*: At the end of the upgrade process, the unit will reboot, using the new primary image if the upgrade procedure succeeded. After logging in again, do the following steps:

- (a) *Verify configuration*: Verify that the unit works as expected, doing whatever tests you find necessary for your use case. If the unit does not work as expected, you should either consider downgrading to the previous version (here WeOS 4.13.4) or to inspect the running configuration to find and correct the cause of your problems.

**Note**

If you decide to downgrade, it is recommended to do that *before* changing or saving startup configuration for the new version (WeOS 4.14.1), as there are no general guarantees that the older WeOS version can interpret a later configuration file in exact the same way.

- (b) *Make Startup Configuration file match the new firmware version (here WeOS 4.14.1)*: (This is similar to [step 1a](#), but now for the new firmware.) If the unit works as expected, store the configuration in-line with the new firmware (WeOS 4.14.1). The simplest way is to click an **Apply** "button" in the Web (e.g., **Apply** in the IGMP configuration page, see [section 21.3](#)), or to run "**copy running-config startup-config**" in the CLI (see [section 7.3.26](#)).

**Note**

From WeOS 4.15.0 and onward, this step is no longer necessary, as the startup configuration will then automatically be updated in-line with the current firmware version. See also [section 7.1.4](#).

4. *Upgrade backup firmware*: The last step is to upgrade the backup firmware to the new WeOS version (here 4.14.1). For this you can use the Web upgrade facility, see [section 7.2.1](#), or the CLI "**upgrade**" command, e.g., "**upgrade secondary 192.168.3.10 WeOS-4.14.1.pkg**" to upgrade the secondary firmware from a FTP/TFTP server at 192.168.3.10. Compare with the example in [step 1b](#).

7.1.2 System bootstrap

During system bootstrap, the *bootloader* firmware is responsible for loading the *system* firmware. This is described further in [section 7.1.2.1](#).

As part of the bootstrap, the WeOS unit is also capable of conducting a *cable factory reset* ([section 7.1.3.3](#)). The configuration is typically read from flash (startup-configuration file), but it is possible to retrieve the configuration from USB ([section 7.1.6-7.1.7](#)), or via BOOTP. Options for controlling these and other bootstrap related settings is covered in [section 7.1.2.2](#).

7.1.2.1 Loading System Firmware (WeOS)

The bootloader attempts to load the *primary* system firmware image, with fall-back to loading the secondary system firmware if failing to load the primary firmware.

As described further below, different WeOS products use different bootloaders (Barebox, U-boot or RedBoot). Barebox is the preferred bootloader on all products, and is described in more detail here.

The Barebox bootloader enables you to stop the bootstrap process (from console port, press *Ctrl-C* at system startup), and enter an interactive *boot-menu*.

Example

```
Barebox Boot Menu
1: Primary Partition
2: Secondary Partition
3: Network (BOOTP)
4: Factory Reset
5: System Recovery
6: Shell
```

Access to the Barebox boot-menu can be password protected ([section 7.1.2.2](#)). From the boot-menu you can select which system firmware image (WeOS) to load (primary or secondary image on flash), but you can also choose to download a firmware remotely via TFTP into RAM, by entering the *rescue-mode* (System Recovery).

**Note**

As of WeOS v4.33.0, use of BOOTP in the Barebox boot-menu (alternative "3.") is a *technology preview*. Use of TFTP (rescue mode) or BOOTP is limited to Ethernet ports with "internal PHY"; SFP ports can for example not be used.

**Warning**

Do not enter the bootloader shell (alternative "6.") unless you know what you are doing. Use of the bootloader shell is unsupported and can result in a broken unit.

If Barebox fails to load both the primary and secondary firmware, it will automatically enter the rescue-mode, providing the same facilities as when entering rescue-mode via the regular boot-menu (alternative "5: System Recovery"). That is, you can access the switch via the console port and download a new firmware into RAM via TFTP. Once the unit has booted, you can login and conduct a regular firmware upgrade (storing the firmware to flash).

In rescue-mode, Barebox also provides a rescue console service (UDP network console), which is useful if you do not have access to a console cable, or if your WeOS product lacks a console port. The rescue console can be accessed using any tool that can open a UDP socket, e.g., *netcat* on a Unix system `"nc -u -p 6000 192.168.2.200 6000"` if the default IP and UDP port numbers are used; this assumes your PC has IP address 192.168.2.1. [Section 7.1.2.2](#) gives more information on configuration options related to the rescue console.

WeOS units run different types of bootloaders (Barebox, U-boot or RedBoot), and the boot-menu and rescue-mode features described above only apply to Barebox. The following bootloaders are used by different WeOS product platforms.

- Basis: Products based on the Basis platform use the *Barebox* or *RedBoot* bootloader. *Barebox* is supported from WeOS 4.23.x, and is now the *preferred* bootloader for Basis products.
- Corazon: Products based on the Corazon platform use the *Barebox* or *U-boot* bootloader. *Barebox* is supported from WeOS 4.15.2, and is now the *preferred* bootloader for Corazon products.
- Coronet: Products based on the Coronet platform use the *Barebox* bootloader.

For information about what platform your product has, see [section 4.4.2](#) (Web), or [section 7.3.2](#) (CLI), or see the product list in [section 1.5](#).

If you wish to check what type of bootloader (Barebox, U-boot or RedBoot) your unit runs, use the "**show partitions**" command as described in [section 7.3.49](#).

See [section 7.1.1.1](#) for information on how to upgrade your bootloader.

7.1.2.2 Bootstrap options

- *Enable/disable cable factory reset:* As part of the bootstrap, the WeOS unit is capable of conducting a *cable factory reset* as described in [section 7.1.3.3](#). Cable factory reset is by default *enabled*.

Disabling cable factory reset speeds up the boot and, for some installations, reduces the risk of inadvertently triggering a factory reset on devices where only one looped cable is required to perform factory reset.

Example

```
example:/#> boot
example:/boot/#> no cable-reset
example:/boot/#> show cable-reset
Disabled
example:/boot/#> end
example:/#>
```

Warning

When cable factory reset is disabled, the console port remains the last means to perform a factory reset.

- *Configuration Boot Media:* WeOS supports two methods to retrieve configuration file(s): from the on-board flash (default), from TFTP server (by use of BOOTP), and there are also options to deploy or restore configuration from a USB stick.
 - *Flash:* By default the WeOS unit boots using configuration files (startup-configuration, VPN certificates, etc.) from the (on-board) flash. The configuration on flash is also used as fall-back when other methods fail.
 - *BOOTP:* It is possible to bootstrap the configuration using BOOTP. For this you need a DHCP/BOOTP Server ([section 23](#)), and a TFTP Server,

holding the unit's configuration file. As of WeOS v4.33.0, it is only possible to use BOOTP/TFTP to download the WeOS configuration file (certificates for IPsec, etc., can not be downloaded).



Note

Bootstrapping the configuration file using BOOTP is only possible over the WeOS unit's Ethernet ports. DSL ports (SHDSL, ADSL, VDSL) can not be used.

- *USB*: It is possible to retrieve the configuration from a USB stick³ by utilising WeOS USB Auto-Backup & Restore ([section 7.1.6](#)) or WeOS USB Deployment ([section 7.1.6](#)) functions⁴. These services have precedence over bootstrapping from Flash and BOOTP, but can be disabled (see [USB Bootstrap Settings](#) below).
- *BOOTP Bootstrap Settings*: When using BOOTP as configuration boot media, you can specify the BOOTP timeout (default 5 minutes), i.e., the maximum time to wait for the BOOTP/TFTP configuration file download to succeed. Fall-back is to use configuration on on-board flash.

By default, the downloaded configuration file is only stored in RAM. You can manually store it to flash (e.g., by "**cp running-config startup-config**"), but you can also configure the WeOS to store the file to *startup-config* on flash automatically after download.

- *USB Bootstrap Settings*: During bootstrap, a WeOS unit checks if there is a USB stick attached in order to *restore* [section 7.1.6](#)) or *deploy* ([section 7.1.6](#)) a configuration from the USB stick.
 - *Timings*: There are two timings related to Bootstrap and USB services:
 - * *Delayed USB backup/restore and USB deploy*: (Non-configurable) A USB media not plugged in (or detected) when the device boots up can still be used to backup/restore or deploy the device configuration up to 30 seconds after power on.
 - * *USB bootstrap timeout*: (Configurable) The USB bootstrap timeout halts boot for specified number of seconds, waiting for USB media

³See [section 1.5.1](#) for WeOS products with USB interfaces, and [section 7.1.5.1](#) for list of USB sticks verified for use with WeOS.

⁴As a technology preview feature, there is also a boot media option referred to as "boot from USB". See WeOS release notes for more information on WeOS technology previews in general and for specific information on the "boot from USB" function.

to settle and be detected by the device. Before the timeout has elapsed and no media has been detected the device is unreachable with all ports remaining in blocking. Default: **Disabled** (i.e., zero delay)



Hint

Setting a "USB bootstrap timeout" is useful to avoid a situation where the unit first applies the configuration from on-board flash, and afterwards detects the USB stick and applies USB *restore* or *deploy* ("Delayed USB backup/restore and USB deploy").

- *Enable/Disable*: USB bootstrap services can be disabled. Disabling USB bootstrap services implies disabling USB Deployment and *automatic* USB Backup & Restore features. Manual backup and restore to/from a USB stick is still possible. Default: **Enabled**



Warning

USB bootstrap services are enabled by default for ease of use and robustness. However, it gives users with physical access to the switch the opportunity to modify or retrieve the configuration without logging in. If unauthorised personnel have physical access to the unit it is *recommended* to disable USB bootstrap services for security purposes.

Below is an example of how to disable USB Bootstrap services.



Example

```
example:/#> boot
example:/boot/#> usb
example:/boot/usb/#> no enable
example:/boot/usb/#> show
  Status      : Disabled
  Timeout     : Disabled
example:/boot/usb/#> leave
example:/#>
```

- *Barebox boot-menu options*: Boot options related to the Barebox boot-menu (boot-menu password, rescue console settings, etc.) are described in [sections 7.3.16-7.3.21](#).

7.1.3 What to do if you cannot access your switch

Occasionally you may end up in a situation where you cannot access your switch:

- *Forgetting IP address*: If you have forgotten what IP address you assigned to your switch, you will no longer be able to access it remotely (Web, SSH, Telnet, SNMP). [Section 7.1.3.1](#) presents different methods to find the IP address of your switch.
- *Forgetting password*: If you have forgotten the **admin** password you assigned to your switch, you should conduct either a *factory reset* or a *password reset*. Both alternatives require that you have *physical access* to the switch.
 - *Factory Reset*: By resetting to factory defaults, the switch configuration (including the **"admin"** password) will be reset⁵. I.e., the **"admin"** password is restored to **"westermo"**, enabling you to login again.

The way to accomplish a factory reset may differ if the switch has a console port ([section 7.1.3.2](#)) or if it lacks a console port ([section 7.1.3.3](#)).
 - *Password Reset*: On switches with a console port there is a possibility to reset the **"admin"** password to its default value (**"westermo"**) without affecting the rest of the configuration, see [section 7.1.3.2](#).
- *Misconfiguration*: You may also lose the ability to access your switch remotely (Web, SSH, Telnet, SNMP, WeConfig) due to *misconfiguration*, e.g., by disabling all Ethernet ports, or moving them to a VLAN where the switch has no IP address assigned. This case can be resolved by logging into the switch via the console port, and change the configuration appropriately via the CLI (see [chapter 5](#) on information of how to access the CLI via the console port).

However, if the switch does not have a console port, you may need to conduct a *factory reset* as described in [section 7.1.3.3](#).

7.1.3.1 Discovering the IP address of your switch

The factory default IP setting enables access to the switch via IP address 192.168.2.200, as well as via an address assigned via a DHCP server⁶ (see [table 7.4](#)).

⁵Only files on built-in flash are affected. Files on any attached USB stick are not affected.

⁶In addition, the unit will autoconfigure itself with a *link-local* address in the 169.254.x.x range, where 'x' is in interval 0-255. See [section 22.2.6](#) for more information.

	Address	Netmask	Gateway
Primary IP address	Dynamic (DHCP)	(Dynamic)	(Dynamic)
Secondary IP address	192.168.2.200	255.255.255.0	Disabled

Table 7.4: Factory Default IP settings.

There are several ways to discover the IP address of a product:

1. *WeConfig (from PC)*: The WeConfig tool is designed to scan for (Westermo) switches on the local network. See the WeConfig User Guide[68] for details on how to use the WeConfig tool. This option is probably the simplest method to find the IP address of a switch, but will not work if the IPConfig service has been disabled on your switch (see [section 8.3.31](#) for information on how to enable/disable IPConfig on your switch).
2. *IPConfig client (from switch)*: The WeOS CLI and the Web contain an IPConfig *client* scanning facility, thus if you are logged into a switch you are to scan for neighbour switches. As in the previous step, switches can only be discovered this way if they have the IPConfig *service* enabled.
3. *Via console port*: On switches equipped with a console port, the IP address of the switch can be found using the switch Command Line Interface (CLI). See [chapter 5](#) for more information of how to use the CLI. (If you have forgotten the **admin** password, please see [section 7.1.3.2](#)).
4. *LLDP*: When LLDP is enabled ([section 8.1.1](#)), WeOS announces itself (IP address) in LLDP messages. Thus, an LLDP client (or a network sniffer such as Wireshark⁷) can be used to discover the IP address of the switch.

In case you are not able to discover the IP address by any of these methods, conducting a factory reset will take the switch back to its original IP configuration (as shown in [table 7.4](#)). See [sections 7.1.3.2](#) and [7.1.3.3](#) for information on how to conduct a factory reset.

7.1.3.2 Password or Factory Reset via Console Port

For WeOS switches *equipped with a console port*, it is possible to conduct a *factory reset* or just a *password reset* using the special accounts (**factory** or **password**). For security reasons, these special accounts can *only be used via the console port*. For security hardening purposes, these two special accounts can be disabled in the device's boot context, in the CLI (see [sections 7.3.11](#) and [7.3.12](#)).

⁷Wireshark network protocol analyser, <http://www.wireshark.org>.

- Admin password reset: It is possible to recover from a lost **admin** password by using the following login and password from the console port. The **admin** password will be reset to its default value (**westermo**), and thereby enable you to login to the switch again.
 - Login: **password**
 - Password: **reset**
- Factory reset: It is possible to reset the switch to factory defaults with the following login and password from the console port. The switch configuration (including the "**admin**" password) will be reset⁸.
 - Login: **factory**
 - Password: **reset**

7.1.3.3 Factory Reset without using Console Port

There is a mechanism to conduct a factory reset without using the console port or being logged into the unit – this method is referred to as "cable factory reset". The cable factory reset mechanism can be disabled as a bootstrap option, see [section 7.1.2.2](#).



Note

Depending on the type of product, cable factory reset is conducted by connecting *one pair* of Ethernet ports (single cable) **or** *two pairs* of Ethernet ports (two cables) as shown in the table below.

On products where a single cable is used to perform the reset, with ports that are otherwise used for FRNT or RSTP, it is recommended to disable cable factory reset in the bootstrap options.

1. Power off the switch and disconnect *all* Ethernet cables (including copper and fiber cables) and DSL cables.
2. Connect one pair (or two pairs) of Ethernet ports as described in the table below. The ports need to be connected directly, i.e., **not** via a hub or switch. Use a *straight* cable - not *cross-over* cable - when connecting a port pair.

⁸Only files on built-in flash are affected. Files on any attached USB stick are not affected.

Product/Model	Ethernet Port Pair 1	Ethernet Port Pair 2
Falcon FDV-206-1D1S	port 1 ↔ port 4	port 2 ↔ port 3
Lynx L106/206-F2G L110/210	port 3 ↔ port 6 port 3 ↔ port 10	port 4 ↔ port 5 port 6 ↔ port 7
Lynx-DSS L105/205-S1 L106/206-S2 L108/208-F2G-S2	port 1 ↔ port 4 port 1 ↔ port 4 port 3 ↔ port 6	port 2 ↔ port 3 port 2 ↔ port 3 port 4 ↔ port 5
RedFox Industrial All RFI models	port 1/1 ↔ port 1/2	Not applicable
RedFox Industrial Rack All RFIR models	port 1 ↔ port 2	Not applicable
RedFox Rail RFR-212-FB	port X1 ↔ port X6	port X2 ↔ port X5
Viper All Viper-20A models All Viper-12A models All Viper-12 models	port X9 ↔ port X16 port X5 ↔ port X10 port X1 ↔ port X6	port X10 ↔ port X15 port X6 ↔ port X9 port X2 ↔ port X5
Wolverine DDW-x42 DDW-x42-485 DDW-225/226	port 1 ↔ port 2 port 1 ↔ port 2 port 2/1 ↔ port 2/4	Not applicable Not applicable port 2/2 ↔ port 2/3

3. Power on the unit.
4. Wait for the unit to start up. Verify that the ON LED is *flashing red*. This flashing indicates *ready to reset*. You can now go ahead with the factory reset, or abort the procedure.
 - *Go ahead with factory reset:* Acknowledge the factory reset by unplugging (one of) the cable(s). The ON LED stops flashing.
This initiates the factory reset process, and after a short while, the unit will restart with factory default settings.
 - *Abort the factory reset:* Simply wait for the procedure to time out, do not remove any of the cables. This takes approximately 30 seconds after the ON LED started flashing RED. The switch will conduct a normal

boot with the current startup config.

7.1.4 Configuration Files and Reboot

The system keeps three special configuration files:

- *Startup Configuration*: The configuration file used by the switch after system boot or reboot. The *startup configuration* is stored in non-volatile memory (flash)⁹.



Note

From WeOS 4.15.0 and onward, the startup configuration is verified to be in-line with the syntax of the current firmware version upon system boot. If there are deviations (which may be the case after a firmware upgrade), the startup configuration is automatically updated.

- *Running Configuration*: The configuration currently used by the switch. The running configuration is kept in volatile memory (RAM).

The *running configuration* is identical to the *startup configuration* when using the Web interface, the WeConfig tool or SNMP. That is, when using these methods to manage the switch, a change in the *running configuration* is immediately stored in the *startup configuration*.

In contrast, when managing the switch via the CLI, configuration changes only affect the *running configuration*. Thus, to survive a reboot, the running configuration must be copied to the startup configuration.

- *Factory Default Configuration*: The system always has a factory default configuration. It is kept in non-volatile memory (flash) and cannot be overwritten. At first boot, as well as after a factory reset, the startup configuration file is identical to the factory default configuration file.

In addition to these configuration files, it is possible (via CLI) to keep a set of additional configuration files on the switch, which enables easy swapping between alternate configurations.

⁹As described in [section 7.1.5](#), it is possible to keep several configuration files on flash. The startup configuration file is actually a symbolic name for one of the stored configuration files.

**Warning**

Configuring the switch via multiple management interfaces in parallel is discouraged, since it may lead to unexpected behaviour.

For example, consider the case when two users are accessing the switch at the same time, one user via the CLI and another user via the Web interface:

Assume the "CLI user" makes changes to the running configuration, but of some reason do not wish to copy these changes to the startup configuration (yet).

If the *another* user, the "Web user", applies a single change using the web management tool, all the changes done to the running configuration (by the "CLI user") will be saved to the startup configuration. (Actually clicking the **Apply** button, even without changing any values has the same affect.)

7.1.4.1 Configuration hash

To enable simple verification of configuration integrity, SHA-1 hashes are calculated for the *running configuration* and the *startup configuration*. These hashes can be obtained via web (section 4.4.2), CLI (section 7.3.32) or SNMP (WeOS private MIB).

The purpose of these hashes is that you should be able to verify that the configuration on your unit is unchanged. The intended procedure:

- Configure your unit as intended.
- Read out the hash(es) via SNMP (or Web/CLI), and store in your management PC.
- Regularly read out the hash(es) from your management PC and compare with the stored value.

**Note**

These hashes cover WeOS configuration only. They do not bootstrap options (section 7.1.2.2), certificates (section 7.1.8) or licenses (section 7.1.9).

The configuration file holds two initial comment lines with device specific information (serial number, etc.). These lines are not covered by the hash computation. Thus, if you replace a unit, the computed hash should be identical, assuming the units are of the same type and run the same WeOS version.

7.1.4.2 Account password when loading a configuration file

Configuration files contain information on user account and (ked) passwords, e.g., for the **"admin"** account. Thus, when loading a configuration file to the switch (i.e., overwriting the *startup-configuration* or *running-configuration*), the account passwords will also be replaced according to the setting in the new configuration file.



Warning

To copy a new configuration file to the *running-config* or *startup-config* while keeping the existing user names and passwords, the lines in the new configuration file containing the **"username"** command should be removed before installing the new configuration file.

If you unintentionally happen to lose the *admin* password because you copied a configuration file including an unknown **admin** password, see [section 7.1.3](#) for information on how to regain access to the switch.

7.1.5 Virtual File System

WeOS keeps various files of interest for the operator:

- Configuration files: By default there is only one configuration file (named *config0.cfg*) stored on the switch. However, it is possible to create and keep multiple configuration files on the switch, both for backup purposes or for easy shifting between configuration setups. Configuration files are commonly named with the prefix *config* and will always have *.cfg* as extension.

As mentioned in [section 7.1.4](#) there are also three special configuration files:

- *Running Configuration*: The running configuration is only stored in RAM, thus, it is not kept over a reboot.
 - *Startup Configuration*: The startup config is *mapped* to one of the stored configurations. By default it points to *config0.cfg*, but the mapping can be changed (using the CLI **"copy"** command as described in [section 7.3.26](#)).
 - *Factory Default Configuration*: The factory default configuration file cannot be modified (except through a firmware upgrade). It is available for the purpose of conducting a factory reset.
- Log files: Events are logged in various log files, e.g.:

- auth.log
- kern.log
- messages
- mgmt.log
- snmpd
- ppp.log

For units equipped with a USB port, the operator is also able to access files on a mounted USB stick.

The files are organised in a virtual file system, and are made available both for local and remote access.

	Local File Path	Remote File Path
Configuration files	cfg://	/cfg/
Log files	log://	/log/
USB files	usb://	/usb/

[Section 7.1.5.1](#) gives general information on the use of USB memory sticks in WeOS products. [Section 7.1.5.2](#) describes available methods for file maintenance when logged into the switch, while [section 7.1.5.3](#) covers methods available for maintaining files remotely.

7.1.5.1 General information on using USB memory sticks

In order to copy files to/from a USB memory stick attached to USB port of the WeOS product¹⁰, the USB memory stick *must*:

- be partitioned with at least one partition of at least 4MiB
- be formatted as EXT3, VFAT or FAT on the first partition

As of WeOS v4.33.0 the following USB stick(s) are verified for use with WeOS products:

Westermo USB stick 3641-0190 (Serial number 1195 or higher) for RedFox Rail and Viper, see user guides in [section 1.5](#).

¹⁰For information on WeOS products equipped with a USB port, see [section 1.5.1](#), or the User Guide of your WeOS product (see [section 1.5](#)).

If a factory reset is conducted on the WeOS unit, only files on unit flash (configuration, IPsec certificates, etc.) will be affected by the factory reset. Files on an attached USB stick (if present) will not be affected.

7.1.5.2 File access when logged into the switch

An operator logged in to a switch can copy, download or upload files using the CLI **"copy"** command. Services available when logged into the system include:

- Making local backup copies of files, e.g.,
"copy log://messages log://messages.5"
- Upload or download to/from a remote server via TFTP, FTP, and SCP. (Downloading is also available via HTTP.)

Upload example using TFTP:

```
"copy cfg://config0.cfg  
tftp://server.example.com/myswitchconfig.txt"
```

- Copying between systems: The CLI *copy* command can be used to copy files between remote systems via TFTP, FTP, SCP, and HTTP (HTTP can only be used as source, not destination).

Example copying from HTTP server to TFTP server:

```
"copy http://server1.example.com/original.txt  
tftp://server2.example.com/backup.txt"
```

7.1.5.3 Remote file access

An operator is able to upload and download files to/from the switch remotely via *SCP*. This feature is convenient and saves time, since files can be maintained without the need to log into each switch.

Example with remote file upload:

Example

```
unix> scp config1.cfg admin@myswitch.example.com:/cfg/  
Password for admin@myswitch.example.com:  
unix>
```

Example with remote file download:

Example

```
unix> scp admin@myswitch.example.com:/log/messages .  
Password for admin@myswitch.example.com:  
unix>
```

7.1.6 Automatic Backup and Restore to/from USB

On WeOS units equipped with a USB port, a USB memory stick can be used for automatic backup and restore. The intended application for the auto-backup function is to **simplify unit replacement** in case of unit failure.

Once activated, it works seamlessly. If a stick is already prepared nothing else is needed. If a unit fails you simply replace it, moving the USB stick to the replacement unit. Which must be of same mark and model. At first boot, the replacement unit automatically restores all necessary files from the faulty unit.

 **Note**

The auto-backup and restore function only handles configuration. It does **not** handle backup/restore of WeOS firmware images. You must not only ensure that your replacement unit is of the same model as the original unit. It should also have same WeOS firmware version loaded as the original unit.

Details of how to activate auto-backup, and how to perform restore are provided in [sections 7.1.6.1-7.1.6.2](#). [Section 7.1.6.3](#) contains information on USB directories for auto-backup and restore.

7.1.6.1 Procedure for activating auto-backup

- *Basic preparations the USB stick:* See [section 7.1.5.1](#) for formatting and partitioning requirement for USB memory sticks used with WeOS units.
- *Insert USB stick:* Insert the USB stick into WeOS unit and power it up.
- *Log in to CLI:* Log into the unit (CLI), either via console port or remotely via SSH (see [section 5.2](#)).
- *Activate auto-backup:* Run the CLI **"backup"** command.

 **Example**

```
example:/#> backup
WeOS Auto Backup & Restore for USB Media
=====
This command initializes a USB media, usually a memory stick, to be used for
automatic backup and restore of configuration files (including certificates).

Intended use-case is to have one memory stick for each device in the network
to ease replacement of faulty units.

The replacement WeOS unit will at boot automatically restore the backup and
```

```
seamlessly pick up where the faulty unit left off.  
  
Configuration and certificate files, including private keys (!) are backed up  
to /usb/westermo/backup/  
  
Activate WeOS auto-backup & restore on this USB stick, are you sure (y/N)? y  
Performing initial backup...  
Backup done.  
example/#>
```

The configuration files (including certificates and private keys) are now backed up to sub-directories under **"/usb/westermo/backup/"** (see [section 7.1.6.3](#)).

- *Keep USB inserted:* The USB memory stick should stay attached to the WeOS unit. Any changes to the configuration files on unit flash will be continuously backed-up to USB.

An alternative method to initialise auto-backup is to create the (empty) directory on the USB stick */westermo/backup/* (see [section 7.1.6.3](#)) before inserting it to the WeOS unit. Power off the unit and insert the USB stick. When the unit is then powered up, all configuration files (including certificates and private keys) will be backed up on the USB stick automatically. If you instead insert the prepared USB stick into a *running* unit, files start being backed up at your first (manual) save of the current configuration, e.g., **"cp running startup"** from CLI, or upon reboot of the unit.

7.1.6.2 Restoring configuration from USB to replacement unit

When booting a WeOS unit checks if a USB stick is attached. If a USB stick is found with *auto-backup* activated, the WeOS unit checks if a restore operation should take place or not. This automatic *restore* operation only takes place at boot-up (configuration file is copied from USB to on-board flash, and used as startup configuration), or within an interval of 30 seconds after boot-up. In the latter case, which can occur if the USB stick is not ready at system boot time, the WeOS unit starts with and runs the configuration on on-board flash for a short while; *restore* operation then updates both the startup-configuration and running configuration.

 **Note**

While replacing a WeOS unit using the USB auto-backup and restore support, it is recommended that the unit is disconnected from the network (see [step 5](#) in the procedure below), and therefore there should be no problem if the replacement unit runs with the configuration on the on-board flash for a short while. Still, if it is important that the restore operation takes place before the WeOS reads its startup configuration, an additional boot delay can be added (see [section 7.1.2.2](#) as well as [step 1](#) in the procedure below).

1. *Prepare replacement unit:* The replacement should be of the same model as the original unit (e.g., a Lynx L210-F2G should be replaced by another Lynx L210-F2G), and ensure that it has the same WeOS firmware version loaded as the original unit.

 **Hint**

If you are unsure of what firmware version your original unit was running, you can inspect the configuration file on your USB stick – at the top of the configuration file used as "**startup-configuration**" you should see the WeOS version, e.g., WeOS 4.15.2.

It is recommended that the replacement unit has **not** had the auto-backup feature activated already. If unsure, please do a factory reset¹¹ of the replacement unit before proceeding. Use either of the methods described in [section 7.1.3.2](#) (factory reset via console port), [section 7.1.3.3](#) (cable factory reset), or [section 7.2.3](#) (factory reset via web interface).

Optionally, you can then login to the replacement unit and set a *USB delay* in the *boot* context. For example, to extend the time to discover a USB stick at boot with up to 10 seconds, use the following commands:

 **Example**

```
example:/#> boot
example:/boot/#> usb
example:/boot/usb/#> timeout 10
```

¹¹Only files on unit flash (configuration file(s), IPsec certificates, etc.) will be affected by the factory reset. Files on an attached USB stick (if present) will not be affected.

This gives the USB stick more time to settle at boot, and be ready for use when configuration is activated (see remark at the start of this section). Suitable USB delay differs depending on what WeOS product you are using (boot time differs) and what USB stick you are using (see [section 7.1.5.1](#) for information on USB sticks verified for WeOS).

2. *Unplug power of replacement unit:* Before inserting the USB memory stick holding the backup configuration you should unplug the power of the replacement unit.
3. *Insert USB stick in replacement unit*
4. *Power up the replacement unit:* When the replacement unit boots, the configuration files on USB will automatically be restored to unit flash.
5. *Connect network cables:* It is recommended to connect the network cables *after* powering up the replacement unit. You may also connect them *before* powering up the unit (see comments on timings for detecting USB stick at the start of this section).
6. *Keep USB attached:* The USB memory stick should be stay attached to the WeOS unit. Any changes to the configuration files on unit flash will be continuously backed up to USB.

The automatic restore operation is only done when booting the WeOS unit, or within 30 seconds after boot-up¹². If the USB stick (holding backup information) is inserted into a running unit need to reboot the unit for the auto-restore operation to occur. Alternatively, you can run the CLI **"restore"** command to manually trigger it.

 **Example**

```
example:/#> restore
Restore backup from USB stick and activate to running-config, are you sure (y/N)? y
Stopping DHCP/DNS Server ..... [ OK ]
Starting DHCP/DNS Server ..... [ OK ]
example:/#>
```

7.1.6.3 Backup files in USB directory tree

Backup files will be stored on the USB in the following directory tree.

¹²The restore operation is **not** conducted if "auto-backup" is already activated on the WeOS unit **and** the "gen.id" counter on the USB and unit flash have the same value, see also [section 7.1.6.3](#).

```

/usb/
+-- westermo/
    +-- backup/      <-- Automatic Backup & Restore directory
        +-- cfg/     <-- Configuration files
        +-- crt/     <-- Certificates and keys
    
```

Additional details: The `"/usb/westermo/backup/cfg/"` directory will contain some additional files: `"startup-config.lnk"` specifies which config file is used as `"startup-configuration"`, and `"gen.id"` contains a counter. The corresponding `"gen.id"` file on unit flash is incremented every time a change on unit flash is detected. For every change the unit flash is synchronised to USB.

During the boot procedure, the `"gen.id"` values on USB and unit flash are compared. If equal, it is assumed that the configuration files are synchronised (no restore conducted). This is the case when rebooting a unit with auto-backup activated.

7.1.7 Configuration Deployment via USB

The *USB configuration deployment* function can be used for several purposes:

- *Easy configuration deployment of one or more WeOS units:* The USB stick is only attached during unit configuration, and can then be moved to the next unit to be configured.
- *To ensure a WeOS unit always boots up with a pre-defined configuration:* In this case, the USB stick will always be attached to the WeOS unit. The configuration on USB is copied to unit flash on every boot.

Note

For this use case, you may consider setting a boot delay ([section 7.1.2.2](#)) to avoid the risk that your unit starts with and temporarily uses the configuration on the on-board flash, see below for more explanations.

This "USB configuration deployment" function differs from "USB auto-backup and restore" described in [section 7.1.6](#) in that configuration changes applied after boot only apply to the WeOS unit's on-board flash – the configuration files on the USB memory stick are not affected.

- The model and WeOS version of the unit to be configured should match the intended configuration file(s) on the USB memory stick.

- The USB memory stick (prepared for deployment) is inserted before the unit is powered up. When the unit boots up configuration files will be copied from USB to unit flash, and used during startup configuration.
- The deployment function is also automatically activated if a USB stick (prepared for deployment) is detected up to 30 seconds after boot-up. In the latter case, which can occur if the USB stick is not ready at system boot time, the WeOS unit starts with and runs the configuration on on-board flash for a short while; *deployment* operation then updates both the startup-configuration and running configuration.

 **Note**

To prohibit that the unit first boots using configuration stored on the unit's on-board flash, you can setting a boot-delay (e.g., **"boot wait 10"** to extend the boot time with 10 seconds). By setting the delay large enough, the USB stick gets enough time to be ready when startup configuration is applied. Suitable boot delay differs depending on what WeOS product you are using (boot time differs) and what USB stick you are using (see [section 7.1.5.1](#) for information on USB sticks verified for WeOS)

- The *USB configuration deployment* function is activated if the directory *"westermo/deploy/"* is detected on an attached USB during boot-up. USB configuration deployment has *precedence* over USB auto-backup and restore. That is, if the USB memory stick contains both a *"westermo/deploy/"* and a *"westermo/backup/"* directory, the configuration deployment function will be activated.

[Section 7.1.7.1](#) provides information on the file structure and format of the files in the *"westermo/deploy/"* directory.

7.1.7.1 Deployment files in USB directory tree

Deployment configuration files should reside on the USB in the following directory tree.

```

/usb/
+-- westermo/
  +-- deploy/                                <-- USB Deploy
    +-- cfg/
      |   +-- <FILE>.cfg                    <-- Actual configuration file, e.g., config0.cfg
      |   +-- startup-config.lnk           <-- Windows style .lnk file
    
```

```
+-- crt/
+-- ...          <-- Certificates and keys
```

The *startup-config.lnk* file holds the file name of the startup configuration file. The format of this file is:

- No leading directories, to avoid any / or \ confusion
- No end-of-line after file name, to avoid any DOS/UNIX/Mac confusion
- File name stored at first position in file, e.g., *config0.cfg*

As of WeOS v4.33.0 there is no CLI or Web function for setting up a USB configuration deployment memory stick for use with WeOS. Meanwhile the easiest way might be to

1. perform a USB auto-backup (see [section 7.1.6.1](#)), and
2. plug the USB stick into a PC and rename the *backup* directory to *deploy*.

7.1.8 Certificate and Key Management

WeOS supports upload and management of certificate and key files. As of WeOS v4.33.0, use of certificates is limited to the Web server ([section 8.1.2](#)), IPsec VPNs ([chapter 37](#)) and SSL VPNs ([chapter 38](#)).

It is possible to upload/import PKCS#12 bundles containing *public certificate*, *private key* and the certificate of the issuing certificate authority (*CA certificate*). The PKCS bundle can be password protected (recommended).

It is also possible to upload individual certificate files in PEM format or OpenVPN static key files. For further information on certificate management, see [sections 7.2.5](#) (Web) and [7.3.33](#) (CLI).

A unique self-signed certificate will be generated for the Web server if no custom certificate has been chosen. The generated certificate will use the reserved label *web-default* and it will stay in the certificate repository until it is either deleted or a factory reset is performed. It is still recommended to use a custom certificate with the Web server, as the generated certificate is self-signed. See [section 7.2.5.1](#) (Web) and [7.3.33](#) (CLI) for uploading certificates, and [section 8.1.2](#) for applying a custom certificate to the Web server.

7.1.9 Protocol License Management

Some protocols supported in WeOS require the installation of an associated license file to enable the service.

As of WeOS v4.33.0, the Media Redundancy Protocol (MRP, see [chapter 19](#)) requires a license file. License files are unique per WeOS product.

**Note**

MRP licenses are ordered through the normal sales channels.

Information on how to import protocol license files to your WeOS device is found in [sections 7.2.7](#) (Web) and [7.3.35](#) (CLI).

7.1.10 Maintenance and diagnostic tools

The switch supports a set of maintenance and diagnostic tools:

Ping and Traceroute The standard Ping and Traceroute commands are available via the CLI and the Web, and are useful as basic troubleshooting tools.

WeOS Port Temporary Enable Used to temporary open disabled port(s) with or without a timeout. If the user doesn't specify a timeout, the port(s) will be set to operatively up with their configured timeout if there exists one. They will then stay up as long there is a link established and the timeout has not run out. If the user does specify a timeout, the port(s) will be set to operatively up with the specified timeout.

**Note**

The specified timeout is only a temporary timeout and does not change the port's configured timeout value.

WeOS Hardening Wizard Exists to help secure and reduce the surface vulnerability of the system. The wizard allows for disabling and configuring auto-disable timeout for one or more ports at a time.

WeOS IPConfig Client As mentioned in [chapter 3](#) WeOS provides the *WeConfig PC tool* for discovery and rudimentary management of Westermo switches. The CLI and the Web provides a similar mechanism (IPConfig client), i.e., once logged into the switch, it is possible to scan for other Westermo units on the same LAN.

Wake-On-LAN A Wake-On-LAN (WOL) client is available via the CLI and the Web. This allows a computer to be turned on or woken up by a network message (magic packet).

Additional features relevant for maintenance and diagnostics are described in [chapter 6](#) (SNMP), [chapter 11](#) (RMON Statistics), [chapter 26](#) (Port Monitoring) [chapter 27](#) (Event and Alarm Logging), and [chapter 25](#) (Alarm handling, Digital I/O and Front-panel LEDs).

7.2 Maintenance via the Web Interface

7.2.1 Managing switch firmware via the Web Interface

Menu path: Maintenance ⇒ F/W Upgrade

On the firmware upgrade page you are able to upgrade firmware by downloading an image using FTP/TFTP or by direct upload via the Web browser.

Firmware Upgrade

File Upload Upgrade

Image File	Browse...
------------	-----------

Upgrade

FTP/TFTP Upgrade

Image name	<input type="text"/>
Server address	<input type="text" value="192.168.2.3"/>

Upgrade

7.2.1.1 Firmware Upgrade Using File Upload

Image File	Select the file to upload (browser dependent).
Upgrade	Click the Upgrade button to initiate firmware upgrade.

7.2.1.2 Firmware Upgrade Using TFTP/FTP Server

Image name	The file name of the image file on the FTP/TFTP server.
Server address	The IP address of the FTP/TFTP server.
Upgrade	Click the Upgrade button to initiate firmware upgrade.



Note

If you use TFTP for upgrading with "pkg" files, make sure your TFTP server supports large files as defined in RFC2347[32].

7.2.2 Backup and Restore

Menu path: Maintenance ⇒ Backup&Restore

To create a backup of your switch configuration on your host, visit the *backup and restore* page.

Backup Configuration

To save the current configuration to your computer click the **Backup** button.

Backup

Restore Configuration

To restore a configuration, browse to the previously saved file and click **Restore**.

Browse...

backup_1f4100_dut1_20141104_1630.cfg

Restore

Backup	Click this button to download a copy of the running configuration on your switch. You will be asked to open or save the file. Normally chose save to save the file to your host. The behaviour is web browser specific and may also depend on your current browser settings. See Fig. 7.1 for an example.
File Path	Click the Browse button to browse for the file. The behaviour of the file selection is browser specific.
Restore	Click this button to restore the configuration the configuration described in the file you selected in <i>File Path</i> .

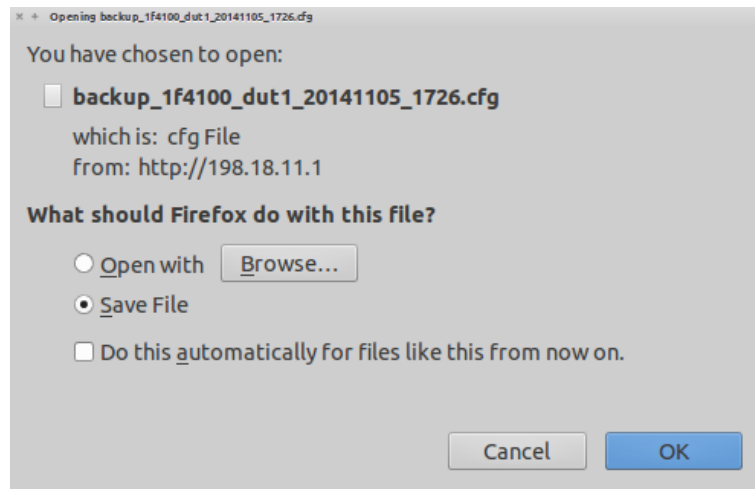

Figure 7.1: Example save dialogue (this example is from a Firefox browser)

7.2.3 Factory Reset

Menu path: Maintenance ⇒ Factory reset

To conduct a factory reset, press the *Reset* button.

Only configuration files on unit flash will be affected by a factory reset. Files on an attached USB stick (if present) will not be affected.

Factory reset

Do you want to restore all settings to factory default? Please note that all settings will be lost, including the IP-address.
The unit will be rebooted!

Reset

7.2.4 Restart

Menu path: Maintenance ⇒ Restart

To restart the switch press the *Restart* button.

Restart

Are you sure you want to restart the unit?







Restart

7.2.5 Managing certificates and keys

Menu path: Maintenance⇒Certificates



When entering the certificates page you will be presented to a list of all certificates and keys available on your switch. Here you can import or delete certificates/keys.

Certificates Management

Type	Label	Common Name (CN)	Expires	
Public	client1	client1	Nov 16 09:29:21 2016 GMT	 
CA	client1	rdCA	Nov 16 09:15:52 2021 GMT	 
Private	client1			
OpenVPN	mylabel			

Import

Type	The type of certificate/key: Public (regular certificate), Private (a private key belonging to a regular certificate), CA (a CA certificate), or OpenVPN (an OpenVPN static key).
Label	A label identifying the certificate/key. Unique per certificate file type (Public, Private, CA and OpenVPN). Max label length is 22 characters.
Continued on next page	

Continued from previous page	
Common Name (CN)	The common name (CN) part of the distinguished name (DN) found in the imported certificate's subject.
Expires	The date of expiration for the certificate.
 Delete	Click this icon to remove a certificate/key. You will be asked to acknowledge the removal before it is actually executed.
 Details	Click this icon to display details regarding a certificate.
Import	Click this button to import a certificate or key.

7.2.5.1 Import Certificates

Menu path: Maintenance ⇒ Certificates ⇒ **Import**

When clicking the **Import** button you will be presented to the certificate import page where you can import PKCS#12 certificate bundles, certificates and private key files in PEM format, or an OpenVPN static key.

Import Certificate

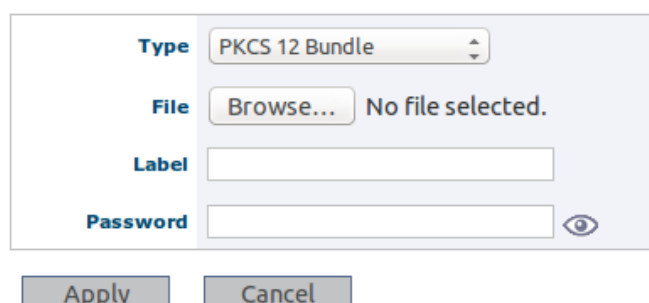

Type	Select the type of file to import (PKCS#12 bundle, PEM file or OpenVPN static key file).
File	Browse your file system for the file to import by clicking the Browse ... button.
Type of Certificate	(Only for PEM files) Declare the type of PEM file to upload: Public (regular certificate), Private (a private key), or CA (a CA certificate).
Continued on next page	

Continued from previous page	
Label	Enter a label for identification of the certificate/key. The file-name (base part) will be used as label if left empty. E.g. if uploaded file name is <i>mycert.p12</i> , the label will be <i>mycert</i>
Password	(Only for PKCS#12 bundles) If your certificate bundle is password protected, you have to enter the password or the import will fail.

7.2.5.2 Certificate Details

Menu path: Maintenance ⇒ Certificates ⇒ 

Certificate Details

Label	RoadWarrior
Subject	C=SW, ST=Some-State, L=Vas, O=WE, OU=RD, CN=Charlie Brown, emailAddress=charlie@brown.comics

Certificate Dump

```
Certificate:
Data:
  Version: 3 (0x2)
  Serial Number:
    ac:41:35:80:2f:9f:2e:aa
  Signature Algorithm: sha1WithRSAEncryption
  Issuer: C=SW, ST=Some-State, L=Vas, O=WE, OU=RD, CN=Charlie Brown, emailAddress=charl
  Validity
    Not Before: Oct 11 05:01:44 2000 GMT
    Not After: Oct 11 05:01:44 2000 GMT
```

Label	A unique label identifying the certificate (max length 22 characters).
Common Name (CN)	The common name (CN) part of the distinguished name (DN) found in the imported certificate subject.
Certificate Dump	A raw dump of the certificate.













To exit the details page, select a menu option in the navigation menu.





7.2.6 Managing SSH Host Keys

Menu path: Maintenance⇒Keys⇒SSH Host Keys

When entering the SSH Host Key page you will see the list of existing SSH Host Keys. Here you can display the public part and fingerprint of existing host keys, import, export and regenerate these keys.

SSH Host Keys

Type	Fingerprint	
rsa	sha1!! a0:35:6c:2a:ea:4e:1d:0c:39:17:38:3d:94:10:8b:aa:8b:86:8f:d9	   
dss	sha1!! 63:68:e4:fc:0d:e6:bc:64:c0:cb:23:45:15:35:dd:b5:63:1e:5c:d9	   
ecdsa	sha1!! 2a:86:26:83:90:78:91:16:bd:03:91:7b:d6:5e:19:6c:20:e2:da:d7	   

Type	The SSH host key type.
Fingerprint	Displays the SSH host key fingerprint along with the hash algorithm used to calculate it.
	Generate a new SSH host key.
	Import a new base64 encoded SSH host key.
	Export an existing SSH host key as base64 encoded text.
	Displays additional information about a specific SSH host key.

7.2.7 Managing Protocol Licenses

Menu path: Maintenance⇒Licenses

When entering the licenses page you will be presented to a list of all licenses available on your switch. Here you can import or delete licenses.

Licenses

Installed licenses for device, Article Number: **3643-0205-001**, Serial Number: **3434**.

Product	License valid	Article Number	Serial Number	
MRP	✓	3643-0205	3434	

Product	The Protocol/Service the License concerns.
License Valid	States whether the installed license is valid for this product or not.
Article Number	Article number associated with this license. The article number and serial number are used to identify the WeOS product the license is valid for. (Only the first 8 digits of the article number are valid, although some products have longer article numbers.)
Serial Number	Serial number associated with this license. The article number and serial number are used to identify the WeOS product the license is valid for.
 Delete	Click this icon to remove a license. You will be asked to acknowledge the removal before it is actually executed.
Import	Click this button to import a license.

7.2.7.1 Import License

Menu path: Maintenance ⇒ Licenses ⇒ **Import**

When clicking the **Import** button you will be presented to the license import page where you can import a license file.

Import license

License file

License file	Browse your file system for the file to import by clicking the Browse ... button.
---------------------	--

7.2.8 Hardening tool

With this tool you can configure one or more ports to be disabled or have a auto-disable timeout.

Menu path: Tools ⇒ Hardening

Hardening Wizard

Port state and timeout

	Port	Link	Admin Status	Oper. Status	Timeout
<input type="checkbox"/>	1	DOWN	Disabled	Disabled	None
<input type="checkbox"/>	2	DOWN	Disabled	Disabled	None
<input type="checkbox"/>	3	DOWN	Enabled	Enabled	None
<input type="checkbox"/>	4	DOWN	Enabled	Enabled	None
<input type="checkbox"/>	5	DOWN	Enabled	Enabled	None
<input type="checkbox"/>	6	DOWN	Enabled	Enabled	None
<input type="checkbox"/>	7	DOWN	Enabled	Enabled	None
<input checked="" type="checkbox"/>	8	UP	Enabled	Enabled	None
<input type="checkbox"/>	9	UP	Enabled	Enabled	None
<input type="checkbox"/>	10	UP	Enabled	Enabled	None

Disable

Enable

Timeout sec

Port	The port label.
Link	The status of the link. Up or Down.
Admin status	Enabled / Disabled in configuration.
Oper. status	Enabled / Disabled / Disabled because of time out.
Timeout	Configured auto-disable timeout in seconds. "None" specifies there is no timeout set.

7.2.9 Ping tool

Ping is useful as a basic diagnostic tool. The output on the web is displayed once the ping command has completed. If the command takes too long to execute the web page may time out.

Menu path: Tools ⇒ Ping

Ping

Address
Interface
Ping Count
Packet Size (bytes)

```

PING 198.18.11.1 (198.18.11.1): 56 data bytes
64 bytes from 198.18.11.1: seq=0 ttl=64 time=0.230 ms
64 bytes from 198.18.11.1: seq=1 ttl=64 time=0.150 ms
64 bytes from 198.18.11.1: seq=2 ttl=64 time=0.159 ms

--- 198.18.11.1 ping statistics ---
3 packets transmitted, 3 packets received, 0% packet loss
round-trip min/avg/max = 0.150/0.179/0.230 ms
    
```

Address	The network host to send ICMP ECHO REQUEST packets to
Ping Count	Defines the number of ICMP packets to send.
Packet Size	Alters the default size of the ICMP packets. This only only increases the empty payload of the packet

7.2.10 Traceroute tool

Trace the route packets take to a network host. The output on the web is displayed once the ping command has completed. If the command takes too long to execute the web page may time out.

Menu path: Tools ⇒ Trace

Traceroute

Address
Maximum Hops
Maximum Wait time (s)

```

traceroute to www.westermo.se (85.24.138.221), 20 hops max, 38 byte packets
 1 192.168.2.1 (192.168.2.1)  4.368 ms  1.590 ms  1.489 ms
 2 192.168.131.1 (192.168.131.1)  4.725 ms  4.914 ms  5.004 ms
 3 213.132.98.33 (213.132.98.33)  5.891 ms  5.649 ms  5.503 ms
 4 sebot0001-rc3.ip-only.net (82.99.32.1)  5.659 ms  5.691 ms  5.537 ms
 5 sebot0001-rc4.ip-only.net (62.109.44.70)  5.775 ms  13.957 ms  5.944 ms
 6 sesto0001-rc4.ip-only.net (82.99.32.62)  13.743 ms  29.645 ms  6.799 ms
 7 netnod-ix-ge-a-sth-1500.bahnhof.net (194.68.123.85)  12.959 ms  6.765 ms  6.723 ms
 8 sto-crl.pio-dr3.bahnhof.net (85.24.151.225)  7.186 ms  7.272 ms  7.106 ms
 9 pio-dr3.pio-dr1.bahnhof.net (85.24.151.97)  7.298 ms  7.262 ms  7.042 ms
10 h-85-24-138-221.na.cust.bahnhof.se (85.24.138.221)  7.652 ms !C  7.262 ms !C  7.792 ms !C
  
```

Address	The network host
Maximum Hops	Max time-to-live (number of hops).
Maximum Wait time	Set the delay, in seconds, before timing out a probe packet

7.2.11 IPConfig scan tool

Scan network for IPConfig neighbours. The output on the web is displayed once the ping command has completed. If the command takes too long to execute the web page may time out.

Menu path: Tools ⇒ IPConfig

IPConfig

Interface

Flash On LED.

MAC	IP	Ver.	Type	Status
00:07:7c:82:36:07	192.168.2.200/24	9.99	RedFox	-----RSI
00:07:7c:86:f1:63	192.168.2.226/24	9.99	Wolverine DDW-226	-----MSI
00:07:7c:86:48:81	192.168.2.154/24	4.02	Lynx 1400G	-----MSI
00:07:7c:81:13:5a	192.168.2.214/24	9.99	Wolverine DDW-222	-----
00:07:7c:80:40:3a	192.168.2.85/24	3.13	Lynx 1400	-----S-

Interface	The interface to scan
Flash On LED.	If enabled, this unit will flash the on LED, while scanning

7.2.12 Wake-On-LAN

The Wake-On-LAN (WOL) allows computers to be turned on or woken up by a network message (magic packet).

Menu path: Tools ⇒ WOL

2 Magic Packet(s) successfully sent.

Wake On LAN

Interface	<input type="text" value="vlan1"/>
MAC Addresses	<input type="text" value="00:24:01:0c:d2:14"/> <input type="text" value="00:12:79:a1:34:0e"/>
<input type="button" value="Wake"/>	

Interface	The interface to send the magic packet on.
MAC Addresses	The MAC Addresses of the computers to wake

7.2.13 Tech support

The Tech support collects system information (hardware, status and configuration) and delivers it as a compressed file. Note: The configuration is included with passwords. The file format is compressed tar archive(tar.gz).The filename has the format of

<LOCATION>_<HOSTNAME>_<YYYYMMDD>_<HHMMSS>.tar.gz, if the location field is not set, the last three octets of the mac-address will be used.

Menu path: Tools ⇒ Tech Support

Tech Support

To create a Tech support file, click the **Create** button.

The Tech support is a compressed tar-file with collected system information and log files.

Including [running config](#) and [startup config](#).

Warning: Passwords and other sensitive information may be included in the report

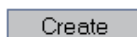

Clicking **Create** will create a Tech support file. Once the file is created you will be presented with the following dialogue.

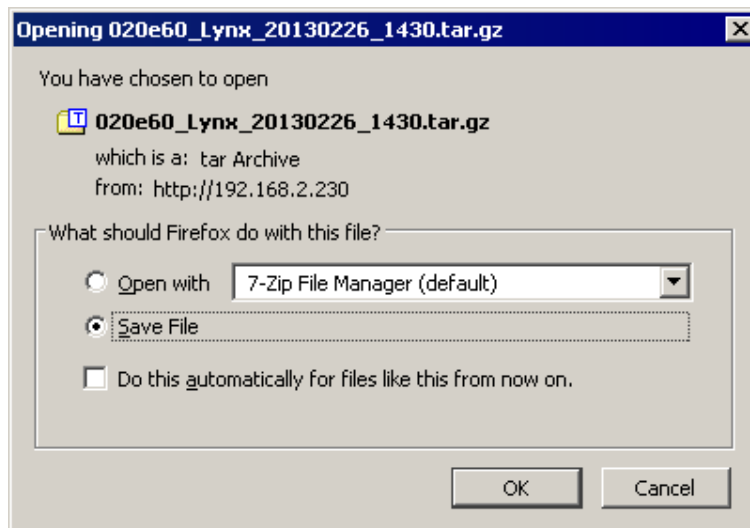

The Tech support file consist of a number of text files. Configuration files can be found in the /cfg directory of the archive, and log files under the /var/log sub-directory.

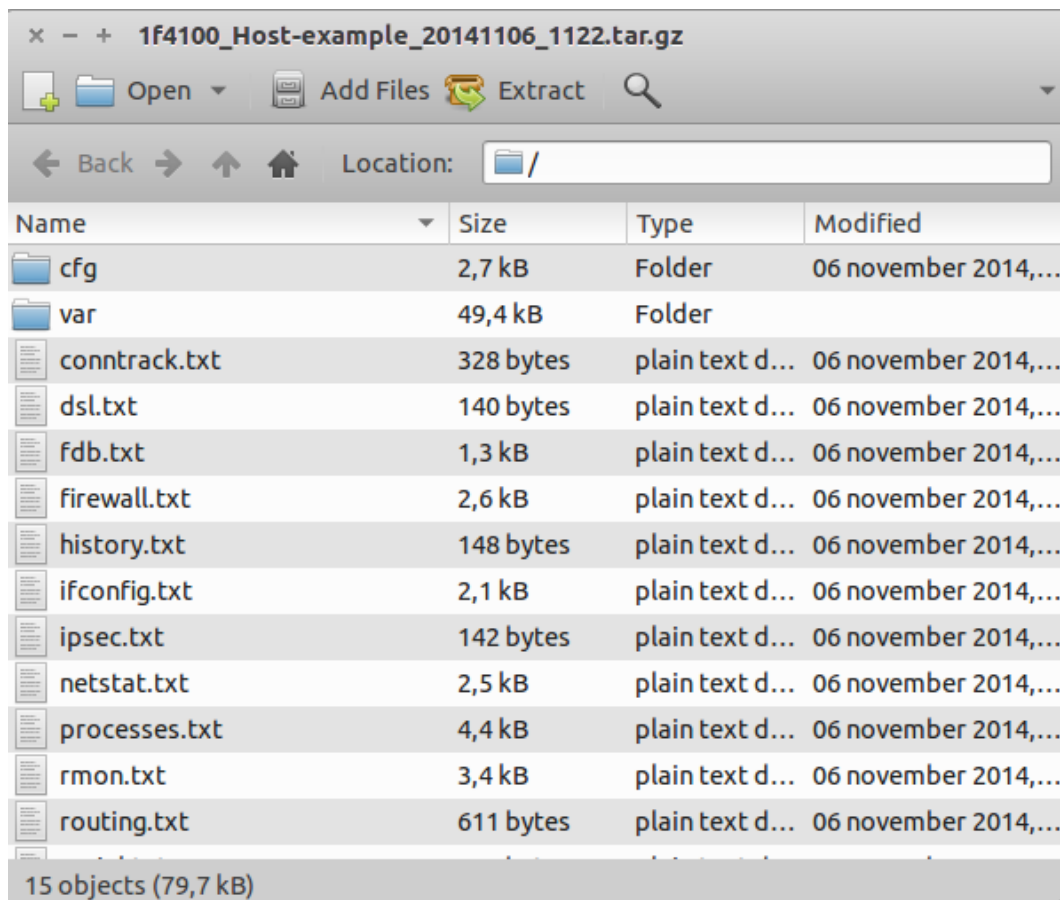

7.3 Maintenance via the CLI

Command	Default	Section
<u>Firmware Upgrade</u>		
upgrade [force] <pri sec boot> <IPADDR FILENAME URI://. . . >		Section 7.3.1
show system-information		Section 7.3.2
<u>System Boot Options</u>		
boot	N/A	Section 7.3.3
[no] cable-reset	Enabled	Section 7.3.4
[no] boot-order <flash bootp>	Flash	Section 7.3.5
[no] bootp	N/A	Section 7.3.6
[no] timeout <0-1800>	300	Section 7.3.7
[no] mac <offset <num> address <MACADDRESS>>	offset 1 ¹³	Section 7.3.8
[no] vfs-target <flash usb>	Disabled	Section 7.3.9
[no] console	N/A	Section 7.3.10
[no] password-reset	Enabled	Section 7.3.11
[no] factory-reset	Enabled	Section 7.3.12
[no] usb	N/A	Section 7.3.13
[no] enable	Enabled	Section 7.3.14
[no] timeout <1-60>	Disabled	Section 7.3.15
[no] loader	N/A	Section 7.3.16
[no] login <password hash> <STRING>	Disabled	Section 7.3.17
[no] rescue-port <UDPPORT>	6000	Section 7.3.18
[no] rescue-address <IPADDR>	192.168.2.200	Section 7.3.19
[no] rescue-netmask <NETMASK>	255.255.255.0	Section 7.3.20
[no] rescue-peer <IPADDR>	192.168.2.1	Section 7.3.21
<u>Port, VLAN, and Interface Tools</u>		
port <up [timeout SEC] down> PORT		Section 7.3.22
show port [PORT]		Section 7.3.22
show vlan [VID]		Section 7.3.23
show iface [IFNAME]		Section 7.3.24

Continued on next page

¹³See command description for details and exceptions.

Continued from previous page		
Command	Default	Section
<u>File handling (Configuration, Log, etc.) and Reboot</u>		
dir <cfg:// log:// usb://>		Section 7.3.25
copy <FROM_FILE> <TO_FILE>		Section 7.3.26
erase <file>		Section 7.3.27
show <running-config startup-config factory-config [<filesystem>://]FILENAME>		Section 7.3.28
backup		Section 7.3.29
restore		Section 7.3.30
reboot		Section 7.3.31
show hash		Section 7.3.32
<u>Certificate and Key Management</u>		
cert import <pkcs pem ovpn> [...] <URI>		Section 7.3.33
no cert [force] [LABEL]		Section 7.3.33
show cert [LABEL]		Section 7.3.34
<u>License Management</u>		
[no] license <[PROTO]> import <URI>>		Section 7.3.35
<u>Maintenance and Diagnostic tools</u>		
ping [iface <IFNAME>] [size <BYTES>] [count <NUM> [ttl <NUM>] <HOST>		Section 7.3.36
traceroute <IPADDR>		Section 7.3.37
ssh [USER@]<IPADDR DNAME>[/PORT]	admin/22	Section 7.3.38
ssh-host-key [generate TYPE [size SIZE]] [import export TYPE]		Section 7.3.39
[no] ssh-user-key [import USER]		Section 7.3.40
telnet <IPADDR DNAME> [PORT]	23	Section 7.3.41
show ipconfig <IFNAME>		Section 7.3.42
wake-on-lan <IFNAME> <MACADDR>		Section 7.3.43
<u>Other maintenance commands</u>		
date [[YYYY-MM-DD]hh:mm[:ss]]		Section 8.3.7

Continued on next page

Continued from previous page		
Command	Default	Section
[no] timezone <TIMEZONE>		Section 8.3.5
show timezone [QUERY SUBSTRING]		Section 8.3.8
show env		Section 7.3.44
show uptime		Section 7.3.45
show memory		Section 7.3.46
show processes		Section 7.3.47
show flash-table		Section 7.3.48
show partitions		Section 7.3.49

7.3.1 Upgrading firmware

Syntax upgrade [force] <pri|sec|boot> <IPADDR> <FILENAME>
 upgrade [force] <pri|sec|boot> URI://<ADDRESS>/PATH/<FILENAME>

Context Admin Exec

Usage Upgrade primary, secondary, or bootloader firmware via FTP, TFTP or USB stick. In the first form, upgrade attempts to download and install *FILENAME* via FTP from a server at *IPADDR*. If no FTP server is available, the command tries to download the file using TFTP instead.

 **Note**
 If you use TFTP for upgrading with "pkg" files, make sure your TFTP server supports large files as defined in RFC2347[32].

The second form uses a URI based format. The same format used in the copy command, not all URIs are supported though, only ftp://, tftp:// and usb://. In the usb:// case there is of course no need to give an ADDRESS, and PATH is optional. Also, some units may not have a USB port.

In the second form of the command it is also possible use an Internet name (FQDN), instead of just an IP address. For this to work you need to have first setup a valid name server in the configuration.

Before the actual "Flashing" starts, i.e. when upgrade is still downloading or checking the downloaded image CRC, it is possible to abort the upgrade

using Ctrl-C (BREAK). However, once the actual flashing starts the BREAK signal, and other blockable signals, is completely disabled to prevent accidental destruction of the device partition and image contents.

The **"force"** keyword can be used to bypass the image signature check. This should only be used as a last resort and MAY BRICK THE DEVICE if the wrong image is used. Please verify carefully that you are using the correct image for the device being upgraded if using **"force"**.

After installing a *primary firmware*, the switch will automatically be rebooted. (More precisely: after installing a *primary firmware*, the switch will automatically be rebooted given that the system booted from the primary image. Similarly, after installing a *secondary firmware*, the switch will automatically be rebooted given that the system booted from the secondary image.)

Caution! Only conduct upgrades over a stable network connection. Ensure that the switch is not powered off while the downloaded firmware is being installed.

Default values N/A

Examples **"upgrade primary 192.168.1.1 WeOS-4.15.1.pkg"** will download and install a new primary image named *WeOS-4.15.1.pkg*, from a FTP/TFTP server at *192.168.1.1*.

"upgrade boot 192.168.1.1 WeOS-4.15.1.pkg" will download and install a new bootloader image included in the pkg file (*WeOS-4.15.1.pkg*) from a FTP/TFTP server at *192.168.1.1*.

"upgrade pri usb://WeOS-4.15.1.pkg" upgrades primary firmware on a WeOS unit using pkg file *WeOS-4.15.1.pkg* present on a USB stick. Check if the USB stick has been *mounted* first using the **"dir usb://"** command.

7.3.2 Show System Information

Syntax show system-information

Context Admin Exec

Usage List general system information such as serial number, firmware version, contained hardware, etc.

Default values Not applicable

```

 Example
example:/#> show system-information

System Information
=====
System Name       : example
System Contact    :
System Location   :
System Timezone   : Etc/UTC

Product Family    : RedFox           Model           : RFIR-219-F4G-T7G-AC
Architecture      : mpc85xx         Base MAC Address : 00:07:7c:15:5f:20
Platform          : Corazon         Class           : Extended
Article number    : 3641-4015       Serial Number    : 1037
Boot loader ver.  : 2014.06.0-1     Active firmware  : Main
Main firmware ver.: 4.15.2         Backup firmware ver: 4.15.2
Manufacturing date : Sep 24, 2014

Card #1 =====
Type              : CPU
Chipset           : MV88E6352 r1
Article no        : 5013-1010
Revision          : 0
Batch id          : 140915-01274960-00001
Channel interfaces : 2
Bandwidth limit   : Disabled (for CPU channels)
... (More info follows)
example:/#>

```

7.3.3 Manage Boot Options

Syntax boot

Context Admin Exec context

Usage Enter System Bootstrap context to configure device specific boot settings. These settings are stored separately, i.e., outside the regular configuration file.

Use **"show boot"** to view a summary of the boot option settings.

Default values N/A

Example

```
example:/#> show boot
Device Bootstrap Configuration =====
Boot order      : flash
Cable reset     : Enabled

Console Functions
  Password reset : Enabled
  Factory reset  : Enabled

USB Functions
  Status        : Enabled
  Timeout       : Disabled
example:/#>
```

7.3.4 Enable/Disable Cable Factory Reset

Syntax [no] cable-reset

Context [System Bootstrap](#) context

Usage Enable/disable the cable factory reset mechanism.

The cable factory reset mechanism enables you to conduct a factory reset without using the console port or being logged into the unit. When disabled, the console port remains the last means to perform a factory reset.

Disabling cable factory reset speeds up the boot and, for some installations, reduces the risk of inadvertently triggering a factory reset on devices where only one looped cable is required to perform factory reset.

Use **"cable-reset"** to enable and **"no cable-reset"** to disable cable factory reset.

Use **"show cable-reset"** to show the current setting.

Default values Enabled

Example

```
example:/#> boot
example:/boot/#> no cable-reset
example:/boot/#> show cable-reset
Disabled
```

```
example:/boot/#> end
example:/#>
```

7.3.5 Set Boot Order

Syntax [no] boot-order <flash|bootp|usb>

Context [System Bootstrap](#) context

Usage Select Boot Order for *configuration file*¹⁴.

As of WeOS v4.33.0 the **"boot-order"** has the following limitations:

- **"boot-order"** can only be used to select a single boot media, not a list. That is, you can select either **"flash"** or **"bootp"**, but not both.

 **Note**
The WeOS unit will fall-back to find its startup-configuration from on-board flash when other methods such as **"bootp"** fails.

- The alternative **"boot-order usb"** (referred to as "boot from USB") is only available as *technology preview*. See WeOS release notes for more information on WeOS technology previews in general and for specific information on the "boot from USB" function.

Use **"no boot-order"** to reset the boot-order to the default setting.

Use **"show boot-order"** to view the configured boot order. Flash will listed as second choice if **"boot-order bootp"** is set.

Default values Flash

 **Example**

```
example:/#> boot
example:/boot/#> show boot-order
flash
example:/boot/#> boot-order bootp
example:/boot/#> show boot-order
bootp, flash
example:/boot/#> end
example:/#>
```

¹⁴Future versions of WeOS may include support for boot order of software image files.

7.3.6 Manage BOOTP Bootstrap Settings

Syntax [no] bootp

Context [System Bootstrap](#) context

Usage Enter System Bootstrap BOOTP context to configure settings for BOOTP boot services.

"no bootp" will reset the BOOTP bootstrap settings to default.

Use "show bootp" to list BOOTP bootstrap settings (also available as "show" command within the System Bootstrap BOOTP context).

Default values N/A

7.3.7 BOOTP timeout

Syntax [no] timeout <0-1800>

Context [System Bootstrap](#) [BOOTP](#) context

Usage Set timeout in seconds to wait for BOOTP server response.

If no BOOTP response is received from the BOOTP/DHCP server, new BOOTP Requests will be re-transmitted up to the given timeout interval.

To avoid congestion, the Requests are re-transmitted randomised around an exponential back-off interval; the back-off interval is doubled for each request up to 60 seconds.

The BOOTP client will wait one extra back-off interval after the last transmitted request, thus the actual timeout can be roughly 60 seconds longer than configured.

Use "no timeout" to reset the timeout to default.

Default values 300 (seconds)

7.3.8 BOOTP source MAC address

Syntax [no] mac <offset <num> | address <MACADDRESS>>

Context [System Bootstrap](#) [BOOTP](#) context

Usage Set MAC address for BOOTP request. The source MAC-address used in BOOTP request can be:

- offset relative to system base MAC: Typically used this if you wish your product to use a MAC match the MAC of a specific LAN interface on your unit.
- a statically configure MAC: Assign a specific MAC address to use for BOOTP for this unit.

By default the source MAC is an offset to system base MAC, which would match the MAC assigned to interface *vlan1*. On most WeOS products this would mean **"mac offset 1"** (exceptions are products with more than one CPU channel; the offset equals the number of CPU channels by default).

 **Note**

See [sec. 7.3.2](#) and [15.4.16](#) for information on CPU base MAC and CPU channels. For more information on how a LAN interface is assigned its MAC address, see [section 22.2.4](#).

Use **"no mac"** to reset the BOOTP MAC setting to default.

Use **"show mac"** to show the BOOTP MAC setting.

Default values offset 1 (or more generally, the offset equals the number of CPU channels of the product.)

 **Example**

```
example:/#> show iface
Press Ctrl-C or Q(uit) to quit viewer, Space for next page, <CR> for next line.

Interface Name   Oper   Address/Length   MTU   MAC/PtP Address
-----
lo                UP     127.0.0.1/8      16436  N/A
vlan1            UP     192.168.2.200/24 1500   00:07:7c:84:91:65
-----

example:/#> boot
example:/boot/#> bootp
example:/boot/bootp/#> show mac
00:07:7c:84:91:65 (offset 1)
example:/boot/bootp/#>
```

7.3.9 Storage of BOOTP configuration file (VFS target)

Syntax [no] `vfs-target <flash|usb>`

Context [System Bootstrap BOOTP](#) context

Usage Set virtual file system (VFS) target for configuration file.

Use this setting to save the retrieved file in a non-volatile location. By default all configuration files retrieved over BOOTP are temporary, and will be lost when rebooting the system, unless an operator saves a copy with an explicit **"copy running-config cfg://mybackup.cfg"** or similar (e.g., Web 'Apply' or SNMP Set).

Set to **"vfs-target flash"** to automatically save to built-in flash (*startup-config*), or **"vfs-target usb"** to save to an external USB stick.

Use **"no vfs-target"** to disable the setting to get the default behaviour where the file is stored in RAM only.

Use **"show vfs-target"** to show the VFS target setting.

Default values Disabled (i.e., store in RAM only)

7.3.10 Manage Console Settings

Syntax [no] console

Context [System Bootstrap](#) context

Usage Enter System Bootstrap Console context to configure settings related to the console, or functions only available from the console.

"no console" will reset all console settings to default.

Use **"show console"** to list all console settings (also available as **"show"** command within the System Bootstrap Console context).

Default values N/A

7.3.11 Enable/Disable Console Password Reset

Syntax [no] password-reset

Context [System Bootstrap Console](#) context

Usage Enable or disable the function to reset the admin user's password from the console port.

Use **"no password-reset"** to disable the password/reset login.

Use **"show password-reset"** to show whether it is enabled or disabled.

Default values Enabled

Example

```
example:/#> boot
example:/boot/#> show console
  Password reset : Enabled
  Factory reset  : Disabled
example:/boot/#> console
example:/boot/console/#> no password-reset
example:/boot/console/#> show
  Password reset : Disabled
  Factory reset  : Disabled
example:/boot/console/#>
```

7.3.12 Enable/Disable Console Factory Reset

Syntax [no] factory-reset

Context [System Bootstrap Console](#) context

Usage Enable or disable the function to reset the device to factory defaults from the console port.

Use **"no factory-reset"** to disable the factory/reset login.

Use **"show factory-reset"** to show whether it is enabled or disabled.

Default values Enabled

Example

```
example:/#> boot
example:/boot/#> show console
  Password reset : Disabled
  Factory reset  : Enabled
example:/boot/#> console
example:/boot/console/#> no factory-reset
example:/boot/console/#> show
  Password reset : Disabled
  Factory reset  : Disabled
example:/boot/console/#>
```

7.3.13 Manage USB Bootstrap Settings

Syntax [no] usb

Context [System Bootstrap](#) context

Usage Enter System Bootstrap USB context to configure settings for USB boot services.

"no usb" will reset the USB settings to default.

Use "show usb" to list configured USB settings (also available as "show" command within the System Bootstrap USB context).

Default values N/A

7.3.14 Enable/disable USB Bootstrap Services

Syntax [no] enable

Context System Bootstrap USB context

Usage Enable or disable USB bootstrap services.

Use "no enable" to disable USB bootstrap services: *USB automatic backup/restore* and *USB deployment*¹⁵. It is still possible to perform manual "backup" (see [section 7.3.29](#)) and manual "restore" see [section 7.3.30](#)).

Use "show enable" to show whether USB bootstrap functionality is enabled or disabled.

Default values Enabled

 **Example**

```
example:/#> boot
example:/boot/#> show usb
  Status      : Enabled
  Timeout     : Disabled
example:/boot/#> usb
example:/boot/usb/#> no enable
example:/boot/usb/#> show
  Status      : Disabled
  Timeout     : Disabled
example:/boot/usb/#>
```

7.3.15 USB wait timeout

Syntax [no] timeout <1-60>

Context System Bootstrap USB context

¹⁵"no enable" also disables the *technology preview* feature "boot from USB", see also [section 7.3.5](#)

Usage Set timeout in seconds for USB stick to settle at boot.

Some USB sticks cannot be accessed immediately at power-up. This setting can be used to fine tune the time the system waits for a USB stick to settle.

The system bootup time will be prolonged up to the given timeout, unless the system discovers the USB stick before.

Default values Disabled (no timeout)

Example

```
example:/#> boot
example:/boot/#> usb
example:/boot/usb/#> timeout 10
example:/boot/usb/#> show
    Status      : Enabled
    Timeout     : 10 second(s)
example:/boot/usb/#> leave
example:/#>
```

7.3.16 Manage bootloader settings (Barebox)

Syntax [no] loader

Context [System Bootstrap](#) context

Usage Enter System Bootloader context to configure settings related to the (Barebox) bootloader boot-menu. (You enter the *boot-menu* by pressing *Ctrl-C* on the console port when a unit boots.

Note

The System Bootloader context is only available for products running the Barebox bootloader.

"no loader" will reset all bootloader settings to default.

Use "show loader" to list all bootloader settings (also available as "show" command within the System Bootloader context.

Default values N/A

 **Example**

```
example:/boot/#> show loader
Device Bootloader Configuration:

Login Password: Disabled

Rescue Mode Settings:
Address: 192.168.2.200
Netmask: 255.255.255.0
Peer   : 192.168.2.1
Port   : 6000
example:/boot/#>
```

7.3.17 Setting boot-menu password (Barebox)

Syntax [no] login <password|hash> <STRING>

Context [System Bootloader](#) context

Usage Configure a boot-menu login password. Setting a boot-menu password is recommended to improve security. When a password is configured, a user must provide the correct password to enter the boot-menu at system bootstrap.

When setting the password, you can either enter it as is ("**login password** <STRING>"), or provide a SHA1 hash of the password ("**login hash** <STRING>").

Use "**no login**" to disable the boot-menu login password.

Use "**show login**" to see if a boot-menu login password is set or not.

Default values Disabled (no login)

 **Example**

```
example:/boot/loader/#> login password TopSecret
example:/boot/loader/#> end
Saving bootloader configuration to FLASH
100% / [=====]
example:/boot/#>
```

7.3.18 Setting rescue console UDP port (Barebox)

Syntax [no] rescue-port <UDPPORT>

Context [System Bootloader](#) context

Usage Configure UDP port for rescue-mode netconsole, e.g., "**rescue-port 12345**". This is used as the local and remote port number for the UDP rescue console. Defaults to UDP port 6000.

Use "**no rescue-port**" to reset UDP port to the default (6000). Use "**show rescue-port**" to show the configured UDP port.

Default values 6000

7.3.19 Setting rescue console local IP address (Barebox)

Syntax [no] rescue-address <IPADDR>

Context [System Bootloader](#) context

Usage Configure local IP address for rescue-mode netconsole, e.g., "**rescue-address 10.0.1.1**". This is used as the local IP for rescue console. Defaults to address 192.168.2.200.

This address is also used as default local IP address when selecting TFTP boot-image download (technology preview) within the boot-menu (at startup).

Use "**no rescue-address**" to reset local IP for rescue console to 192.168.2.200. Use "**show rescue-address**" to show the configured address.

Default values 192.168.2.200

7.3.20 Setting rescue console netmask (Barebox)

Syntax [no] rescue-netmask <IPADDR>

Context [System Bootloader](#) context

Usage Configure local IP address netmask for rescue-mode netconsole, e.g., "**rescue-netmask 255.255.0.0**". Defaults to netmask 255.255.255.0.

Use "**no rescue-netmask**" to reset netmask for rescue console interface to 255.255.255.0 Use "**show rescue-netmask**" to show the configured netmask.

This netmask is also used as default rescue interface netmask when selecting TFTP boot-image download (technology preview) within the boot-menu (at startup).

Default values 255.255.255.0

7.3.21 Setting rescue console peer IP address (Barebox)

Syntax [no] rescue-peer <IPADDR>

Context [System Bootloader](#) context

Usage Configure peer IP address for rescue-mode netconsole, e.g., "**rescue-peer 10.0.1.2**". This is used as the peer IP for rescue console. Defaults to address *192.168.2.1*.

This address is also used as default peer IP address when selecting TFTP boot-image download (technology preview) within the boot-menu (at startup).

Use "**no rescue-peer**" to reset local IP for rescue console to 192.168.2.1.
Use "**show rescue-peer**" to show the configured address.

Default values 192.168.2.1

7.3.22 Port Status and Tools

Syntax show port [PORT]
port <up [timeout SEC]| down> <PORT>

Context [Admin Exec](#)

Usage Show port status, or control operational state of port.

A port configured as "**no enable**" can be temporarily enabled using the [Admin Exec](#) command "**port up PORT**". When the device is rebooted the port will resume its configured state. Similarly, "**port down PORT**" can be used to temporarily disable a port configured as enabled.

A port configured with automatic disable can be temporarily enabled with the configured timeout using the same "**port up PORT**" command.

All disabled ports can also be temporarily enabled with a timeout value (in seconds), regardless of the port's configured setting, using the "**port up timeout SEC PORT**" command.

7.3.23 VLAN Status

Syntax show vlan [VID]

Context [Admin Exec](#)

Usage Show overview of VLANs or a single VLAN status

7.3.24 Interface Status

Syntax show iface [IFNAME]

Context Admin Exec

Usage Show overview of interfaces or a single interface.

7.3.25 List Configuration and Log Files

Syntax dir [<cfg:// | log:// | usb://>]

Context Admin Exec

Usage List files in the configuration file directory, log file directory, or files on a mounted USB memory. When listing configuration files you should be able to see which of the present configuration files that is used as startup file. To map a different configuration file as startup configuration, see the **"copy"** command (section 7.3.26).

Default values cfg://

 **Example**

```
example:/#> dir
=====
Contents of Config File System
=====
                config0.cfg --> startup-config
                config1.cfg
example:/#>
```

7.3.26 Copy, Store, Restore or Paste Files

Syntax copy <FROM_FILE> <TO_FILE>

Several methods are available to specify <FROM_FILE> and <TO_FILE>. Local file access methods are listed below:

- Configuration files (default): **"cfg://<FILENAME>"**
- Special configuration files: **"console", "running-config", "startup-config",** and **"factory-config"**.
- Log files: **"log://<FILENAME>"**

- USB memory: `"usb://[DIRECTORY/]<FILENAME>"`

Remote file access methods:

- TFTP: `"tftp://location[/directory]/filename"`
- FTP: `"ftp://[username[:password]@]location[:PORT][directory]/filename"`

If no username is provided, anonymous ftp login will be used. Default password is `"guest@default"`.

- SCP: `"scp://[username@]location[:PORT][directory]/filename"`
By default username `"admin"` will be used.
- HTTP: `"http://location[:PORT][directory]/filename"`

Context [Admin Exec](#)

Usage Copy files, save config, transfer to/from network locations. Copy local-to-local, local-to-network and network-to-network. Special files are console, running-config, startup-config and factory-config.

The variant `"copy <FROM> startup-config"`, where `"FROM"` is a file of the form `"configN[.cfg]"` or `"cfg://file.cfg"`, changes which configuration file is used as the startup-config. In effect only changing which file startup-config points to. The contents of the previous file it pointed to remains untouched.

This also means that you can **not** copy a file directly to startup-config from any VFS. I.e., when copying a file from (T)FTP or USB you must first copy the file to a configN[.cfg] file in the cfg:// VFS.

Please note, the use of the special file `"console"` is very similar to the old DOS style usage. Albeit limited to the usage: `"copy console <FILE>"`. When issuing this command you are presented with a *paste area* where you can safely type in or paste parts of, or full, configuration files. However, when pasting in partial ".cfg" file snippets the system will use WeOS defaults for unspecified settings.

Also, the destination file in `"copy console <FILE>"` cannot be the console itself or factory-config, which is read-only. Hence we recommend using: `"copy console config<N>"` or `"copy console running-config"`.

Default values N/A

Examples

1. Restore factory default (to running configuration)

Example

```
example:/#> copy factory-config running-config
Using default factory.cfg found in firmware image.
Stopping Syslog daemon ..... [ OK ]
Starting Syslog daemon ..... [ OK ]
example:/#>
```

2. Store running configuration to startup configuration

Example

```
example:/#> copy running-config startup-config
example:/#>
```

3. Copy configuration file from USB to local configuration file *config3*.

Example

```
example:/#> copy usb://myconfig.cfg config3
Copying myconfig.cfg to config3 ...
Done.
example:/#>
```

4. Copy configuration file onto remote server using FTP.

Example

```
example:/#> copy cfg://config0.cfg ftp://mylogin:mypw@192.168.2.99/myconfig
example:/#>
```

7.3.27 Delete a Configuration File

Syntax `erase [fileys://]<FILENAME>`

fileys can be "cfg", "log", or "usb", with "cfg" as default.

Context Admin Exec

Usage Delete a configuration file, log file or a file on a mounted USB memory.

Default values "cfg" is the default file system.

```

Example
example:/#> dir
=====
Existing Configurations on System
=====
config0 --> startup-config
config1

example:/#> erase config1
example:/#> dir
=====
Existing Configurations on System
=====
config0 --> startup-config

example:/#>
    
```

7.3.28 Show Configuration File (or other files)

Syntax show <running-config|startup-config|factory-config|
[<fileys>://]<FILENAME>

fileys can be "cfg", "log", or "usb", with "cfg" as default.

Context Admin Exec

Usage Show content of a configuration file, log file, or file on a mounted USB memory. Special files are *running-config*, *startup-config* and *factory-config*. Use the "dir" command to list files (section 7.3.25).

Default values "cfg" is the default file system.

7.3.29 Activate Auto-Backup

Syntax backup (applicable on units with USB port)

Context Admin Exec

Usage This command activates WeOS automatic backup and restore for USB media. The directory `"/usb/westermo/backup"` is used for this purpose.

See section 7.1.6 for details.

Default values Not applicable.

7.3.30 Manual Restore from USB

Syntax restore (applicable on units with USB port)

Context Admin Exec

Usage Force restore from USB to running-config.

This command can be used to force an auto-restore of backup files from a USB stick to "**cfg://**" and also activate the new startup-config in the system running-config.

See [section 7.1.6](#) for details.

Default values Not applicable.

7.3.31 Rebooting the Device

Syntax reboot

Context Admin Exec

Usage Reboot the device. The switch will boot up with its *startup-config*.

Default values Not applicable.

7.3.32 Configuration hash

Syntax show hash

Context Admin Exec

Usage Calculates SHA-1 hashes of the running configuration and of the startup configuration.

Default values Not applicable.

Example

```
example:/#> show hash
Running Configuration hash: 0d0388313012d63cc79d20f6b06d9b5fc143aaa6
Startup Configuration hash: f22f7c69d2e46f50f0f5baf987faeb49a588b173
example:/#> cp running startup
example:/#> show hash
Running Configuration hash: 0d0388313012d63cc79d20f6b06d9b5fc143aaa6
Startup Configuration hash: 0d0388313012d63cc79d20f6b06d9b5fc143aaa6
example:/#>
```

7.3.33 Import Certificate/Key

Syntax (for PKCS#12)

```
cert import pkcs [password <PASSWORD>] <URI> [label <LABEL>]
```

Syntax (for PEM)

```
cert import pem type <private|public|ca> <URI> [label <LABEL>]
```

Syntax (for OpenVPN key)

```
cert import ovpn <URI> [label <LABEL>]
```

Context [Admin Exec](#)

Usage Import PKCS#12 certificate bundle, individual certificate files in PEM format, or an OpenVPN static key. An optional label name can be specified. By default the label name is set from the file name.

Examples:

- `"cert import pkcs password "secret" ftp://1.2.3.4/bundle.p12"`
- `"cert import pem type public usb://remote.crt"`
- `"cert import ovpn ftp://1.2.3.4/tls-auth.key label tls"`

To remove/delete a certificate by label, use 'force' to avoid questions:

- `"no cert remote"` (Remove certificate file with label "remote". There can be different certificate files (of different types) with the same label. If so, a separate question will be asked for each file before removal.)
- `"no cert force remote"`

Default values Not applicable.

7.3.34 List and show details of Certificates

Syntax `show cert [LABEL]`

Context [Admin Exec](#)

Usage List all certificates, or show details of a specific certificate.

Example to show all certificates, or display/dump a given label:

- `"show cert"` (lists all certificates)

- **"show cert remote"** (list details of certificate with label "remote". There can be different certificate files (of different types) with the same label. Then all are shown.

Default values Not applicable.

7.3.35 Manage Protocol Licenses

Syntax [no] license <[PROTO]| import <URI>>

Usage Import, delete or list protocol/service license file(s).

When importing a license file, the same type of URLs as for the CLI **"copy"** command can be used (see [section 7.3.26](#)). For example, use **"license import ftp://1.2.3.4/license-file"** to import a licence file with name *license-file* from an FTP server with IP address *1.2.3.4*.

Use **"no license"** to remove all license files, or **"no license PROTO"** to remove a license file for a specific protocol/service. For example, **"no license mrp"** would remove an MRP licensee file if present.

Use **"show license"** to show installed protocol licenses on this product.

Default values Not applicable.

7.3.36 Ping

Syntax ping [iface <IFNAME>] [size <BYTES>] [count <NUM>]
[ttl <NUM>] <HOST>

Context [Admin](#) [Exec](#) context

Usage Ping a remote host.

The ping command runs forever, sending ICMP ECHO_REQUEST packets to all network hosts matching the HOST argument, or NUM packets if the 'count' option is given. By default ping waits 10 seconds before timing out the first packet. However, with the 'count' option that timeout applies to every packet.

The HOST argument can be a unicast IP address, a specific device, a network broadcast address, a multicast group, or a domain name. A valid DNS setup is necessary for resolving domain names, see [section 22.7.5](#).

iface IFNAME This option can be used to select either the interface to send ICMP_ECHO on, which is useful in, e.g., VPN setups. It can also be used to spoof the source IP address.

count NUM The number of ICMP packets to send. For instance, if your terminal software is incapable of sending Ctrl-C.

size BYTES Alters the default size of the ICMP packets. This only only increases the empty payload of the packet.

tll NUM Set the IP Time to Live, (default:64, 1 for multicast)

Note: For multicast the TTL defaults to 1, must be set manually for routing!

Default values Not applicable.

Example

```
example:/#> ping 192.168.131.1
Ctrl-C to abort PING 192.168.131.1 (192.168.131.1): 56 data bytes
64 bytes from 192.168.131.1: seq=0 ttl=64 time=4.832 ms
64 bytes from 192.168.131.1: seq=1 ttl=64 time=0.836 ms
64 bytes from 192.168.131.1: seq=2 ttl=64 time=0.810 ms
64 bytes from 192.168.131.1: seq=3 ttl=64 time=0.823 ms
^C
--- 192.168.131.1 ping statistics ---
4 packets transmitted, 4 packets received, 0% packet loss
round-trip min/avg/max = 0.810/1.825/4.832 ms
example:/#>
```

7.3.37 Traceroute

Syntax traceroute <HOST>

Context Admin Exec context

Usage Trace the path the packets take to a remote host.

Traceroute is useful as a basic diagnostic tool.

You can use the domain name or IP address as the host argument, but you need a valid name server setup for domain names to work, see [section 22.7.5](#).

Default values Not applicable.

Example

```
example:/#> tracert 192.168.130.41
tracert to 192.168.130.41 (192.168.130.41), 30 hops max, 40 byte packets
 1 192.168.131.1  1.116 ms  0.755 ms  0.806 ms
 2 192.168.130.41  0.824 ms  0.705 ms  0.742 ms
example:/#>
```

7.3.38 Remote Login to another device (SSH Client)

Syntax `ssh [USER@]<IPADDR|DOMAINNAME>[/PORT]`

Context `Admin Exec` context.

Usage Login to remote device using SSH.

Default values Default user **"admin"**, default (TCP) port number **"22"**.

7.3.39 Generate, import or export a SSH host key

Syntax `ssh-host-key [generate TYPE [size SIZE]] [import|export TYPE]`

Context `Admin Exec` context.

Usage Generate, import or export a SSH host key.

Use **"show ssh-host-key"** to view current SSH host keys.

Example

```
example:/#> ssh-host-key generate rsa size 2048
rsa host key will be removed, are you sure (y/N)? y
Generating 2048 bit rsa key, this may take a while...
Public key portion is:
ssh-rsa AAAAB3NzaC1yc2EAAAADAQABAAQ7h+u/FChS2vFinUvQhZZeYeaWdek0L1cAlVrQSVSFsKakHQY
...
vjHIMxVia4mHSrKpQ+EMyap2VlbdC9fv admin@example
Fingerprint: sha1!! 59:4b:55:c6:21:19:18:8f:ad:60:16:e3:6f:7a:38:77:5b:52:01:f0
example:/#>
```

7.3.40 Import a SSH user key

Syntax `[no] ssh-user-key [import USER]`

Context `Admin Exec` context.

Usage Import an authorized public key.

Importing the public part of a SSH key pair allows a user to login via SSH without entering a password.

Note: SSH key authentication is currently only supported for user **admin**.

The imported public key must be 'dropbear' compatible. E.g., on Linux, the 'ssh-keygen' command with type 'rsa' or 'dsa' is likely to generate acceptable key pairs.

Use "**show ssh-user-key**" to view current SSH user keys.

Use "**no ssh-user-key [USER]**" to remove existing user keys for the given user (only 'admin' supported).

Example

```
example:/#> ssh-user-key import admin
Paste SSH user key(s) and hit enter twice:
ssh-rsa AAAAB3NzaC1yc2EAAAADAQABAAQ7h+u/FChS2vFinUvQhZZeYeaWdek0L1cAlVrQSVSFsKakHQY
...
Successfully imported SSH user key(s) for admin
example:/#>
```

7.3.41 Remote Login to another device (Telnet Client)

Syntax telnet <IPADDR|DOMAINNAME>[:PORT]

Context Admin Exec context.

Usage Login to remote device using Telnet.

Default values Default (TCP) port number "23".

7.3.42 Show IPConfig Neighbours

Syntax show ipconfig [IFNAME]

Context Admin Exec context.

Usage The command has two purposes:

- Scan the network for IPConfig neighbours on the given interface, i.e., scan for other Westermo devices with the *IPConfig service* enabled (see [section 8.3.31](#)).
- Show status of the IPConfig process on the own device, if enabled.

Note: There is another **"show ipconfig"** command available in the [Global Configuration](#) context, which shows IPConfig *server configuration* settings, see [section 8.3.31](#).

Default values If no interface is given, a scan for IPConfig neighbours is tried on interface *vlan1* (if existing).

 **Example**

```
example:/#> show ipconfig
Using default interface vlan1
MAC                IP                Ver.  Type                Status
=====
00:07:7c:87:85:23  192.168.2.100/24  4.03 Lynx+                -----SI
00:07:7c:87:85:13  192.168.2.200/24  4.03 Lynx+                -----RSI
00:07:7c:87:57:a3  192.168.2.201/24  4.03 Lynx+                FOC:RING:MN:RSI
00:07:7c:87:85:d3  192.168.2.225/24  4.03 Lynx+                MEM:RING:MN:RSI
=====
Process ipconfigd running as PID 475
example:/#>
```

Explanations to the output:

- MAC: The *base* MAC address of the discovered device.
- IP: The IP address of the discovered device.
- Version: Software version on the discovered unit. In the example above, all discovered devices are running some variant of 4.3.x software. The *platform generation* number (4) and *feature release* (03) number are shown, but we cannot determine if those units are running 4.3.0, 4.3.1 or some other 4.3.x patch revision.
- Type: The type of Westermo device discovered.
- Status:
 - If FRNT is enabled, the role is displayed as **"FOC"** (focal point) or **"MEM"** (member switch), and one can also see whether the FRNT ports are up or down: **"M"** - FRNT port M is up, **"m"** - FRNT port M is down, and so on. Note: the ports **"M"** and **"N"** refers to the operational state of the FRNT port, which can differ from their configured role if the ports are connected in the wrong order (swapped).
 - If RSTP/STP is enabled on the discovered device, the letter **"R"** is shown.
 - If SNMP is enabled on the discovered device, the letter **"S"** is shown.

- If IGMP Snooping is enabled on the discovered device, the letter "I" is shown.

7.3.43 Send Wake-On-LAN packet

Syntax wake-on-lan <IFNAME> <MACADDRESS>

Context Admin Exec context.

Usage Send Wake-On-LAN packet on the specified interface to wake a unit with specified MAC address.

Default values Not applicable.

7.3.44 Show System Environment Sensors

Syntax show env

Context Admin Exec context.

Usage List available environment sensors, their index, and their current value. Examples of sensors are *power* (DC1 and DC2), Digital In, and Temperature sensors.

If the unit has a Status Relay, the current status is shown here.

If the unit is equipped with DDM/DOM capable SFPs¹⁶, the voltage, bias current, Tx power, Rx power and temperature parameters will be listed for each SFP.

Default values Not applicable.

7.3.45 Show System Uptime

Syntax show uptime

Context Admin Exec context.

Usage Show system uptime.

Default values Not applicable.

¹⁶DDM/DOM diagnostic information is only available for Westermo DDM SFPs, see the SFP Transceiver Datasheet of your WeOS product (www.westermo.com).

7.3.46 Show Memory Usage

Syntax show memory

Context Admin Exec context.

Usage Show system memory usage.

Default values Not applicable.

7.3.47 Show Running Processes

Syntax show processes

Context Admin Exec context.

Usage Show a list of currently running processes.

Default values Not applicable.

7.3.48 Show Flash Partition Table

Syntax show flash-table

Context Admin Exec context.

Usage Show information on the flash partition table.

Default values Not applicable.

7.3.49 Show Partition table

Syntax show partitions

Context Admin Exec context.

Usage Show information on the flash partition table. The "**show partitions**" is similar to the "**show flash-table**" command ([section 7.3.48](#)), but presents the partition table somewhat differently.

Default values Not applicable.

Examples

- Example with a WeOS unit (Basis platform) with Barebox bootloader and with a primary firmware partition only (see partition *mtd0* and *mtd1*).

Example

```
example:/#> show partitions
Partition Name          Size
-----
mtd0      Barebox           512.0 KiB
mtd1      Linux_main        24.8 MiB
mtd2      Reserved          128.0 KiB
mtd3      Config             6.2 MiB
mtd4      BareboxEnv         256.0 KiB
example:/#>
```

- Example with a WeOS unit (Basis platform) with Barebox bootloader and with primary and secondary firmware partitions (see partition *mtd0*, *mtd1* and *mtd2*).

Example

```
example:/#> show partitions
Partition Name          Size
-----
mtd0      Barebox           512.0 KiB
mtd1      Linux_main        12.5 MiB
mtd2      Linux_backup      12.5 MiB
mtd3      Config            6.2 MiB
mtd4      BareboxEnv        256.0 KiB
example:/#>
```

- Example with a WeOS unit (Basis platform) with RedBoot bootloader (see partition *mtd0*). Note, Barebox is the preferred bootloader.

Example

```
example:/#> show partitions
Partition Name          Size
-----
mtd0      RedBoot           512.0 KiB
mtd1      Linux_main        12.5 MiB
mtd2      Linux_backup      12.5 MiB
mtd3      JFFS2             4.0 MiB
mtd4      Branding           2.1 MiB
mtd5      RedBoot config    4.0 KiB
mtd6      FIS directory     128.0 KiB
example:/#>
```

- Example with WeOS unit (Corazon platform) with Barebox bootloader (see partition *mtd4*).

 **Example**

```
example:/#> show partitions
Partition Name                Size
-----
mtd0      Linux_main             56.0 MiB
mtd1      Linux_backup             56.0 MiB
mtd2      Config                   15.0 MiB
mtd3      BareboxEnv              512.0 KiB
mtd4      Barebox                  512.0 KiB
example:/#>
```

- Example with WeOS unit (Corazon platform) with U-boot bootloader (see partition *mtd4*). Note, Barebox is the preferred bootloader.

 **Example**

```
example:/#> show partitions
Partition Name                Size
-----
mtd0      Linux_main             56.0 MiB
mtd1      Linux_backup             56.0 MiB
mtd2      Config                   15.0 MiB
mtd3      U-Boot Config          512.0 KiB
mtd4      U-Boot                  512.0 KiB
example:/#>
```

Chapter 8

General System Settings

This chapter describes functionality related to the general behaviour of the WeOS unit. In particular it concerns settings for managing the unit, e.g., enabling/disabling the unit's Web server, or controlling remote CLI access by enabling/disabling the SSH or Telnet server.

This chapter also covers settings for the unit's identity, location, time, etc. System *hostname*, *location* and *contact* correspond to the associated system objects of the original MIB-2 standard MIB (RFC 1213). For more information on WeOS SNMP support, see [chapter 6](#).

8.1 Overview of General System Features

Feature	Web	CLI	General Description
<u>System Identity and Time</u>			
System Hostname	X	X	
System Location	X	X	
System Contact	X	X	
System Time Zone	X ¹	X	
System Date/Time	X	X	
<u>Controlling Management Services</u>			
Manage LLDP service	X	X	Section 8.1.1
Manage Web server	X	X	Section 8.1.2

Continued on next page

Continued from previous page			
Feature	Web	CLI	General Description
Manage IPConfig service		X	
Manage SSH server		X	
Manage Telnet server		X	
Manage SNMP server	X	X	(See chapter 6)
<u>Other System settings</u>			
Class of Service (Layer-2 priority)	X	X	Sections 10.1.4 and 15.1.4
CPU bandwidth limitation		X	
System watchdog management		X	Section 8.1.3

[Section 8.2](#) covers management of general system settings via the Web interface, and [section 8.3](#) describes the corresponding features in the CLI.

8.1.1 Managing LLDP

The Link Layer Discovery Protocol (LLDP) is a standardised layer 2 protocol (IEEE 802.1AB[20]), which advertises information about the device itself and its capabilities to other devices within a LAN. The LLDP protocol also advertises from which port the LLDP packet was sent. This enables the unit to build up a local view of the remote ports on neighbour devices it is connected to for each local port. This information is then stored in an SNMP MIB (LLDP MIB[20]), which can be used by NMS-systems to draw a topology map of the network.

Examples of information advertised by LLDP:

- Remote port number
- Port identifier
- Chassis identifier
- Management IP address (see note below)
- Hostname
- MAC-address

¹Web configuration of System Time Zone is done as part of the Network settings, see [section 22.5](#).

- VLAN ID
- Organizationally specific TLV (see note below)

LLDP can be enabled/disabled globally as well as on a per port basis. As of WeOS v4.33.0, LLDP support is limited to *RxTx* and *Disabled* modes, i.e., when enabling LLDP on a port it is set both for transmission and reception LLDP frames.

In WeOS, LLDP frames are by default advertised every 30 second. In WeOS this *TxInterval* is configurable in range 1-300 seconds.

 **Note**
LLDP in WeOS is implemented inline with the 2005 version of LLDP[20]). As the standard specifies 5 seconds as the lower limit for *TxInterval*, the **recommended** range for *TxInterval* on WeOS units is 5-300 seconds even if it can be set as low as 1 second.

If an interface stops receiving LLDP frames from a specific neighbour, the neighbour information will expire. Each LLDP message holds a time-to-live (TTL) value specifying how long it is valid; the TTL is calculated as $TxHold * TxInterval$, which defaults to 120 seconds (4*30) on WeOS units.

Information on some specific LLDP TLVs advertised by WeOS units.

- **Management IP address:** The advertised IP address is an address of the ports default VLAN, see [section 15.1.2](#).
- **Organizationally Specific TLVs:** It is possible to configure organizationally specific TLVs (Type 127), referred to as custom TLVs in this document. When configuring a custom TLV, the *vendor code* (OUI) and *sub-type* need to be specified along with the information (value) field of the TLV.

8.1.2 Managing Web Server

In WeOS the Web server runs the Web GUI. Configurable Web server settings are:

- **Session Timeout:** A user logging in via the Web GUI will automatically be logged out if inactive for this period of time. The timeout can be disabled. Default: **10 min**
- **HTTP port:** The TCP port the Web Server listens to for HTTP. Default: **80**

- **HTTPS port:** The TCP port the Web Server listens to for HTTPS.
Default: **443**
- **Custom HTTPS certificate:** A unique self-signed HTTPS certificate will be generated for the Web server unless a custom certificate is used. You may upload your custom certificate (see [section 7.1.8](#)) and apply it to the Web server using the *Custom HTTPS certificate* setting, see [section 8.2.4](#) (Web) and [8.3.30](#) (CLI).
Default: **Disabled** (i.e., use generated certificate)

8.1.3 Managing System Watchdog

The system watchdog handles unexpected failure modes and CPU overload scenarios. The watchdog service periodically “kicks” the watchdog timer (WDT) circuitry, preventing it from timing out and resetting the unit.

By default, the watchdog *kick interval* is set to 20 seconds, and the watchdog *timeout delay* to 60 seconds. These settings can be tweaked, e.g. increase the timeout, for systems with expected sustained network load. It is however not advised to reduce the timeout or kick interval below the default settings.

The unit registers a few useful data points relating to resets.

- **Reset Counter** The unit registers the number of times it has been (re)booted, referred to as the *reset counter* ¹.
- **Reset Cause** The unit registers what caused the (re)boot, referred to as the *reset cause* which can be either `WDIO_CARDRESET` or `WDIO_POWERUNDER`, indicating a watchdog timeout or a power failure respectively.
- **Reset Reason** It also registers why the unit was reset. In the case of `WDIO_CARDRESET` this could be a user triggered *reboot* or an *unknown* reason, which could typically mean system overload.
For the cause `WDIO_POWERUNDER`, reset reason is always unknown.

These data points can be inspected in the CLI ([section 8.3.25](#)). The number of resets indicated by the *reset counter* can be inspected in the Web([section 4.4.2](#)). The *reset counter* is incremented on every boot, unless the watchdog service itself is disabled. The counter can only be cleared with a factory reset.

¹This reset counter is also used for the “snmp engine boot counter” (oid *snmpengineboots* in the snmp framework mib).



Note

Although not recommended from a system robustness perspective, it is possible to disable the watchdog daemon. This only disables the system service and the *reset counter* logic, the WDT itself and a basic driver is still active to handle unexpected failure modes.

8.2 Managing General System Settings via the web interface

Menu path: Configuration ⇒ System ⇒ Identity

Fig 8.1 shows the page where you can set hostname, location and contact information for your switch.

Figure 8.1: Switch identity settings example

Hostname	A name to identify this unit. Max 64 characters. Valid characters are A-Z, a-z, 0-9, and hyphen (-). The first character should be alphabetic (A-Z, a-z). Hyphen is not valid as first or last character.
Location	A description to identify where the unit is located. Max 64 characters. Valid characters are ASCII 32-126. "Space" (ASCII 32) is not valid as first or last character.
Contact	A description identifying whom to contact regarding management of the unit. Max 64 characters. Valid characters are ASCII 32-126. "Space" (ASCII 32) is not valid as first or last character.

Change the values to appropriate values for your switch and click the **Apply** button.

8.2.1 Set System Date and Time

Menu path: Configuration ⇒ System ⇒ Date & Time

Date & Time

The screenshot displays the 'Date & Time' configuration window. At the top, the 'Time Zone' is set to 'Etc/UTC'. The 'Current date/time' is shown as '2020-12-02 21:49:15' with a pencil icon for manual editing. Under 'Remote NTP Server', the 'Enabled' checkbox is checked. The 'Address' field contains 'pool.ntp.org' and has its own 'Enabled' checkbox checked. The 'Poll Intervall' is set to '600' seconds. A trash icon and a plus sign are visible next to the poll interval field. The 'Local NTP Server' checkbox is unchecked. At the bottom, there are three buttons: 'Apply', 'Cancel', and 'Trigger NTP Sync'.

Figure 8.2: Switch date and time settings, NTP client/server

Timezone	Select a timezone region to get adjusted local time.
Current Date/Time	Shows current date and time. Click the  icon to manually set date/time.
Remote NTP Server	The IP address of a time server to be used to keep the units calendar time synchronised. Leave empty if you do not want to use a time server, or if NTP server should be acquired via DHCP or PPP.
Local NTP Server	Check if the unit should to serve as NTP server toward NTP clients. It is expected that the unit itself gets it time from a remote (higher level) NTP server, see the Remote NTP Server setting above.

**Note**

When setting the timezone using 'Etc/GMT+/-offset', please take into account that the system is consistent with POSIX, which has positive signs west of Greenwich, while many people expect positive signs east of Greenwich.



For example, 'Etc/GMT+4' corresponds to 4 hours behind UT (i.e. west of Greenwich) even though many people would expect it to mean 4 hours ahead of UT (i.e. east of Greenwich).

8.2.2 Enable/disable LLDP via the web interface

Menu path: Configuration ⇒ LLDP

LLDP

Enabled	Tx Interval	Tx Hold Multiplier	Ports	
✓	30	4	ALL	 

 Edit	Click this icon to edit LLDP settings
 Remove	Click this icon to disable LLDP and remove LLDP settings.

Menu path: Configuration ⇒ LLDP ⇒ 

LLDP

Enabled



Tx Interval

Tx Hold Multiplier

Port

1	2	3	4	5	6
<input checked="" type="checkbox"/>	<input checked="" type="checkbox"/>	<input checked="" type="checkbox"/>	<input checked="" type="checkbox"/>	<input checked="" type="checkbox"/>	<input checked="" type="checkbox"/>

Enabled	Check this box to enable/disable LLDP on the unit.
Tx Interval	Set the interval between LLDP advertisement packets.
Continued on next page	

Continued from previous page	
Tx Hold Multiplier	Set how many times the <i>Tx Interval</i> should be multiplied to calculate the TTL in the LLDP packet.
Ports (Multiple fields)	Check the Enable box to enable/disable LLDP on a specific port. In the Custom TLV drop-down menu(s), select custom TLV (max three) to be sent out on this port. The TLVs must be created before appearing in the menus.
Custom TLV (Multiple fields)	Add a custom TLV by clicking the  icon. Use the  icon to remove the custom TLV. Id , OUI and Subtype are mandatory. Value can be entered as ASCII string or hexadecimal sequence. Check the Hex box to enter Value as hexadecimal sequence.

8.2.3 Show LLDP Status via the web interface

Menu path: Status ⇒ LLDP

LLDP Status

```
-----  
LLDP neighbors:  
-----  
Interface:   Eth 2/5, via: LLDP, RID: 1, Time: 0 day, 00:09:16  
Chassis:  
  ChassisID:  mac 00:07:7c:02:0e:60  
  SysName:    dut  
  SysDescr:   Lynx WeOS v4.12.x  
  MgmtIP:     192.168.2.230  
  Capability: Bridge, on  
  Capability: Router, on  
Port:  
  PortID:     mac 00:07:7c:02:0e:63  
  PortDescr:  10/100TX Eth 3  
VLAN:       1 vlan1  
LLDP-MED:  
  Device Type: Network Connectivity Device  
  Capability:  Capabilities  
  Capability:  Policy  
  Capability:  Location  
  Capability:  MDI/PSE  
  Capability:  MDI/PD  
  Capability:  Inventory  
-----
```

Auto refresh: Off, [5s](#), [15s](#), [30s](#), [60s](#)

Refresh

8.2.4 Manage Web server configuration

Menu path: Configuration ⇒ System ⇒ Web

Fig 8.3 shows the page where you can change session timeout, HTTP port, HTTPS port and custom HTTPS certificate for the Web server of your switch.

Figure 8.3: Web interface settings example

Session Timeout	Change the session timeout value. Default 10 min.
HTTP Port	Change HTTP port. Default 80.
HTTPS Port	Change HTTPS port. Default 443.
Custom certificate	Select a custom HTTPS certificate. The certificate must have been previously imported (as described in section Section 7.2.5.1).

8.2.5 Class of Service (CoS)

Menu path: Configuration ⇒ System ⇒ Class of Service

Fig 8.4 shows the page where you can change the mapping between PCP/DSCP priority and hardware queues.

CoS (Class of Service)

PCP Priority Mapping

Priority

Queue Default Custom

0	0,1
1	2,3
2	4,5
3	6,7

DSCP Priority Mapping

Priority

Queue Default Custom

0	0-15
1	16-33
2	34-45,47
3	46,48-63

Figure 8.4: Class of Service settings example

Default	Use the default priority mapping.
Custom	Use a custom priority mapping (0-7 for PCP priority, 0-63 for DSCP priority).
Queue	Priority queue of outbound ports (0-3).

8.3 Managing General System Settings via CLI

Command	Default	Section
<u>Configure General System Settings</u>		
system		Section 8.3.1
[no] hostname <ID>	"family" ¹	Section 8.3.2
[no] location <ID>	(empty)	Section 8.3.3
[no] contact <ID>	(empty)	Section 8.3.4
[no] timezone <TIMEZONE>	Etc/UTC	Section 8.3.5
[no] cpu-bandwidth-limit <auto <64-100000> <7700-1488000> fps>	Auto	Section 8.3.6
<u>Set date and time</u>		
date		Section 8.3.7
[no] ntp (<i>and related settings</i>)	Disabled	Section 22.7
<u>View available time zones</u>		
system		
show timezone [QUERY SUBSTRING]		Section 8.3.8
<u>LLDP Management</u>		
[no] lldp	Enabled	Section 8.3.9
[no] enable	Enabled	Section 8.3.10
[no] tx-interval <SEC>	30	Section 8.3.11
[no] tx-hold-multiplier <VALUE>	4	Section 8.3.12
[no] port <PORTLIST all>		Section 8.3.13
[no] enable	Enabled ²	Section 8.3.14
[no] custom-tlv <ID>		Section 8.3.15
[no] custom-tlv <ID>		Section 8.3.16
[no] oui <OUI>		Section 8.3.17
[no] subtype <0-255>	0	Section 8.3.18
[no] value <string hex> <VALUE>	(empty)	Section 8.3.19
<u>Show LLDP status</u>		
show lldp		Section 8.3.20

Continued on next page

Continued from previous page		
Command	Default	Section
<u>Watchdog Management</u>		
watchdog		Section 8.3.21
[no] enable	Enabled	Section 8.3.22
[no] interval <SEC>	20	Section 8.3.23
[no] timeout <SEC>	60	Section 8.3.24
 <u>Show Watchdog status</u>		
show watchdog		Section 8.3.25
 <u>Configure Management Service Settings</u>		
[no] web	Enabled	Section 8.3.26
[no] session-timeout <TIMEOUT>	10 Min	Section 8.3.27
[no] port <PORT>	80	Section 8.3.28
[no] ssl-port <PORT>	443	Section 8.3.29
[no] certificate <LABEL>		Section 8.3.30
[no] ipconfig	Enabled	Section 8.3.31
[no] read-only	Disabled	Section 8.3.32
[no] ssh	Enabled	Section 8.3.33
[no] telnet	Disabled	Section 8.3.34
[no] snmp-server	Enabled	Section 6.3.1
 <u>Configure Class of Service Settings</u>		
[no] cos		Section 8.3.35
[no] pcp-priority		Section 8.3.36
[no] dscp-priority		Section 8.3.37

8.3.1 Manage System Identity Information

Syntax system

Context [Global Configuration](#) context

¹The default hostname depends on the product family, e.g., Lynx products have default hostname *lynx*.

²LLDP is enabled on all LAN ports by default, except for xDSL ports.

Usage Enter General System Configuration context.

Use **"show system"** to show all general system configuration settings (also available as **"show"** command within the General System Configuration).

Default values Not applicable

8.3.2 System Hostname

Syntax hostname <STRING>

Context [General System Configuration](#) context

Usage Set system hostname string.

Max 64 characters. Valid characters are A-Z, a-z, 0-9, and hyphen (-). The first character should be alphabetic (A-Z, a-z). Hyphen is not valid as first or last character.

"no hostname" resets the hostname to its default value.

Use **"show hostname"** to view the configured hostname setting.

Default values *"family"* (The default hostname depends on the product family, e.g., Lynx products have default hostname *lynx*.)

8.3.3 System Location

Syntax location <STRING>

Context [General System Configuration](#) context

Usage Set system location string.

Max 64 characters. Valid characters are ASCII 32-126. "Space" (ASCII 32) is not valid as first or last character.

"no location" resets the location string to its default value (empty).

Use **"show location"** to view the configured location setting.

Default values (empty)

8.3.4 System Contact

Syntax contact <STRING>

Context [General System Configuration](#) context

Usage Set system contact string.

Max 64 characters. Valid characters are ASCII 32-126. "Space" (ASCII 32) is not valid as first or last character.

"no contact" resets the contact string to its default value (empty).

Use "show contact" to view the configured contact setting.

Default values (empty)

8.3.5 Set System Time Zone

Syntax [no] timezone <TIMEZONE>

Context [General System Configuration](#) context.

Usage Set system time zone string.

Use "timezone TIMEZONE", e.g., "timezone Asia/Tokyo" to set the time-zone.



Note

For information on available time zone strings, see [section 8.3.8](#).

When setting the timezone using the 'Etc/GMT+/-offset' notation, please take into account that the system is consistent with POSIX which has positive signs west of Greenwich, while many people expect positive signs east of Greenwich.

For example, 'Etc/GMT+4' corresponds to 4 hours behind UT (i.e. west of Greenwich) even though many people would expect it to mean 4 hours ahead of UT (i.e. east of Greenwich).

"no timezone" resets the timezone to its default value (Etc/UTC).

Use "show timezone" to view the configured timezone setting.

Default values Etc/UTC



Example

```
example:/#> date
Thu Nov 11 19:56:27 UTC 2021
example:/#> configure
example:/config/#> system
```

```
example:/config/system/#> timezone Asia/Tokyo
example:/config/system/#> leave
example:/#> date
Fri Nov 12 05:03:26 JST 2021
example:/#>
```

8.3.6 CPU bandwidth limitation

Syntax [no] `cpu-bandwidth-limit` <auto | <64-1000000> | <7700-1488000> fps>

Context [General System Configuration](#) context

Usage Limit the traffic sent to the CPU in kbit/s or frames per second (traffic from the CPU is not affected). It is also possible use ISO modifiers k/M/G, e.g., 256k or 10M as specifiers for kbps and Mbps.

Set values are rounded off to the nearest possible HW setting.

Note

Default is **"auto"**, which means that system will automatically reduce CPU bandwidth when critical services are enabled. As of WeOS v4.33.0, FRNTv0 Ring Coupling or Multi-link Dual-Homing (see [chapter 17](#)), and MRP ([chapter 19](#)) are considered critical, but the set of critical services may change in future WeOS releases.

A user can override the default with **"no cpu-bandwidth-limit"** or any more specific setting (e.g., **"cpu-bandwidth 4M"**). However, for critical services it is recommended leave the default **"auto"**.

On units with multiple CPU channels (see [section 15.1.6](#)), the setting will apply for each of the channels..

Use **"no cpu-bandwidth-limit"** to disable CPU bandwidth limitation.

Use **"show cpu-bandwidth-limit"** to view the configured CPU bandwidth limit setting.

Default values Auto (**"cpu-bandwidth-limit auto"**)

8.3.7 Set or show System Date and Time

Syntax `date` [[YYYY-MM-DD]hh:mm[:ss]]

Context [Admin Exec](#) context.

Usage Set system date and time, or only time.

Use **"show date"** to view the current date and time.

Default values If no date or time is given, the current date and time will be displayed.

Example

```
example:/#> date 2013-05-31 10:18
Fri May 31 10:18:00 UTC 2013
example:/#> show date
Fri May 31 10:18:09 UTC 2013
example:/#>
```

8.3.8 Show System Time Zone

Syntax show timezone [QUERY|SUBSTRING]

Context [General System Configuration](#) context.

Usage Show system time zone setting/list available time zones.

When given without any argument (**"show timezone"**), the configured time zone setting is presented.

When providing an argument, the available time zone settings matching that argument is listed, e.g., issuing the command **"show timezone asia"** will list all possible time zone configuration settings for Asia (or more precisely, all available time zones containing the substring 'asia'.) See [section 8.3.5](#) for information of how to set the system time zone.

Default values Not applicable.

Example

```
example:/#> configure
example:/config/#> system
example:/config/system/#> show timezone
Etc/UTC
example:/config/system/#> show timezone new
America/New_York
America/North_Dakota/New_Salem
Canada/Newfoundland
example:/config/system/#> timezone America/New_York
example:/config/system/#> leave
```

```
example:/#> date
Thu Nov 11 15:11:54 EST 2021
example:/#>
```

8.3.9 Manage LLDP settings

Syntax [no] lldp

Context [Global Configuration](#) context.

Usage Enter LLDP Configuration context. Use command **"lldp"** to enter the LLDP Configuration context. The LLDP Configuration context is created if it does not exist.

Use command **"no lldp"** to disable LLDP and remove all configuration.

Use command **"show lldp"** to view the current configuration. Alternatively, you can enter the LLDP Configuration context and run **"show"** (see example in [section 8.3.10](#)).

Default values LLDP is enabled by default.

8.3.10 Activate/deactivate LLDP

Syntax [no] enable

Context [LLDP Configuration](#) context.

Usage Activate/deactivate LLDP. Use **"enable"** to activate and **"no enable"** to deactivate LLDP configuration. When deactivated, LLDP is disabled, but the configuration is not removed.

Default values Enabled (i.e., activated)

Example

```
example:/config/#> lldp
example:/config/lldp/#> enable
example:/config/lldp/#> show
Status: Enabled
tx-multiplier: 4 (DEFAULT)
tx-interval: 30 sec (DEFAULT)

Per port:
Eth 1 enabled
Eth 2 enabled
Eth 3 enabled
Eth 4 enabled
```

```
Eth 5 enabled  
Eth 6 enabled  
Eth 7 enabled  
Eth 8 enabled  
Eth 9 enabled  
Eth 10 enabled  
example:/config/lldp/#>
```

8.3.11 LLDP Transmission Interval

Syntax [no] tx-interval <1-300>

Context [LLDP Configuration](#) context.

Usage Tx-interval controls how often an LLDP packet will be sent out to its neighbours, e.g., "**tx-interval 10**" sets the interval to 10 seconds.

Note

Although it is possible to configure the Tx-interval as low as 1 second, the recommended range is 5-300 seconds, see [section 8.1.1](#).

Use "**no tx-interval**" to reset the Tx-interval to default.

Use "**show tx-interval**" to show the current Tx-interval setting.

Default values 30 (seconds)

8.3.12 LLDP Transmission Hold Multiplier

Syntax [no] tx-multiplier <2-10>

Context [LLDP Configuration](#) context.

Usage Tx-multiplier controls how many times the Tx-interval should be multiplied to calculate the TTL in the LLDP packet, e.g., setting "**tx-multiplier 3**" and "**tx-interval 5**" implies that transmitted LLDP packets carry a TTL of 15 (seconds).

Use "**no tx-multiplier**" to reset the Tx-multiplier to default.

Use "**show tx-multiplier**" to show the current Tx-multiplier setting.

Default values 4

8.3.13 Manage LLDP per port settings

Syntax [no] port <PORTLIST|all>

Context [LLDP Configuration](#) context.

Usage Enter LLDP Port Configuration context for a port or a set of ports.

Use **"port <PORTLIST>"** to enter LLDP Port Configuration for one or more ports, or **"port all"** to enter LLDP Port Configuration for all (LAN) ports.

As of WeOS v4.33.0 you can use **"no port <PORTLIST>"** and **"no port all"** to disable LLDP on some or all ports. This behaviour may change in future versions of WeOS. To disable LLDP on a port it is therefore recommended to use the **"no enable"** command within the LLDP Port Configuration context, see [section 8.3.14](#).

Default values Not applicable.

8.3.14 Enable/disable LLDP per port

Syntax [no] enable

Context [LLDP Port Configuration](#) context.

Usage Enable/disable LLDP per port. Use **"enable"** to enable LLDP on the port, and **"no enable"** to disable LLDP for the port.

As of WeOS v4.33.0 Rx and tx mode can not be set individually. A port can either be enabled (enables both rx and tx) or disabled. If LLDP is deactivated globally and later activated again (see [section 8.3.10](#)) the per port settings will be remembered.

Default values Enabled (LLDP is enabled on all LAN ports by default. The exception is xDSL ports, where LLDP is disabled by default.)

8.3.15 Map/include custom TLV in port LLDP messages

Syntax [no] custom-tlv <ID>[,ID]

Context [LLDP Port Configuration](#) context.

Usage Map (or remove) one or more custom TLVs to be sent out in the LLDP messages for this port. Up to 3 custom TLVs can be mapped to one port. The same custom TLV can be mapped to several ports.

See [section 8.3.16](#) for how to create and manage custom TLVs.

Use `"custom-tlv <ID>"` to map a specific custom TLV to this port.

Use `"no custom-tlv <ID>"` to remove a specific custom TLV from this port, or `"no custom-tlv"` to remove all custom TLVs configured for this port.

Use `"show custom-tlv"` to show the current setting.

Default values Not applicable.

8.3.16 Manage custom TLV

Syntax [no] custom-tlv <ID>

Context [LLDP Configuration](#) context.

Usage Enter LLDP Custom TLV Configuration context for an existing custom TLV instance, or create the custom TLV instance if it does not exist.

Note

The LLDP Custom TLV Configuration context is where you can configure the content of your custom TLV(s). To include a custom TLV in the LLDP messages sent on one or more ports, you must also map the custom TLV to those ports, see [section 8.3.15](#).

Use `"no custom-tlv <ID>"` to remove a specific custom TLV instance, or `"custom-tlv"` to remove all instances.

Use `"show custom-tlv <ID>"` to list configuration settings for a specific custom TLV (also available as `"show"` command within the LLDP Custom TLV Configuration context).

Default values Not applicable.

8.3.17 Set custom TLV vendor code (OUI)

Syntax [no] oui <OUI>

Context [LLDP Custom TLV Configuration](#) context.

Usage Configure the vendor code (OUI) field of this custom TLV.

Use for example `"oui 01:23:45"` (or `"oui 012345"`) to set the value of the OUI field to `"012345"` (hex).

Configuring the vendor code for the TLV is mandatory, otherwise the setting is not valid. By default the vendor code is not set.

Use **"no oui"** to reset the value to default, and use **"show oui"** to show the current setting.

Default values Not applicable (Not set)

8.3.18 Set custom TLV subtype value

Syntax [no] subtype <0-255>

Context [LLDP Custom TLV Configuration](#) context.

Usage Configure the subtype field of this custom TLV.

Use for example **"subtype 5"** to set the value of the subtype field to **"5"**.

Use **"no subtype"** to reset the value to default, and use **"show subtype"** to show the current setting.

Default values 0

8.3.19 Set custom TLV value

Syntax [no] value <string|hex> <VALUE>

Context [LLDP Custom TLV Configuration](#) context.

Usage Configure the value field of this custom TLV.

The value can be configured in two ways:

- As a *string* when the value consists of the corresponding ASCII values. For example, **"value string coffee"** will be sent as *63 66 66 66 65 65*.
- As a *hexadecimal* sequence, matching the value to be sent. For example, **"value hex c0:ff:ee"** (or **"value hex c0ffee"**) will be sent as *c0 ff ee*.

Use **"no value"** to skip the value field (zero length). This is the default.

"show subtype" to show the current setting.

Default values Not applicable (empty)

8.3.20 Show LLDP Status

Syntax `show lldp`

Context `Admin Exec` context.

Usage Show LLDP information about neighbouring devices.

Default values Not applicable.

 **Example**

```
example:/#> show lldp
-----
LLDP neighbors:
-----
Interface:   Eth 10, via: LLDP, RID: 1, Time: 0 day, 01:32:31
Chassis:
  ChassisID:  mac 00:07:7c:84:d7:44
  SysName:    wolverine
  SysDescr:   Wolverine WeOS v4.9.x
  MgmtIP:     192.168.2.2
  Capability: Bridge, off
  Capability: Router, on
  Capability: Wlan, off
Port:
  PortID:     mac 00:07:7c:84:d7:47
  PortDescr:  10/100TX Eth 2/1
VLAN:        1 vlan1
LLDP-MED:
  Device Type: Network Connectivity Device
  Capability:  Capabilities
  Capability:  Policy
  Capability:  Location
  Capability:  MDI/PSE
  Capability:  MDI/PD
  Capability:  Inventory
-----
```

8.3.21 Manage Watchdog settings

Syntax `[no] watchdog`

Context `Global Configuration` context.

Usage Enter Watchdog Configuration context. Use command **"watchdog"** to enter the Watchdog Configuration context.

Use command **"no watchdog"** to reset all Watchdog daemon settings to default.

Use command **"show watchdog"** to view the current configuration. Alternatively, you can enter the Watchdog Configuration context and run **"show"**.

Default values The watchdog daemon is enabled.

Example

```
example:/#> configure
example:/config/#> watchdog
example:/config/watchdog/#> show
Status          : Enabled
Kick interval   : 20 sec
WDT Timeout     : 60 sec
example:/config/watchdog/#>
```

8.3.22 Activate/deactivate Watchdog daemon

Syntax [no] enable

Context [Watchdog Configuration](#) context.

Usage Activate/deactivate system watchdog daemon. Use **"enable"** to activate and **"no enable"** to deactivate the watchdog daemon. When deactivated, the watchdog daemon is disabled, but the configuration is not removed.

Default values Enabled (i.e., activated)

8.3.23 Set watchdog kick interval

Syntax [no] interval <1-128>

Context [Watchdog Configuration](#) context.

Usage Configure the watchdog kick interval in seconds.

This is the time between kicks from watchdog daemon to the kernel watchdog driver. Recommended to set to 1/3 of the kernel watchdog timeout, see [section 8.3.24](#)

"interval 10" will set the kick interval to 10 seconds. Use **"no interval"** to reset the interval to default (20).

Use **"show interval"** to show the current setting.

Default values 20 (seconds)

8.3.24 Set watchdog timeout

Syntax [no] timeout <1-128>

Context [Watchdog Configuration](#) context.

Usage Configure the watchdog kernel timeout in seconds.

This is the timeout before the kernel watchdog timer elapses. Recommended to set to ≥ 10 seconds.

"**timeout 30**" will set the timeout to 30 seconds. Use "**no timeout**" to reset the timeout to default (60).

Use "**show timeout**" to show the current setting.

Default values 60 (seconds)

8.3.25 Show Watchdog Status

Syntax show watchdog

Context [Admin Exec](#) context.

Usage Show watchdog status information.

Default values Not applicable.

Example

```
example:/#> show watchdog
Reset counter   : 6
Reset cause    : WDIOF_CARDRESET
Reset reason   : reboot
Timeout (sec)  : 60
Kick interval  : 20
example:/#>
```

8.3.26 Enable/disable Web Management Interface

Syntax [no] web

Context [Global Configuration](#) context.

Usage Enable Web management interface, and enter Web Configuration context. Use "**no web**" to disable the Web server.

**Warning**

| Then the switch cannot be managed via the Web interface.

Use **"show web"** to list current Web configuration settings (also available as **"show"** command within the Web Configuration context).

Default values Enabled ("**web**")

8.3.27 Set Web Server Session Timeout

Syntax [no] session-timeout <1-1440>

Context [Web Configuration](#) context.

Usage Configures the Web server session timeout in minutes. Use **"session-timeout <TIMEOUT>"** to set the timeout, e.g., **"session-timeout 5"** to set the timeout to 5 minutes.

"no session-timeout" disables the session timeout.

"show session-timeout" shows the current timeout setting.

Default values 10 (minutes)

8.3.28 Set Web Server HTTP port

Syntax [no] port <PORT>

Context [Web Configuration](#) context.

Usage Configures the HTTP port for the Web server, e.g., **"port 8080"** makes the Web server use listen to HTTP on port 8080.

"no port" disables HTTP service on the Web server.

"show port" shows the current HTTP port setting.

Default values 80

8.3.29 Set Web Server HTTPS port

Syntax [no] ssl-port <PORT>

Context [Web Configuration](#) context.

Usage Configures the HTTPS (SSL) port for the Web server, e.g., **"ssl-port 4343"** makes the Web server listen to HTTPS on port 4343.

"no ssl-port" disables HTTPS service on the Web server.

"show ssl-port" shows the current HTTPS port setting.

Default values 443

8.3.30 Set custom Web Server HTTPS certificate

Syntax [no] certificate <LABEL>

Context [Web Configuration](#) context.

Usage Configures a custom HTTPS certificate (has to be uploaded first). If no certificate is chosen the default is to use a self-signed certificate which will be uniquely generated by the device.

"certificate custom1" selects the HTTPS certificate with label **"custom1"** (must have been previously imported, see [section 7.3.33](#)).

"no certificate" resets the HTTPS certificate to the default, an automatically generated certificate.

 **Example**

```
example:/#> show cert
Type      Label      Common Name      Expires
=====
Pub       custom1    device.example.com  Apr 19 2017 GMT
Key       custom1
example:/#> configure
example:/config/#> web
example:/config/web#> certificate custom1
example:/config/web#> leave
```

Default values Disabled (use generated self-signed certificate)

8.3.31 Enable/disable IPConfig Service

Syntax [no] ipconfig

Context [Global Configuration](#) context.

Usage Enable IPConfig service interface (management of the unit via the Westermo IPConfig protocol), and enter IPConfig Configuration context. Use **"no ipconfig"** to disable the IPConfig server



Warning

After this the switch cannot be managed (or detected) via the IPConfig protocol, used by the WeConfig tool.

Use **"show ipconfig"** to list whether IPConfig is enabled or disabled. **Note:** There is another **"show ipconfig"** command available in the [Admin Exec](#) context, which is used (1) to scan for neighbour Westermo units, and (2) to list *status* information on the IPConfig server running on this device, see [section 7.3.42](#).

Default values Enabled (**"ipconfig"**)

Examples

1. How to check whether IPConfig service is enabled on my switch:



Example

```
example:/#> config
example:/config/#> show ipconfig
Ipconfig is enabled
Read only mode : Disabled
example:/config/#> end
```

2. How to enable/disable IPConfig service:

Enter Global Configuration context, check the current IPConfig configuration, and modify it if desired. Below is an example of how to disable IPConfig.



Example

```
example:/#> config
example:/config/#> show ipconfig
Ipconfig is enabled
Read only mode : Disabled
example:/config/#> no ipconfig
Deactivating ipconfig service.
example:/config/#> end
```

8.3.32 Enable/Disable configuration via IPConfig service

Syntax [no] read-only

Context IPConfig Configuration context.

Usage The IPConfig service (used by the WeConfig tool) can be used to discover and view status of a unit, but also for some simple configuration (IP address, netmask and default gateway). By setting IPConfig in **"read-only"** mode, no configuration is possible via IPConfig service.

Use **"show read-only"** to list whether 'read-only' is enabled or disabled. Use **"read-only"** to activate 'read-only' mode, and **"no read-only"** to set the mode to 'read/write'.

Default values Enabled (**"read-only"**, i.e., configuration via IPconfig service is not possible.)

Examples How to limit IPConfig service to 'read-only'. That is, disabling configuration of the unit via IPConfig, while allowing use of IPConfig to discover the unit and status information retrieval.

Example

```
example:/#> config
example:/config/#> show ipconfig
Ipconfig is enabled
Read only mode : Disabled
example:/config/ipconfig/#> read-only
Setting IPconfig read only mode Enabled
example:/config/ipconfig/#> end
```

8.3.33 Enable/disable SSH Service

Syntax [no] ssh

Context Global Configuration context.

Usage Enable SSHv2 management service, and enter SSH Configuration context. Use **"no ssh"** to disable the SSHv2 server.

Warning

| Then the switch cannot be managed via SSHv2.

Use **"show ssh"** to list current SSH configuration settings (also available as **"show"** command within the SSH Configuration context).

Default values Enabled ("**ssh**")

8.3.34 Enable/disable Telnet Service

Syntax [no] telnet

Context [Global Configuration](#) context.

Usage Enable Telnet management service, and enter Telnet Configuration context. Use **"no telnet"** to disable the Telnet server.



Warning

| Then the switch cannot be managed via Telnet.

Use **"show telnet"** to list current Telnet configuration settings (also available as **"show"** command within the Telnet Configuration context).

Default values Disabled ("**no telnet**")

8.3.35 Class of Service (CoS) mapping

Syntax [no] cos

Context [Global Configuration](#) context.

Usage Enter [Class of Service Configuration](#) context.

Use **"no cos"** to reset the PCP and DSCP priority mappings to the default values.

Use **"show cos"** to list the current priority maps.

Default values See [Table 10.2](#) and [Table 10.3](#)

8.3.36 PCP priority map

Syntax [no] pcp-priority <PRIO_LIST> queue <QUEUE_NB>

Context [Class of Service Configuration](#) context.

Usage Configures the PCP priority (0-7) to hardware queue mapping (0-3).

Use **"no pcp-priority"** to reset the PCP priority mapping to the default values.

Use **"show pcp-priority"** to show the current mapping.

Default values See [Table 10.2](#)

Example when moving PCP priority 6 from queue 3 (highest) to queue 2 (next-highest).

Example

```
example:/config/cos/#> show pcp-priority
pcp-priority 0,1 queue 0
pcp-priority 2,3 queue 1
pcp-priority 4,5 queue 2
pcp-priority 6,7 queue 3
example:/config/cos/#> pcp-priority 6 queue 2
example:/config/cos/#> show pcp-priority
pcp-priority 0,1 queue 0
pcp-priority 2,3 queue 1
pcp-priority 4-6 queue 2
pcp-priority 7 queue 3
example:/config/cos/#>
```

8.3.37 DSCP priority map

Syntax [no] dscp-priority <PRIO_LIST> queue <QUEUE_NB>

Context [Class of Service Configuration](#) context.

Usage Configures the DSCP priority (0-63) to hardware queue mapping (0-3).

Use **"no dscp-priority"** to reset the DSCP mapping to the default values.

Use **"show dscp-priority"** to show the current mapping.

Default values See [Table 10.3](#)

Example when moving DSCP priority 48-55 from queue 3 (highest) to queue 2 (next-highest).

Example

```
example:/config/cos/#> show dscp-priority
dscp-priority 0-15 queue 0
dscp-priority 16-31 queue 1
```

```
dscp-priority 32-47 queue 2
dscp-priority 48-63 queue 3
example:/config/cos/#> dscp-priority 48-55 queue 2
example:/config/cos/#> show dscp-priority
dscp-priority 0-15 queue 0
dscp-priority 16-31 queue 1
dscp-priority 32-55 queue 2
dscp-priority 56-63 queue 3
example:/config/cos/#>
```

Chapter 9

AAA - Authentication, Authorisation and Accounting

This chapter describes WeOS AAA support - Authentication, Authorisation and Accounting. The AAA configuration gathers authentication methods and policies in one place and is referenced from other subsystems in WeOS. Four uses of AAA are currently supported:

- *WeOS unit login*: The login password to the unit is part of AAA.
- *Port-based Network Access Control (PNAC)*: WeOS supports port access control with IEEE 802.1X and MAC based authentication. This is configured in two different places, in AAA and as settings related to VLAN. The configuration in AAA specifies RADIUS backends and MAC filtering lists, and the configuration in VLAN which ports are enabled for port access control. See [section 15.2](#) for an introduction and guidance to configure port-based network access control in WeOS.
- *PPP Peer Authentication*: You can create and use local user database lists to authenticate and authorise your PPP peers. This is typically used for PPP connections in dial-in/server mode (see [chapter 35](#)), but you can also use this to authenticate and authorise your peer in other PPP modes.
- *SSL VPN Client Authentication*: When acting as SSL VPN server, a WeOS unit can require clients to provide username and password (in addition to certificates) as part of the authentication step. The username and password credentials are then verified using the WeOS AAA framework. See [chapter 38](#) for more information on SSL VPN security.

9.1 Overview over AAA

Feature	Web	CLI	General Description
AAA methods			Section 9.1.1
Built-in accounts	X	X	Section 9.1.1.1
Local database	X	X	Section 9.1.1.2
Centralised authentication	X	X	Section 9.1.1.3
Authentication chains	X	X	Section 9.1.1.4
Services using AAA			Section 9.1.2
Login	X	X	Section 9.1.2.1
SSL VPN	X	X	Section 9.1.2.2
PPP	X	X	Section 9.1.2.3
IEEE 802.1X	X	X	Section 9.1.2.4
Port-based Network Access Control			Section 15.2
IEEE 802.1X Access	X	X	Section 15.2.1
Control Instances			
MAC authentication lists	X	X	Section 15.2.2

9.1.1 Methods in the AAA framework

9.1.1.1 Built-in interactive user accounts

The table below lists the built-in interactive user accounts in WeOS. These accounts *only apply to the login service*, and some of them are limited to the console port.

Name	Purpose
admin	Administrative account for configuring and management of the device. This is accessible from console, SSH and Web (HTTP/HTTPS) by default. See additional information below and section 9.1.2.1 .
password	Password reset function. Only accessible from console. Can be disabled. See sections 7.1.3.2 and 7.3.11 .
factory	Factory reset function. Only accessible from console. Can be disabled. See sections 7.1.3.2 and 7.3.12 .



Note

Accessing the device using the *admin* account allows full access to the device although the default shell is the WeOS CLI to simplify device management.

The factory default setting for the built-in admin account is as follows:

- Login: **admin**
- Password: **westermo**

The password of the built-in admin user can (and should!!) be changed.



Example

```
example:/#> configure
example:/config/#> aaa
example:/config/aaa/#> username admin YourSecr3t
example:default:/config/aaa/#> username admin YourSecr3t
example:default:/config/aaa/#> show username
admin          $1$ktgeLgQh$SxkJRxF8N01egHXR9WCsK0
example:default:/config/aaa/#> username admin alg sha256 YourSecr3t
example:default:/config/aaa/#> show username
admin          $5$YvUPoBY0IRaudcdL$slKEJG7XMYXrgPe.1eqLkQ1J39PSFDHJLzs4xc6.hz0
example:/config/aaa/#> leave
Configuration activated. Remember "copy run start" to save to flash (NVRAM).
example:/#>
```

Note that the beginning of the password hash shows the type of algorithm on the format \$<ID>\$ where ID is 1 for MD5-crypt, 5 for SHA-256-crypt and 6 for SHA-512-crypt. See Unix crypt¹ for more information about these algorithms.

The admin account password can be at most 64 characters long. Printable ASCII² characters except "space" are allowed in the password, i.e., ASCII 33-126 are allowed.

[Section 7.1.3](#) provides information on how to proceed in case you forget the built-in **admin** account password.

¹Ulrich Drepper's Unix crypt page <https://akkadia.org/drepper/SHA-crypt.txt> (accessed Nov 2021).

²American Standard Code for Information Interchange (ASCII), see e.g. <http://en.wikipedia.org/wiki/ASCII> (accessed May 2009).

9.1.1.2 Local Databases (User Authentication Lists)

Local user databases are useful for storing authentication credentials with no need for any external infrastructure. The lists consist of username and password pairs, which are stored in *plain text*. (Future releases of WeOS may include support for storing *hashed* passwords in the local databases.)

When a local database is created, a numeric ID is associated with it. This ID will be used when mapping this database to, e.g., the login service. Additionally, a description string may be associated with the instance to make it easier to remember its purpose, e.g., "maintainers" for a local database of system maintainers.

Example

```
example:/config/aaa/#> local-db 1
Creating new local db 1
example:/config/aaa/local-db-1/#> description maintainers
example:/config/aaa/local-db-1/#> username alice AliceSecret
example:/config/aaa/local-db-1/#> username bob BobSecret
example:/config/aaa/local-db-1/#> end
example:/config/aaa/#>
```

Usernames can be at most 63 characters long. Alphanumerical characters (a-z, A-Z, and 0-9), underscore (_), dash (-) and period (.) are allowed. A username cannot start with dash (-).

Passwords can be at most 64 characters long. Printable ASCII characters except "space" are allowed in the password, i.e., ASCII 33-126 are allowed.

9.1.1.3 Centralised Authentication Servers

WeOS supports use of centralised authentication via RADIUS and TACACS+. Using a central authentication server simplifies account administration, in particular when you are maintaining a network with many (WeOS) units.

When you define a central authentication server in WeOS, a numeric ID is associated with it. This ID will be used when mapping this server to, e.g., the login service.

Example

```
example:/config/aaa/#> remote-server 1
Creating new remote server 1
example:/config/aaa/remote-server-1/#> password RADIUSecret
```

```
example:/config/aaa/remote-server-1/#> address 192.168.5.1
example:/config/aaa/remote-server-1/#> type radius
example:/config/aaa/remote-server-1/#> auth-port 1812
example:/config/aaa/remote-server-1/#> end
example:/config/aaa/#>
```



Note

A remote server of type TACACS+ will use **chap** as authentication protocol, which is not configurable.

If you are running two (or more) remote-servers for redundancy purposes (both servers have identical user databases and are of the same type) you can add them to a *server group* in WeOS.

- If the WeOS unit gets a response from one server (accept or reject), it will not try the other server(s) in the server group.
- If the request sent to one server times out, it tries to send the request to the next server. This goes on until a response is received or until all servers in the groups have been tried.

When you define a *server group* in WeOS, a numeric ID is associated with it. This ID will be used when mapping the server group to, e.g., the login service.



Example

```
example:/config/aaa/#> remote-server 1
Creating new remote server 1
example:/config/aaa/remote-server-1/#> password TACacSseCret
example:/config/aaa/remote-server-1/#> address 192.168.5.1
example:/config/aaa/remote-server-1/#> type tacacs
example:/config/aaa/remote-server-1/#> auth-port 49
example:/config/aaa/remote-server-1/#> end
example:/config/aaa/#> remote-server 2
example:/config/aaa/remote-server-2/#> password TACacSseCret2
example:/config/aaa/remote-server-2/#> address 10.0.1.3
example:/config/aaa/remote-server-2/#> type tacacs
example:/config/aaa/remote-server-2/#> auth-port 49
example:/config/aaa/remote-server-2/#> end
example:/config/aaa/#> server-group 1
Creating new server group 1
example:/config/aaa/server-group-1/#> server 1,2
example:/config/aaa/server-group-1/#> type tacacs
example:/config/aaa/server-group-1/#> end
```

**Note**

In case the connection between the WeOS unit and the central authentication server traverses an insecure network, the use of VPN services (see [chapter 34](#)) to protect the authentication communication is strongly recommended.

9.1.1.4 Authentication Chains

WeOS supports use of authentication chains. An authentication chain is an *ordered list* of authentication methods, and enables you handle more advanced authentication scenarios. For example, you can create an authentication chain which first contacts a RADIUS server, and then looks in a local database if the RADIUS server does not respond. As of WeOS v4.33.0, use of authentication chains is limited to the *login service*, see also [section 9.1.2](#).

**Example**

```
example:/config/aaa/#> auth-chain 1  
Creating new auth-chain 1  
example:/config/aaa/auth-chain-1/#> method server 1, local-db 1  
example:/config/aaa/auth-chain-1/#> end  
example:/config/aaa/#> login  
example:/config/aaa/login/#> method auth-chain 1  
example:/config/aaa/login/#> end
```

For an authentication chain, you may select up to MAX_AUTH_CHAIN_METHODS (4) methods. You can create up to MAX_AUTH_CHAINS (3) chains.

When using an authentication chain, the methods in that chain will be evaluated in the configured order. The exact behaviour differs when the option "**continue-on-reject**" is enabled or not.

- *Continue-on-reject enabled:* (Default) With continue-on-reject enabled, the chain is evaluated in order and the first method able to verify the user's credentials will result in a valid authentication. If a method returns *reject* (wrong credentials or user not found) or *times out* (no response from a remote server or group of servers), the next method in the chain will be tried. Only when no method in the chain responds "success", the result of the authentication is failure.

Continue-on-reject is enabled by default. This gives a robust behaviour, as it reduces the risk to you lock yourself out by mistake.

- *Continue-on-reject disabled*: With `continue-on-reject` disabled, the chain is evaluated in order, but stops at the first method responding (success or reject). Only if a method is unavailable (no response from a remote server or group of servers), the next method will be tried.

Example

```
example:/config/aaa/#> auth-chain 1  
Creating new auth-chain 1  
example:/config/aaa/auth-chain-1/#> method server 1, local-db 1  
example:/config/aaa/auth-chain-1/#> no continue-on-reject  
example:/config/aaa/auth-chain-1/#> end
```

The main purpose of *disabling continue-on-reject* is when you wish to use a remote server (or server group) as primary authentication method, and *only* fall-back to a local database (or built-in accounts for login service) if the server(s) is unavailable.

Only remote server or server groups can be "unavailable". A lookup in a local user database will always respond "success" or "reject" (the exception is empty local databases, which are ignored and therefore implicitly excluded from the chain). Thus, with `continue-on-reject` disabled it is not meaningful to put a remote server after a local database in a chain, as the authentication procedure will never continue passed the local database.

Warning

Be careful when applying an authentication chain with `continue-on-reject` disabled, as it increases the risk to lock yourself out by mistake.

In particular, the use of a local database in chains with `continue-on-reject` disabled will effectively prohibit fallback to the built-in accounts for the login service.

Hint

To achieve high security for authentication, it is recommended to ensure strong credentials on your accounts (including the built-in "admin" account), rather than disabling "continue-on-reject" in an authentication chain.

There exist dedicated commands to disable the built-in "factory" and "password" accounts, see [section 9.1.1.1](#).

9.1.2 Services utilising the AAA framework

The table below lists the methods available for the different services using the AAA framework. The *built-in account* method is limited to the *login* service on purpose. The *central server*, *local database* and *authentication chain* methods also have limited applicability for different services, but these limitations may be removed in future versions of WeOS.

Service	Central Server	Local DB	Built-in Accounts	Auth-Chains
Login	X	X	X	X
SSL VPN	X	X		
PPP		X		
IEEE 802.1X	X (only RADIUS)			

More information on the services using the AAA framework is given in the sub-sections below.

9.1.2.1 Login Service

The *login* service can utilise all methods in the AAA framework (built-in account³, local database and centralised server) for authenticating the user.

- *Built-in accounts (implicit)*: The use of built-in accounts as login method is implicit. The built-in accounts are tried after any configured login method (local database, centralised server, or authentication chain; special rules apply when "**continue-on-reject**" is disabled, see [section 9.1.1.4](#)).
- *Local database, central server or authentication chain (optional)*: It is possible to configure the use of a local database, central server (single server or server group), or authentication chain as login authentication method. When enabled, the specified method is tried first, typically with fallback to *built-in accounts* if the method fails (timeout or reject).

These optional methods are disabled by default.

Below an example is shown, where a remote-server configured with ID 1 is used to authenticate users logging in to the WeOS unit. If the request sent to the server results in reject or timeout, the WeOS unit falls back to using the *built-in accounts*.

³For the built-in account 'admin', it is also possible to upload an authorised public key for SSH login, see [section 7.3.40](#).

 **Example**

```
example:/config/aaa/#> login
example:/config/aaa/login/#> method server 1
example:/config/aaa/login/#> end
example:/config/aaa/#>
```

A user which has successfully authenticated will be allowed to login to the unit. As of WeOS v4.33.0, any user allowed to login will acquire the highest privilege level⁴. That is, in WeOS v4.33.0 users authenticated via a local database or centralised server will have the same rights as a user logged in using the built-in admin account.

Details regarding reserved usernames for login is given below:

- *Built-in account names*: Use of built-in account names (admin, factory, password) in local databases or central servers is discouraged when using those methods to login to a WeOS unit. In particular, the *factory* and *password* usernames cannot be used to login, but triggers special behaviour when used from the console port.
- *Username "guest"*: As described in the WeOS release notes, support for a guest user (username "guest") is provided as a technology preview. The *guest* can be enabled as additional *built-in* account, and would then get access to a limited set of diagnostic functions in the CLI (no Web). The built-in guest user is disabled by default, but the limitations of the guest user applies to any user logging in with username "guest".

 **Note**

Logging in with username "guest" via local databases or central servers is discouraged in production networks, as it makes use of functionality provided as *technology preview*. See WeOS release notes for further information.

- *Other reserved usernames*: Logging in with other usernames commonly reserved in Unix systems ("root", "nobody", etc.) is prohibited.

To limit login accessibility you can either restrict from where a user can access the CLI or Web, or you can even disable some of the services.

⁴Future versions of WeOS may include support for giving different users different authorisation

- *Disabling access:* It is possible to disable the Web service (HTTP/HTTPS), see [section 8.3.26](#) for details. The CLI can be accessed via console, SSH and Telnet. The CLI cannot be disabled, but it is possible to disable SSH and Telnet (see [section 8.3.33](#) and [8.3.34](#)), thereby limiting CLI access to the console. Telnet is disabled by default.
- *Restricting access:* It is possible to restrict access to Web (HTTP/HTTPS), SSH and Telnet per network interface, using the WeOS management interface feature, see [section 22.2.7](#). For units running WeOS Extended you can configure more fine grain access to these services using the WeOS firewall functionality, see [chapter 33](#).

9.1.2.2 SSL VPN

The WeOS AAA framework can be used to authenticate SSL VPN clients. The SSL VPN client will authenticate itself using a certificate, and *optionally* also via username and password. When using this option, a WeOS unit acting as an SSL VPN Server, can either use a local database or a central server (or server group) to verify the client's username and password.

For more information on SSL VPN in WeOS and the possibility to use username and password for authentication, see [section 38.1.5.1](#).

9.1.2.3 Point-to-Point Protocol (PPP)

The WeOS AAA framework can be for authenticating PPP peers. As of WeOS v4.33.0 only the *local database* method can be used for PPP authentication.

A PPP peer can be a user connecting via an external modem. The most common configuration is to require the peer to authenticate itself when the WeOS device has a server role, but it is also possible to require authentication in a client configuration.

For more information on PPP support in WeOS, see [chapter 35](#).

9.1.2.4 IEEE 802.1X

The WeOS AAA framework can be for authenticating IEEE 802.1X supplicants. As of WeOS v4.33.0 only the *central server* method, of type RADIUS, can be used for 802.1X authentication.

For information on the IEEE 802.1X service in WeOS, see [section 15.2](#).

9.2 Managing AAA via the web interface

9.2.1 Login Account Management via the Web Interface

Menu path: Maintenance ⇒ Password

In this section the password for the built-in account *admin* can be changed.

Change Password

Change password for built-in administrator user account.

The screenshot shows a dialog box with the following elements:

- New Password:** A text input field with a password icon on the right.
- Repeat New Password:** A text input field with a password icon on the right.
- Algorithm:** A dropdown menu currently showing 'MD5-crypt'.
- Buttons:** 'Apply' and 'Cancel' buttons at the bottom.

New Password	Enter the new password for the <i>admin</i> account.
Repeat New Password	To minimise risk of typing error, enter the new password for the <i>admin</i> account once again.
Algorithm	Select password hashing algorithm. The default is to use MD5-crypt.

9.2.2 Select Login Method via the Web Interface

It is possible to add a centralised authentication server/group ([section 9.2.9](#)) or local database ([section 9.2.3](#)) as login method, in addition to the built-in *admin* account.

Menu path: Configuration ⇒ AAA ⇒ Login

Login Management

Method

local-0 (Users) ▼

Apply

Cancel

Method	Select login method from the drop-down box. Only configured local databases and servers/groups, of type RADIUS and TACACS+, will be visible in the box. If <i>Disabled</i> is selected, only the built-in <i>admin</i> account will be enabled.
---------------	---

9.2.3 Local User Databases



Menu path: Configuration ⇒ AAA ⇒ Local User DB

The main page for local user databases shows an overview of created databases.

Local User Databases

ID	Description		
0	Office		
1	Lab		
2	Service		

New

ID	A unique identifier for the local user database.
Description	The users description of this database.
 Edit	Click this icon to edit the user database. See section 9.2.5 for details.
 Delete	Click this icon to remove the user database. You will be asked to acknowledge the removal before it is actually executed.
New	Click this button to add a new user database. See section 9.2.4 for details. You can create at maximum 4 databases.

9.2.4 New Local User Database

Menu path: Configuration ⇒ AAA ⇒ Local Users DB ⇒ **New**

New Local User Database

The screenshot shows a web form titled "New Local User Database". It contains two input fields: "ID" which is pre-filled with the number "3", and "Description" which contains the text "Office". Below these fields are two buttons: "Apply" and "Cancel". At the bottom left of the form area, there is a link labeled "Back to Overview" with a left-pointing arrow.

ID	The local user database identifier. This is generated automatically in the web interface and can not be changed.
Description	Optional. A user defined description for this database that will be visible in listings.

After pressing the **Apply** button, users can be added to the database. See [section 9.2.6](#).

9.2.5 Edit a local user database

Menu path: Configuration ⇒ AAA ⇒ Local Users DB ⇒ 







See [section 9.2.4](#) for descriptions of the fields on this page.

9.2.6 Users

Menu path: Configuration ⇒ AAA ⇒ Local Users DB ⇒ 

The users list is displayed on the edit page for the local user database.

Users

Username		
User1		
User2		
User3		

New User

Username	A username unique in this database.
New User	Press this button to create a new user in this database. See section 9.2.7

9.2.7 New User



Menu path: Configuration ⇒ AAA ⇒ Local Users DB ⇒  ⇒ **New User**

New User

Username	<input type="text"/>
Password	<input type="password"/>

Username	A username unique in this database.
Password	The password for this user.

9.2.8 Edit User

Menu path: Configuration ⇒ AAA ⇒ Local Users DB ⇒  ⇒  (Users table)

See [section 9.2.7](#) for descriptions of the fields on this page.





9.2.9 Remote Server overview

Menu path: Configuration ⇒ AAA ⇒ Remote Server

The main page for Remote Server shows an overview of configured server groups and the remote server configurations.











Remote Server

Server Groups

ID	Description	Type	Servers		
0	TACACS group	TACACS+	Primary (3), Secondary (0), backup (1)		
1		RADIUS	Test server (2), (4)		



[New Group](#)

Remote Servers



ID	Description	Type	Address	Auth Port		
0	Secondary	TACACS+	198.18.1.99	42		
1	backup	TACACS+	s1.bob.gov	Auto (49)		
2	Test server	RADIUS	10.1.1.1	Auto (1812)		
3	Primary	TACACS+	main.bob.gov	Auto (49)		
4		RADIUS	alice.net	1813		

[New Server](#)

9.2.9.1 Server Groups in the overview

ID	The group identifier
Description	The user defined name of this group
Type	The type of remote servers in the group (RADIUS or TACACS+), which can not be mixed.
Servers	List of servers included in this group. Each server is presented by its description name and the server identifier inside parentheses
 Edit	Click this icon to edit the RADIUS group. See section 9.2.10 for details.
 Delete	Click this icon to remove the group. You will be asked to acknowledge the removal before it is actually executed. Removing a group will not remove the config of the included servers.
New Group	Click this button to add a new group. See section 9.2.11 for details. You can create at maximum 2 groups.

9.2.9.2 Remote servers in the overview

ID	The remote server identifier
Description	The user defined name on this server
Type	The type of remote servers (RADIUS or TACACS+).
Address	IP or FQDN of the server
Auth Port	The port used for authentication
 Edit	Click this icon to edit the remote server setting. See section 9.2.12 for details.
 Delete	Click this icon to remove the remote server setting. You will be asked to acknowledge the removal before it is actually executed.
New Server	Click this button to add a new remote server configuration. See section 9.2.13 for details. You can define at maximum 6 remote server configurations.

9.2.10 Edit a server group

Menu path: Configuration ⇒ AAA ⇒ Remote Server ⇒  (Server Groups)

Edit Server Group

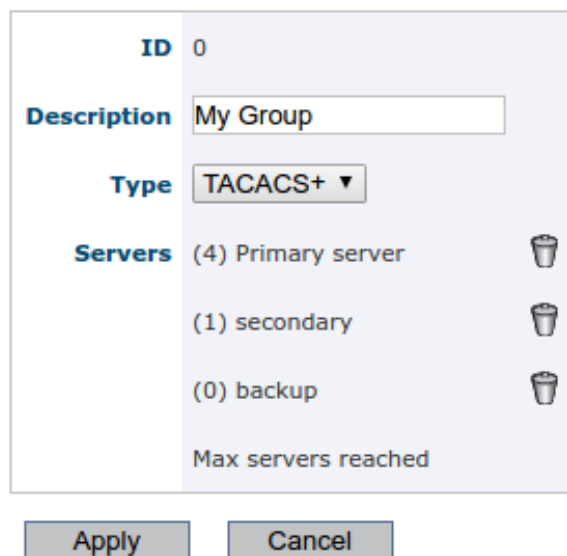

ID	The group identifier. This is generated automatically in the web interface and can not be changed.
Description	Optional. A user defined name for this group that will be visible in listings.
Type	The group type (RADIUS or TACACS+).
Servers	Remote servers that are included in this group. The order of this list is important as it defines the order that servers are queried. Select a server in the drop-down list and add it by clicking the plus icon. Only remote servers of the same type as the group will be added. Use the  icon to remove a server from the group. You are limited to max 3 servers per group.

9.2.11 Add a server group

Menu path: Configuration ⇒ AAA ⇒ Remote Server ⇒ New Group

New Server Group

The screenshot shows a configuration dialog box titled "New Server Group". It contains the following fields and controls:

- ID**: 1
- Description**: An empty text input field.
- Type**: A dropdown menu with "RADIUS" selected.
- Servers**: A dropdown menu with a plus sign icon to its right, indicating a list of servers.
- Buttons**: "Apply" and "Cancel" buttons at the bottom.

See [section 9.2.10](#) for descriptions of the fields on this page. You can have at maximum 2 server groups.

9.2.12 Edit a remote server

Menu path: Configuration ⇒ AAA ⇒ Remote Server ⇒  (Remote Servers)

Edit Remote Server

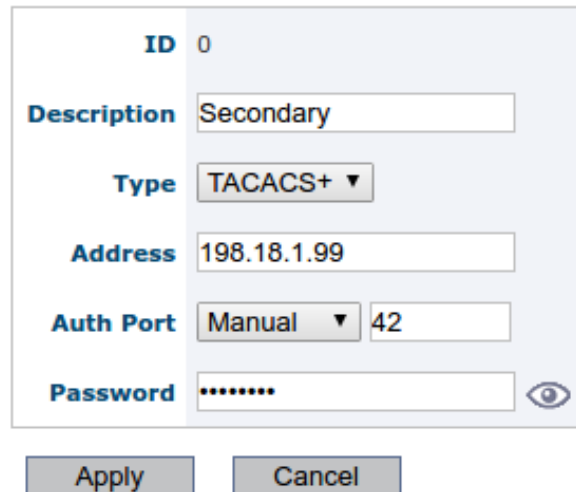

The screenshot shows a configuration form for a remote server. The fields are as follows:

- ID:** 0
- Description:** Secondary
- Type:** TACACS+ (dropdown menu)
- Address:** 198.18.1.99
- Auth Port:** Manual (dropdown menu) and 42 (input field)
- Password:** Masked with dots, with a toggle icon to show/hide.

Buttons: Apply, Cancel

ID	The remote server identifier. This is generated automatically in the web interface and can not be changed.
Description	Optional. A user defined name for this server configuration that will be visible in listings.
Type	The type of remote-servers (RADIUS or TACACS+).
Address	Mandatory. The IP number or Fully Qualified Domain Name (FQDN) to the remote server
Auth Port	Mandatory. The port number for server authentication requests. The default and standardised port number for this is 1812 for RADIUS and 49 for TACACS+ but can be changed here if needed. If port number 0 is entered, the standardised port number will be configured.
Secret	A shared secret (password) that should be used to encrypt the communication with this server.

9.2.13 Add a remote server

Menu path: Configuration ⇒ AAA ⇒ Remote Server ⇒ New Server

New Remote Server

ID	5
Description	<input type="text"/>
Type	RADIUS ▼
Address	<input type="text"/>
Auth Port	Auto ▼ 1812
Password	<input type="password"/> 

See [section 9.2.12](#) for descriptions of the fields on this page. You can have at maximum 6 remote server configurations.

9.2.14 Authentication Chains Overview



Menu path: Configuration ⇒ AAA ⇒ Auth Chain

The main page for authentication chains shows an overview of created chains.

Authentication Chain

ID	Description	Methods	
0	Chain 0	server 2, server 3	 
1	Chain 1	local-db 1, server 2	 

[New](#)

ID	A unique identifier for the authentication chain.
Description	The users description of the authentication chain.
Methods	An ordered list of the methods in the authentication chain.
 Edit	Click this icon to edit the authentication chain. See section 9.2.16 for details.
 Delete	Click this icon to remove the authentication chain. You will be asked to acknowledge the removal before it is actually executed.
New	Click this button to add a new authentication chain. See section 9.2.15 for details. You can create at maximum 4 authentication chains.

9.2.15 New Authentication Chain

Menu path: Configuration ⇒ AAA ⇒ Auth Chain ⇒ **New**

Authentication Chain

ID 2

Description

Continue on Reject

Methods

Method	
local-db-1 ()	
server-2 ()	

local-db-1 ()

ID	The authentication chain identifier. This is generated automatically in the web interface and can not be changed.
Description	Optional. A user defined description for this authentication chain that will be visible in listings.
Continue on Reject	Default Enabled. If enabled continue to next method if rejected, if disabled stop on reject, only continue if method unavailable. See section 9.1.1.4 for more information.
Methods	The list of methods. Select method and click the Add to add the method to the list.

Press the **Apply** button to store changes.

9.2.16 Edit an authentication chain

Menu path: Configuration ⇒ AAA ⇒ Auth Chain ⇒

Click the pen icon in the overview page to edit a specific chain. See [section 9.2.15](#) for descriptions of the fields on this page.

9.2.17 IEEE 802.1X authentication

Menu path: Configuration ⇒ AAA ⇒ 802.1X

Here you see a listing of currently configured 802.1X instances.

802.1X Authentication

ID	Enabled	Description	Method		
0		1Xauth	(group-0) AuthGroup		

[New](#)

ID	The IEEE 802.1X instance identifier
Enabled	If this instance is active, A green check-mark means yes and a dash means no
Description	The user defined name on this IEEE 802.1X instance
Method	The server or group used for authentication, which needs to be of type RADIUS.
Edit	Click this icon to edit the instance See section 9.2.18 for details.
Delete	Click this icon to remove the instance. You will be asked to acknowledge the removal before it is actually executed. Removing an IEEE 802.1X instance will not remove the referenced RADIUS group or server.
New	Click this button to add a new IEEE 802.1X instance. See section 9.2.19 for details. <i>You can currently only create one instance.</i>

9.2.18 Edit an IEEE 802.1X instance

Menu path: Configuration ⇒ AAA ⇒ 802.1X ⇒ 

Edit 802.1X Authentication

ID 1

Enabled

Description

Method (group-0) AuthGroup ▾

Active Authentication Disabled ▾

Re-Authenticate Disabled ▾

ID	The IEEE 802.1X instance identifier. This is generated automatically in the web interface and can not be changed.
Enabled	Check to enable this instance.
Description	Optional. A user defined name for this instance.
Method	Mandatory. Use this drop-down menu to select a RADIUS group or a remote RADIUS server. Remote servers and groups, of type RADIUS, are created separately. See section 9.2.11 and section 9.2.13 .
Active Authentication	Enable/disable Authentication initiation
Re-Authenticate	Enable/disable periodic reauthentication

IMPORTANT: Creating an IEEE 802.1X instance does *not* in itself activate authentication. Port access is managed in the VLAN configuration. See [sections 15.2](#) and [15.3.4](#). The instance here must be referenced from the port access configuration for it to be used!

9.2.19 Add an IEEE 802.1X instance

Menu path: Configuration ⇒ AAA ⇒ 802.1X ⇒ New

New 802.1x Authentication

ID	0
Enabled	<input checked="" type="checkbox"/>
Description	<input type="text"/>
Method	None

See [section 9.2.18](#) for descriptions of the fields on this page. *You can currently only configure one IEEE 802.1X instance.*

9.2.20 MAC based authentication

Menu path: Configuration ⇒ AAA ⇒ MAC Auth

Here you see a listing of currently configured MAC authentication lists.

MAC Authentication Lists

ID	Enabled	Description		
1		MAC list 1		

[New List](#)

ID	The MAC authentication list identifier
Enabled	If this list is active, A green check-mark means yes and a dash means no
Description	The user defined name on this MAC authentication list
Edit	Click this icon to edit the list See section 9.2.21 for details.
Delete	Click this icon to remove the list. You will be asked to acknowledge the removal before it is actually executed.
New List	Click this button to add a new MAC authentication list. See section 9.2.22 for details. You can create up to 8 MAC authentication lists.

9.2.21 Edit a MAC authentication list

Menu path: Configuration ⇒ AAA ⇒ MAC Auth ⇒ 

Edit MAC Authentication List

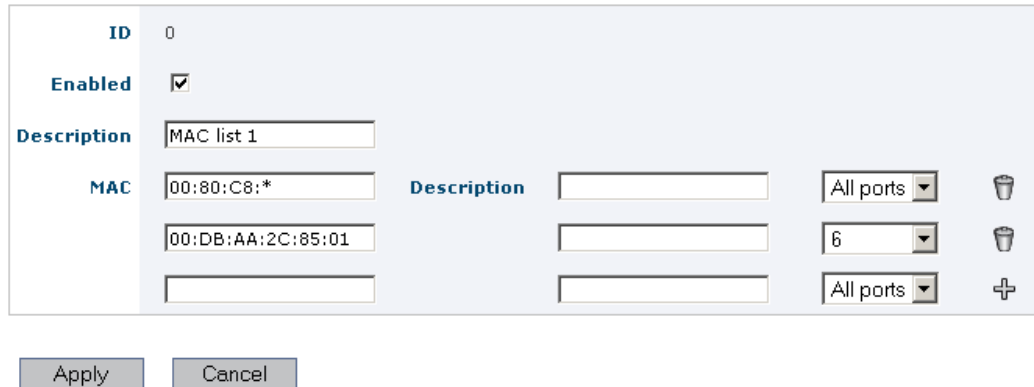

ID	The MAC authentication list identifier. This is generated automatically in the web interface and can not be changed.
Enabled	Check to enable this list.
Description	Optional. A user defined name for this list.
MAC	Optional. A list of MAC addresses and MAC address patterns. Single MAC addresses are specified in the format: <i>HH:HH:HH:HH:HH:HH</i> . A wildcard * can be used at the end of the pattern to match a block of addresses. Examples: <i>00:80:C8:*</i> , <i>00:D8:AA:2C:85:01</i> . Use the drop-down list to select a port if you want the pattern to only be valid for requests coming in through a specific port. The description field is optional. Add a pattern by clicking on the plus icon. Use the  icon to remove a pattern. A list is limited to max 44 addresses/patterns.

IMPORTANT: Creating a MAC authentication list does *not* in itself activate filtering of addresses. Port access is managed in the VLAN configuration. See [sections 15.2](#) and [15.3.4](#). The created MAC authentication list must be referenced from the port access configuration for it to be used!

9.2.22 Add a new MAC authentication list

Menu path: Configuration ⇒ AAA ⇒ MAC Auth ⇒ New List

New MAC Authentication List

ID	0
Enabled	<input checked="" type="checkbox"/>
Description	<input type="text"/>
MAC	<input type="text"/> All ports <input type="button" value="⊕"/>

See [section 9.2.21](#) for descriptions of the fields on this page.

9.3 Managing AAA via the CLI

The table below shows AAA management features available via the CLI.

Command	Default	Section
<u>Account management (Login)</u>		
aaa		Section 9.3.1
username <USERNAME>		Section 9.3.2
[alg <md5 sha256 sha512>]		
[hash] <PASSWORD>		
login		Section 9.3.3
[no] method <local-db <ID> server <ID>		Section 9.3.4
server-group <ID> auth-chain <ID> >		
<u>Local User Database Lists (PPP, ...)</u>		
aaa		
local-db <ID> [plain]		Section 9.3.5
[no] username <USERNAME><PASSWORD>		Section 9.3.6
[No] description <STRING>		Section 9.3.7
<u>Configure Remote Server Connectors</u>		
aaa		
[no] remote-server <ID> [type <TYPE>]		Section 9.3.8
type <radius tacacs>	radius	Section 9.3.9
[no] description <STRING>		Section 9.3.10
[no] address <IP FQDN>		Section 9.3.11
[no] password <PASSWORD>		Section 9.3.12
[no] auth-port <PORT>	1812 49	Section 9.3.13
<u>Configure Server Groups</u>		
aaa		
[no] server-group <GID> [type <TYPE>]		Section 9.3.14
type <radius tacacs>	radius	Section 9.3.15
[no] description <STRING>		Section 9.3.16
[no] server <ID ID,ID ID,ID,ID>		Section 9.3.17
		Continued on next page

Continued from previous page		
Command	Default	Section
<u>Configure Authentication Chains</u>		
aaa		
[no] auth-chain <ID>		Section 9.3.18
[no] method <group <GID> server <ID> local-db <ID>, ... >		Section 9.3.19
[no] description <STRING>		Section 9.3.20
[no] continue-on-reject	Enabled	Section 9.3.21
<u>Configure IEEE 802.1X Authentication</u>		
aaa		
[no] dot1x-auth <ID>		Section 9.3.22
[no] enable	Enabled	Section 9.3.23
[no] description <STRING>		Section 9.3.24
[no] method <group <GID> server <ID>>		Section 9.3.25
[no] active-authentication [INTERVAL]	Enabled	Section 9.3.26
[no] re-authenticate [INTERVAL]	Disabled	Section 9.3.27
<u>Configure MAC Authentication Lists</u>		
aaa		
[no] mac-auth <ID>		Section 9.3.28
[no] enable	Enabled	Section 9.3.29
[no] description <STRING>		Section 9.3.30
[no] mac match <MAC-PATTERN> [limit <PORT>] [description <STRING>]		Section 9.3.31

9.3.1 Manage AAA Settings

Syntax aaa

Context [Global Configuration](#) context

Usage Enter AAA Configuration context (Authentication, Authorisation and Accounting). The AAA context is used for managing user account settings, etc.

Use **"show aaa"** to show all configured AAA settings: list the local users and any configured remote servers, server groups, IEEE 802.1X authentications and MAC authentications.

Default values Not applicable.

9.3.2 Changing Built-in Account Password

Syntax `username <USERNAME> [alg <md5|sha256|sha512>]
[hash] <PASSWORD>`

Context AAA Configuration context

Usage Change password of a certain user account, e.g., the **"admin"** account. By default, the password is entered as clear-text, and saved as a hash.

By default the hashing algorithm is MD5-crypt. The optional keyword **"alg"** can be used to change the algorithm to SHA256-crypt or SHA512-crypt. Note that the **"alg"** keyword can not be used at the same time as the **"hash"** keyword (described below) is used.

The **"hash"** keyword is not intended to be used by regular users - instead it is used by the switch itself when reading a configuration file including a hashed password. By adding the **"hash"** keyword, the system expects that a hashed password is entered (as opposed to a clear-text password).

Use **"show username <USERNAME>"** to show the hashed password for the specified user.

Default values Password is entered in clear-text.

Example Setting the **"admin"** password to **"foobar"**.

Example

```
example:/config/aaa/#> username admin foobar  
example:/config/aaa/#>
```

9.3.3 Manage AAA Login Settings

Syntax `login`

Context AAA Configuration

Usage Enter AAA Login Configuration context. The AAA Login Configuration context is currently only used for managing the login *method*, see [section 9.3.4](#).

9.3.4 Manage AAA Login Method

Syntax [no] method <local-db <ID> | server <ID> | server-group <ID>
|
auth-chain <ID> >

Context [AAA Login Configuration](#)

Usage Select login *method*. If the method is disabled, only the built-in **admin** account ([section 9.3.2](#)) can be used to login to the Web/CLI.

- *local-db*: If a *local-db* ([section 9.3.5](#)) is selected, then all configured users in that database will be able to log in and get the same privileges as the built-in admin account.
- *Server or Server Group*: Select *server* ([section 9.3.8](#)) to use one remote server as authentication backend and select *server-group* ([section 9.3.14](#)) to use a group of remote servers as authentication backend.

Server users will also have the same privileges as the built-in admin account. Server-group is used for redundancy. All servers inside one group is supposed to have the same set of user accounts and must be of the same type. Having different sets of accounts for servers inside the same server-group is not supported.

- *Authentication Chain*: Select *auth-chain* ([section 9.1.1.4](#)) to use a chain of authentication methods, tried in order.

Use **"no method"** to disable any configured login method.

Use **"show method"** to show the configured login method.

Note

As of WeOS v4.33.0 it is only possible to select one login method, and it is not possible to disable the built-in admin account. When a login method is chosen the built-in admin account will still be there, last in the authentication chain.

Default values Disabled

Examples

- Using a remote server for login authentication:

 **Example**

```
example:/config/aaa/#> remote-server 1
Creating new remote server 1
Error: Missing remote server password.

example:/config/aaa/remote-server-1/#> password RADiuSseCret
Error: Missing remote server address.

example:/config/aaa/remote-server-1/#> address 192.168.5.1
example:/config/aaa/remote-server-1/#> type radius
example:/config/aaa/remote-server-1/#> end
example:/config/aaa/#> login
example:/config/aaa/login/#> method server 1
example:/config/aaa/login/#> end
example:/config/aaa/#>
```

- Using a server group, of type TACACS+, for login authentication:

 **Example**

```
example:/config/aaa/#> remote-server 1
Creating new remote server 1
Error: Missing remote server password.

example:/config/aaa/remote-server-1/#> password TACacSseCret
Error: Missing remote server address.

example:/config/aaa/remote-server-1/#> address 192.168.5.1
example:/config/aaa/remote-server-1/#> type tacacs
example:/config/aaa/remote-server-1/#> end
example:/config/aaa/#> remote-server 2
Creating new remote server 2
Error: Missing remote server password.

example:/config/aaa/remote-server-2/#> password TACacSseCret2
Error: Missing remote server address.

example:/config/aaa/remote-server-2/#> address 10.0.1.3
example:/config/aaa/remote-server-2/#> type tacacs
example:/config/aaa/remote-server-2/#> end
example:/config/aaa/#> server-group 1
Creating new server group 1
example:/config/aaa/server-group-1/#> server 1,2
example:/config/aaa/server-group-1/#> type tacacs
example:/config/aaa/server-group-1/#> end
```

```
example:/config/aaa/#> login
example:/config/aaa/login/#> method group 1
example:/config/aaa/login/#> end
example:/config/aaa/#>
```

- Using a local user database for login:

Example

```
example:/config/aaa/#> local-db 1
Creating new local db 1
example:/config/aaa/local-db-1/#> username alice AliceSecret
example:/config/aaa/local-db-1/#> username bob BobSecret
example:/config/aaa/local-db-1/#> end
example:/config/aaa/#> login
example:/config/aaa/login/#> method local-db 1
example:/config/aaa/login/#> end
example:/config/aaa/#>
```

9.3.5 Manage Local User Database Lists

Syntax [no] local-db <ID> [<TYPE>]

Context AAA Configuration context

Usage Enter Local User Database Configuration context to create, modify or remove a local user database.

Use "**local-db <ID>**" to create a local database, or to enter the configuration context of an existing database. "**ID**" must be a number greater or equal to 0 and is referenced from other commands. As of WeOS v4.33.0, you can specify up to 4 local databases.

An optional "**TYPE**" parameter is used to specify how passwords within the database are stored. The only supported type in the current version of WeOS is "**plain**", which means that all passwords are stored as plain text.

Use "**no local-db <ID>**" to remove a specific database, or "**no local-db**" to remove all configured databases.

To list all configured databases, use "**show local-db**".

Default values The "**TYPE**" parameter is "**plain**" by default.

9.3.6 Add/Delete User in Local Database List

Syntax [no] username <USERNAME> <SECRET>

Context [Local User Database Configuration](#) context

Usage Add or remove users to or from the database.

Use **"username <USERNAME> <SECRET>"** to add a new user called **"USERNAME"**, whose password is **"SECRET"**.

Use **"no username <USERNAME>"** to remove a specific user from the database.

To list all the users in the database, use **"show username"**. To show the credentials of a particular user, use **"show username <USERNAME>"**.

Default values Not Applicable.

Examples



Example

```
example:/config/aaa/local-db-0/#> username alpha foobar  
example:/config/aaa/local-db-0/#>
```

9.3.7 Local Database List Description Setting

Syntax [no] description <STRING>

Context [Local User Database Configuration](#) context

Usage Set or remove the local user database description string.

Use **"description <STRING>"** to set a description for this database.

Use **"no description"** to remove the current description.

Use citation marks around the string if you want to have a description containing space characters.

To view the current description, use **"show description"**.

Default values Empty.

Examples

 **Example**

```
example:/config/aaa/local-db-0/#> description PPPUsers  
or ...  
example:/config/aaa/local-db-0/#> description "PPP Users"
```

9.3.8 Manage Remote Server Connectors

Syntax [no] remote-server <ID> [type <TYPE>]

Context [AAA Configuration](#) context

Usage Enter Remote Server Configuration context to create, modify or remove a server connector.

Use **"remote-server <ID>"** to create a new connector, or to enter the configuration context of an existing connector. **"ID"** must be a number greater or equal to 0 and is referenced from other commands. As of WeOS v4.33.0, you can specify up to 6 server connectors.

An optional **"type"** parameter is used to specify the type of server. The supported types are **"radius"** and **"tacacs"**.

Use **"no remote-server <ID>"** to remove a specific server, or **"no remote-server"** to remove all configured servers.

Use **"show remote-server"** to list all configured connectors, or **"show remote-server <ID>"** to show information on a specific connector.

Default values The **"type"** parameter is **"radius"** by default.

9.3.9 Set Remote Server Type

Syntax type <TYPE>

Context [Remote Server Configuration](#) context

Usage Set the remote server type.

Use this command to specify the type of a remote server connector. The supported types are **"radius"** and **"tacacs"**

Use **"show type"** to show the configured remote server type.

Default values **"radius"**

9.3.10 Configure Remote Server Description

Syntax [no] description <STRING>

Context Remote Server Configuration context

Usage Set or remove the remote server description string.

Use **"description <STRING>"** to set a description for this server or

"no description" to remove the current description.

Use citation marks around the string if you want to have a description containing space characters.

Use **"show description"** to show the configured remote server description.

Default values Empty.

Examples



Example

```
example:/config/aaa/remote-server-0/#> description MyRadius  
or ...  
example:/config/aaa/remote-server-0/#> description "Backup server"
```

9.3.11 Configure Remote Server Address

Syntax [no] address <IP | FQDN>

Context Remote Server Configuration context

Usage Set or remove the remote server address.

Use this command to point out the remote server address. You can use an IP address or a name. Names will be looked up via DNS.

Use **"show address"** to show the configured remote server address.

Default values Empty. This will reject authentication for the services using this server.

Examples

 **Example**

```
example:/config/aaa/remote-server-0/#> address 1.2.3.4  
or ...  
example:/config/aaa/remote-server-0/#> address myserver.mydomain.se
```

9.3.12 Configure Remote Server Password

Syntax [no] password <PASSWORD>

Context [Remote Server Configuration](#) context

Usage Set or remove the remote server password.

Use this command to set the shared secret password to use with this server.

Use **"show password"** to show the configured remote server password setting.

Default values Empty. Mandatory to configure.

9.3.13 Configure Remote Server Authentication Port

Syntax [no] auth-port <PORT>

Context [Remote Server Configuration](#) context

Usage Set the port number used when communicating with the remote server.

The default port value for authentication requests using RADIUS is 1812 and 49 for TACACS+. **"no auth-port"** will reset the value to the standard port number for the specific server type.

Use **"show auth-port"** to show the configured port used for authentication requests to the server.

Default values 0, automatically changed to the standard port number for the chosen server type.

9.3.14 Manage Server Groups

Syntax [no] server-group <GID> [type <TYPE>]

Context [AAA Configuration](#) context

Usage Enter Server Group Configuration context to create, modify or remove a server group.

Use **"server-group <GID>"** to create a new group, or to enter the configuration context of an existing group. **"GID"** must be a number greater or equal to 0 and is referenced from other commands.

An optional **"type"** parameter is used to specify the type of server. The supported types in the current version of WeOS are **"radius"** and **"tacacs"**. You can specify up to 2 server groups in this version of WeOS.

Use **"no server-group <GID>"** to remove a specific group, or **"no server-group"** to remove all configured groups.

Use **"show server-group"** to list all configured server groups, or **"show server-group <GID>"** to show information on a specific server group (also available as **"show"** command within the Server Group Configuration context).

Default values The **"type"** parameter is **"radius"** by default.

9.3.15 Set Server Group Type

Syntax type <TYPE>

Context [Server Group Configuration](#) context

Usage Set the server group type.

Use this command to specify the type of the servers included in the group. The supported types in the current version of WeOS are **"radius"** and **"tacacs"**.

Use **"show type"** to show the configured server group type.

Default values **"radius"**

9.3.16 Configure Server Group Description

Syntax [no] description <STRING>

Context [Server Group Configuration](#) context

Usage Set or remove the server group description string.

Use **"description <STRING>"** to set a description for this group or **"no description"** to remove the current description. Use citation marks

around the string if you want to have a description containing space characters.

Use **"show description"** to show the configured server group description.

Default values Empty.

Examples

Example

```
example:/config/aaa/server-group-0/#> description MyGroup  
or ...  
example:/config/aaa/server-group-0/#> description "Backup servers"
```

9.3.17 Configure Server Group Members

Syntax [no] server <ID|ID,ID|ID,ID,ID>

Context [Server Group Configuration](#) context

Usage Set the server(s) that are included in the server group.

Use this command to specify which servers belong to this server group. You can specify up to three servers comma separated by their remote server ID. Each server must be configured separately before the group is set up and need to be of the same type as the group. Mixing types is not allowed. See [section 9.3.8](#).

Note

The order of the servers IS important and is used as fall-back order. The first (leftmost) defined server in the group is queried first. If the first server returns an error or does not reply the second is queried and so on.

Use **"show server"** to show the configured members of the server group (listed order is fall-back order).

Default values Empty. This will reject authentication for the services using this group.

9.3.18 Manage Authentication Chains

Syntax [no] auth-chain <ID>

Context [AAA Configuration](#) context

Usage Enter Authentication Chain Configuration context to create or modify an authentication chain.

Use **"auth-chain <ID>"** to create a new chain, or to enter the configuration context of an existing chain. **"ID"** must be a number greater or equal to 0 and is referenced from other commands.

Use **"no auth-chain <ID>"** to remove a specific chain, or **"no auth-chain"** to remove all configured chains.

Use **"show auth-chain"** to list all configured chains, or **"show auth-chain <ID>"** to show information on a specific chain (also available as **"show"** command within the Authentication Chain Configuration context).

Default values Not applicable

9.3.19 Set Authentication Chain Methods

Syntax [no] method <group <GID> | server <ID> | local-db <ID>, ...>

Context [Authentication Chain Configuration](#) context

Usage Set the ordered list of authentication methods.

Use this command to specify which methods belong to this chain. The supported types in the current version of WeOS are **"server"**, **"group"** and **"local-db"**. You can specify up to 4 comma-separated methods. Each method must be configured separately before the chain is set up.

 **Note**

The order of the methods is important, since the methods are queried in the order defined. The first (leftmost) method in the chain is queried first. See [section 9.1.1.4](#) for more information on how the methods are queried.

Use **"show method"** to show the configured methods of the authentication chain.

Use **"no method"** to remove configured methods from this chain.

Default values Not applicable

Examples



Example

```
example:/config/aaa/auth-chain-0/#> method server 1, local-db 1
```

9.3.20 Configure Authentication Chain Description

Syntax [no] description <STRING>

Context [Authentication Chain Configuration](#) context

Usage Set or remove the authentication chain description string.

Use **"description <STRING>"** to set a description for this chain or **"no description"** to remove the current description. Use quotation marks around the string if you wish to have a description containing space characters.

Use **"show description"** to show the configured authentication chain description.

Default values Empty.

Examples



Example

```
example:/config/aaa/auth-chain-0/#> description MyChain  
or ...  
example:/config/aaa/auth-chain-0/#> description "The Chain"
```

9.3.21 Authentication Chain Continue on Reject

Syntax [no] continue-on-reject

Context [Authentication Chain Configuration](#) context

Usage Enable/disable the continue-on-reject functionality. If enabled continue to next method if rejected. If disabled stop on reject, only continue if a method is unavailable. See [section 9.1.1.4](#) for more information.

Default values Disabled

9.3.22 Manage IEEE 802.1X authentication instances

Syntax [no] dot1x-auth <ID>

Context [AAA Configuration](#) context

Usage Enter 802.1X Configuration context to create, modify or remove an IEEE 802.1X authentication instance.

Use **"dot1x-auth <ID>"** to create a new 802.1X authentication instance, or to enter the configuration context of an existing instance. (As of WeOS v4.33.0 you can only create one 802.1X authentication instance.) **"ID"** must be a number greater or equal to 0 and is referenced from other commands.



Important

Creating an IEEE 802.1X authentication instance does *not* in itself activate authentication. Port access is managed in the VLAN configuration. See [section 15.2](#). The created 802.1X instance must be referenced from the port access configuration for it to be used!

Use **"no dot1x-auth <ID>"** to remove a specific instance, or **"no dot1x-auth"** to remove all 802.1X instances.

Use **"show dot1x-auth"** to list all 802.1X authentication instances, or **"show dot1x-auth <ID>"** to show information on a specific instance (also available as **"show"** command within the 802.1X Configuration context).

Default values Not applicable.

9.3.23 Enable/Disable an IEEE 802.1X authentication instance

Syntax [no] enable

Context [802.1X Configuration](#) context

Usage Enable or disable an 802.1X authentication instance.

Use **"no enable"** to disable.

Use **"show enable"** to show whether this instance is enabled or disabled.

Default values Enabled.

9.3.24 Set IEEE 802.1X authentication instance description

Syntax [no] description <STRING>

Context [802.1X Configuration](#) context

Usage Set or remove the description string for this 802.1X authentication instance.

Use **"description <STRING>"** to set a description or **"no description"** to remove the current description. Use citation marks around the string if you want to have a description containing space characters.

Use **"show description"** to show the configured instance description setting.

Default values Empty.

Examples

Example

```
example:/config/aaa/dot1x-auth-0/#> description My_1X_net  
or ...  
example:/config/aaa/dot1x-auth-0/#> description "Employees only"
```

9.3.25 Configure IEEE 802.1X authentication back-end servers

Syntax [no] method <group <GID>|server <ID>>

Context [802.1X Configuration](#) context

Usage Set or remove the back-end method for the 802.1X authentication instance.

IEEE 802.1X commonly use the RADIUS protocol as back-end. A RADIUS server connection or a server group must be configured separately before you can use the method command. See sections [9.3.8](#) and [9.3.14](#).

Use the syntax **"method group <GID>"** to select a specific RADIUS server group as back-end.

Use the syntax **"method server <ID>"** to select a specific RADIUS server as back-end.

Use **"no method"** to remove the back-end selection setting.

Use **"show method"** to show the ID/GID of the configured back-end server or back-end server group.

Default values No backend. 802.1X authentication attempts will fail.

9.3.26 Configure IEEE 802.1X active authentication

Syntax [no] active-authentication [INTERVAL]

Context [802.1X Configuration](#) context

Usage Enable/Disable authenticator initiated authentication. When enabled, authenticator actively sends EAP-Requests every INTERVAL seconds (default 30) until a supplicant successfully authenticates.

For example, **"active-authentication 60"** enables authenticator initiated authentication with interval 60 seconds.

Use **"no active-authentication"** to disable authenticator initiated authentication.

Use **"show active-authentication"** to show the current setting.

Default values Enabled (interval 30 seconds)

9.3.27 Configure IEEE 802.1X reauthenticate

Syntax [no] re-authenticate [INTERVAL]

Context [802.1X Configuration](#) context

Usage Enable/disable periodic reauthentication. When enabled, authenticator requires the supplicant to reauthenticate itself every INTERVAL seconds (default 3600).

Use **"re-authenticate"** to enable periodic reauthentication with the default interval (3600 seconds), or for example **"re-authenticate 600"** to enable reauthentication every 600 seconds.

Use **"no re-authenticate"** to disable periodic reauthentication.

Use **"show re-authenticate"** to show the current setting.

Default values Disabled (when enabled, default interval is 3600 seconds)

9.3.28 Manage MAC authentication lists

Syntax [no] mac-auth <ID>

Context [AAA Configuration](#) context

Usage Create, modify or remove a MAC authentication list.

Use **"mac-auth <ID>"** to create a new list, or to enter the configuration context of an existing list. **"ID"** must be a number greater or equal to 0 and is referenced from other commands. As of WeOS v4.33.0, you can create up to 8 MAC authentication lists.



Important

Creating a MAC authentication list does *not* in itself activate filtering of addresses. Port access is managed in the VLAN configuration. See [section 15.2](#). The created MAC authentication list must be referenced from the port access configuration for it to be used!

Use **"no mac-auth <ID>"** to remove a specific list, or **"no mac-auth"** to remove all configured MAC authentication lists.

Use **"show mac-auth"** to list all MAC authentication lists, or **"show mac-auth <ID>"** to show information on a specific instance (also available as **"show"** command within the MAC Authentication List Configuration context).

Default values Not applicable.

9.3.29 Enable/Disable a MAC authentication list

Syntax [no] enable

Context [MAC Authentication List Configuration](#) context

Usage Enable or disable a MAC authentication list.

Use **"no enable"** to disable.

Use **"show enable"** to show whether this list is enabled or disabled.

Default values Enabled.

9.3.30 Set MAC authentication list description

Syntax [no] description <STRING>

Context [MAC Authentication List Configuration](#) context

Usage Set or remove the description string for this list.

Use **"description <STRING>"** to set a description or **"no description"** to remove the current description. Use citation marks around the string if you want to have a description containing space characters.

Use **"show description"** to show the configured list description setting.

Default values Empty.

Examples



Example

```
example:/config/aaa/mac-auth-0/#> description MyMACList
or ...
example:/config/aaa/mac-auth-0/#> description "Trusted MAC addresses"
```

9.3.31 Configure MAC authentication list filters

Syntax [no] mac match <MAC-PATTERN> [limit <PORT>]
[description <STRING>]

Context [MAC Authentication List Configuration](#) context

Usage Add or remove MAC filter patterns.

A MAC Authentication List is built up by MAC filter patterns. Use the syntax **"mac match <MAC-PATTERN>"** to create a new filter pattern. To match a single MAC address specify the hardware Ethernet MAC in the format *HH:HH:HH:HH:HH:HH* as <MAC-PATTERN>. You can also specify whole blocks of addresses by using a wild-card * at the end of the pattern. You can also optionally filter on the port by using the **"limit"** argument to this command. A comment may also be added with the optional **"description"** argument.

Use **"no mac match <MAC-PATTERN>"** to remove a specific filter, or **"no mac"** to remove all filters in this list.

As of WeOS v4.33.0, you can create up to 44 MAC filter patterns per MAC authentication list.

Use "**show mac**" to show the defined MAC filter rules for this authentication list.

Default values Empty, no filters.

Examples

 **Example**

```
mac-auth-0/#> mac match 00:D8:AA:2C:85:01  
or with wildcard...  
mac-auth-0/#> mac match 00:80:C8:*  
or with wildcard, limit filter, and description ...  
mac-auth-0/#> mac match 00:D8:BB:C5:* limit 1/2 description "Laser printers on 1/2"
```

9.4 Feature Parameters

MAX_AUTH_CHAIN_METHODS	4
MAX_AUTH_CHAINS	3

Chapter 10

Ethernet Port Management

By default all ports on the switch are enabled. [Section 10.1](#) provides general information about the available port settings. [Section 10.2](#) covers port settings via the Web interface and [section 10.3](#) port settings via the CLI.

10.1 Overview of Ethernet Port Management

The table below presents available port settings. The features are presented further in the following sections.

Feature	Web	CLI	General Description
Enable/disable port	X	X	
Speed-duplex mode	X	X	Section 10.1.2
Flow control	X	X	Section 10.1.3
Port priority (level)	X	X	Section 10.1.4
Port priority mode	X	X	Section 10.1.4
Link alarm	X	X	Section 10.1.5
Inbound rate limit	X	X	Section 10.1.7
Rate Selection	X	X	-"
Traffic Selection		X	-"
Outbound traffic shaping	X	X	Section 10.1.8
Bandwidth per port	X	X	Section 10.1.9
MDI/MDIX	X	X	Section 10.1.10
Fastlink	(X)	(X)	Section 10.1.11

Continued on next page

Continued from previous page			
Feature	Web	CLI	General Description
Fallback default-VID		X	Section 10.1.12
VLAN filtering		X	Section 10.1.13
PHY fine tuning		X	
Shielded/Unshielded TP cable		X	
TX power mode		X	
View port configuration	X	X	
View port status	X	X	
View SFP DDM/DOM diagnostics	X	X	Section 10.1.14

10.1.1 Port naming conventions

The convention to name communication ports such as Ethernet ports, DSL ports, and Serial ports differs between WeOS products and product families.

10.1.1.1 Simple numbering

Lynx, Falcon, DDW-x42 (Wolverine), RedFox Industrial Rack, RedFox Rail, and Viper all use a simple *port ID* to refer to their ports.

- *Lynx*[57] and *RedFox Industrial Rack*[59]: Ethernet ports on Lynx and RedFox Industrial Rack are named 1, 2, 3, ...
- *Falcon*[52], *Lynx-DSS*[54] and some *Wolverine* units (e.g., *DDW-x42*[47]): These units have multiple port types; Ethernet, serial port(s) and xDSL/SHDSL (Falcon/Wolverine), which are numbered individually per port type. For example, Falcon is equipped with:
 - four Ethernet ports (numbered 1, 2, 3 and 4),
 - one xDSL port (numbered 1), and
 - one serial port (numbered 1).

As Ethernet and xDSL ports can be used in overlapping contexts, e.g., they can be associated with the same VLAN, a port *qualifier* ("**eth**" or "**dsl**") is sometimes used to distinguish Ethernet port 1 ("**eth 1**") from xDSL port 1 ("**dsl 1**").

- *RedFox Rail and Viper*: Ethernet ports on RedFox Rail and Viper are named X1, X2, X3, ...

10.1.1.2 Slot based numbering

RedFox Industrial[58] and some Wolverine products (DDW-225[50] and DDW-226[51]) use a slotted architecture, and ports are named according to the *slot ID* and the *port's position* within that slot. For example, port 1/2 would denote the second port in the first slot.

This name convention is used irrespective of port type, e.g., DDW-226 (Wolverine) has two SHDSL ports (1/1-1/2), 4 Ethernet ports (2/1-2/4), and one Serial port (1/1). Details on the name convention and the slotted architecture is described further below, using RedFox Industrial as example.

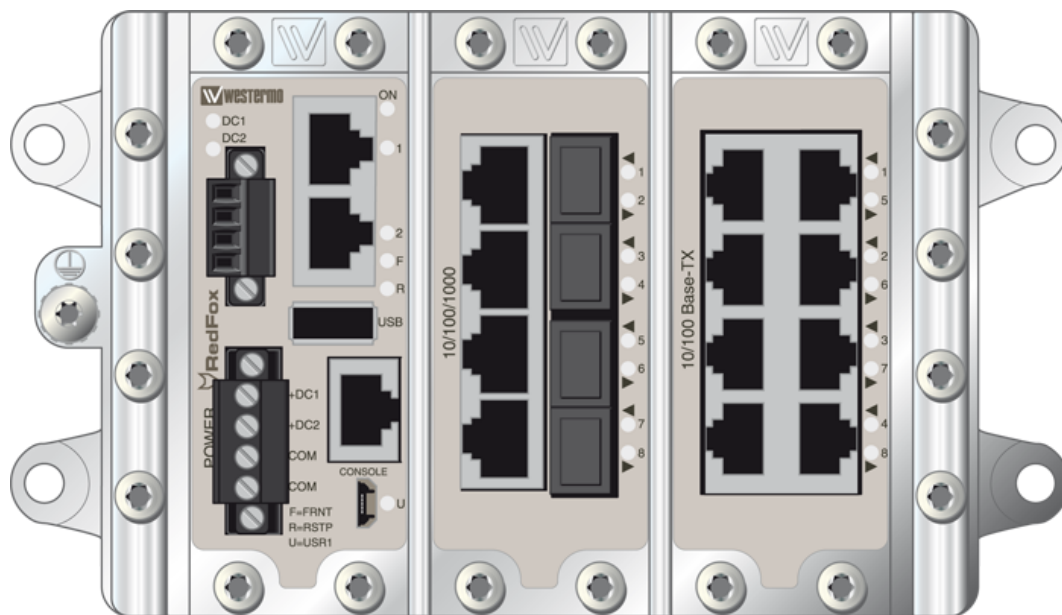

Figure 10.1: Three-slot RedFox Industrial switch equipped with a 8-port Giga-bit/SFP card (middle slot), and an 8-port 10/100BaseTX card (right slot).

The *RedFox Industrial* switches come in a two-slot and a three-slot version. [Fig. 10.1](#) shows a sample three-slot RedFox Industrial equipped with a 4-port Gigabit/SFP card (middle slot) and an 8-port 10/100BaseTX card (right slot). The leftmost slot contains the Power/CPU card, which is present on all RedFox Industrial switches.

RedFox Industrial makes use of a slotted architecture with different combinations

of interface modules. As mentioned above WeOS numbers the ports based on *slotID/portID*, where the

- the *slotID* denotes the slot's position within the rack (left to right), and
- the *portID* denotes the port's position within the slot (left to right, up to down).

For example, the three Ethernet ports in the leftmost slot (slot 1) are named *1/1* (top), *1/2* (middle), and *1/3* (bottom). The ports in the second slot are named *2/1-2/4* (left side) and *2/5-2/8* (right side), and ports in slot 3 are named *3/1-3/4* (left side) and *3/5-3/8* (right side).

10.1.2 Port speed and duplex modes

By default ports are configured to auto-negotiate speed (10/100/1000 Mbit/s) and duplex modes (half/full) to the "best" common mode when a link comes up. When configured for auto-negotiation, the resulting speed and duplex mode agreed is shown as part of the port status information.

For fixed copper ports, there are two additional possibilities to control the speed and duplex mode:

- It is possible to disable auto-negotiation and instead use a static speed and duplex mode setting. When using a static speed and duplex setting, the operator should ensure that the ports on both ends of the link are configured with the same static speed and duplex settings.
- When auto-negotiation is enabled, all available speed and duplex modes are advertised by default. However, it is possible to limit which modes to advertise. This can be useful if the peer nodes are using auto-negotiation and there is a wish to limit the speed. The example below limits the advertised modes to speed 10 Mbit/s on Ethernet port 3.

Example

```
example:/#> configure
example:/config/#> port eth 3
example:/config/port-eth3/#> speed-duplex auto
example:/config/port-eth3/#> auto-neg-capability 10-half,10-full
example:/config/port-eth3/#> leave
example:/#>
```

Depending on Ethernet port type, the available port speeds will differ:

- Fixed Copper Ports
 - Fast Ethernet copper ports: Fast Ethernet copper ports are capable of operating at 10 or 100 Mbit/s.
 - Gigabit Ethernet copper ports: Gigabit Ethernet copper ports are capable of operating at 10, 100 or 1000 Mbit/s.
- SFP Ports: SFP slots are typically cable to operate up to Gigabit speeds (10/100/1000), but some products have SFP slots limited to Fast Ethernet (10/100). See your product user guide ([section 1.5](#)) for references to available SFPs.
 - Fibre SFPs: Gigabit SFP slots can be used both with 100 Mbit/s and 1000 Mbit/s fibre SFPs. Please ensure that same type of SFP is used at both sides.
 - * When using 100 Mbit/s fibre SFPs, 100 Mbit/s full duplex will be used (no auto-negotiation).
 - * When using 1000 Mbit/s fibre SFPs, auto-negotiation is used advertising 1000 Mbit/s full duplex.
 - Copper SFPs: Copper SFPs will use auto-negotiation for speed-duplex configuration, i.e., it is not possible to set a fixed speed/duplex setting for copper SFPs.

10.1.3 Flow control

The ports can be configured to use *flow control*, i.e., to dynamically limit inbound traffic to avoid congestion on outbound ports.

When flow control is enabled on a *full duplex* port, the switch will send *pause frames* (IEEE 802.3x) to limit inbound traffic on this port, if that traffic is causing congestion when sent out on another switch port.

When flow control is enabled on a *half duplex* port, the switch will use a technique known as *back-pressure* to limit inbound traffic on this port, if that traffic is causing congestion when sent out on another switch port. (The *back-pressure* technique enables a switch to force its neighbour to slow down by sending *jamming signals* on that port, thus emulating a packet collision.)

10.1.4 Layer-2 priority support (CoS)

Each Ethernet port has four output queues, enabling layer-2 priority support with four traffic classes. Layer-2 priority is also referred to as *Class of Service (CoS)*. The queues are serviced according to *strict priority scheduling*, i.e., when there is traffic in multiple queues, the packets in the queue with higher priority is serviced first.

A packet's priority is determined when it enters on a port, and can be classified based on:

- **VLAN ID:** The switch can be configured to give specific priority to certain VLANs. This can be used, e.g., when providing IP telephony via a dedicated VLAN. Priority based on VLAN ID has precedence over all priority classifications described below.

VLAN ID priority settings are further described in [chapter 15](#).

- **VLAN tag:** For packets carrying a VLAN tag, the packet's priority can be based on content of the priority bits¹ inside the VLAN tag. The VLAN tag is useful to carry packet priority information on inter-switch links.

Use of VLAN tag priority can be configured per port (see [sections 10.2](#) and [10.3](#)).

- **IP ToS/DiffServ:** For IP packets the priority can be classified based on the content of the IP ToS bits (IPv4) or the IP TC bits (IPv6). Classification based on the IP ToS/Diffserv bits can be used to provide higher priority to delay sensitive applications, such as *IP telephony* and *remote login*, than to bulk data applications, such as *file transfer*. However, it requires that those applications can set the IP ToS/Diffserv bits appropriately.

Use of IP ToS/DiffServ priority can be configured per port (see [sections 10.2](#) and [10.3](#)).

- **Port Priority:** Priority can be classified based on the inbound port.

Use of port priority can be configured per port (see [sections 10.2](#) and [10.3](#)). Furthermore, when priority classification is configured to be based on VLAN tag (or IP ToS/DiffServ), priority will be based on the port priority for untagged (or non-IP respectively) packets.

When priority is classified based on VLAN ID, VLAN tag, or port priority, the priority assigned to a packet will take a value in range 0-7, and be represented by

¹This 3-bit priority field is also referred to as Priority Code Point (PCP).

3 bits (PCP field of IEEE 802.1p). The *default* mapping of PCP/802.1p priority (8 values) to traffic class (4 output queues) is shown in [table 10.2](#). The rationale behind this mapping is described in Annex G of IEEE 802.1Q-2005[22]. A *custom* PCP priority to queue mapping can be configured as described in [sections 8.2.5](#) (Web) and [8.3.35](#) (CLI).

IEEE 802.1p priority	Queue number/ Traffic Class
0	0 (lowest)
1	0
2	1
3	1
4	2
5	2
6	3
7	3 (highest)

Table 10.2: Default mapping of IEEE 802.1p/PCP priority to Queue/Traffic Class.

When priority is classified based on IP ToS/DiffServ, the priority assigned to a packet will take a value in range 0-63, and be represented by 6 bits (DSCP - Differentiated Services Code Point). The *default* mapping of DSCP priority (64 values) to traffic class (4 output queues) is shown in [table 10.3](#). This mapping is in line with the use of IP Precedence fields (RFC 1349), and IP DiffServ for *best effort* and *control* traffic (RFC 2474), *assured forwarding* (RFC 2597) and *expedited forwarding* (RFC 3246). A *custom* DSCP priority to queue mapping can be configured as described in [sections 8.2.5](#) (Web) and [8.3.35](#) (CLI).

IP Priority bits						IP Priority values	Queue bits		Queue number/ Traffic class
5	4	3	2	1	0		1	0	
0	0	-	-	-	-	0-15	0	0	0 (lowest)
0	1	-	-	-	-	16-31	0	1	1
1	0	-	-	-	-	32-47	1	0	2
1	1	-	-	-	-	48-63	1	1	3 (highest)

Table 10.3: Default mapping of IP priority bits (DSCP priority) to Queue/Traffic Class.

Packets sent out on a port *with* a VLAN tag will carry priority information (802.1p)

within their VLAN tag.

- For packets where priority was classified based on VLAN ID, VLAN tag, or port priority, the outbound priority (3 bits) will be equal to the determined inbound priority (3 bits).
- When priority is classified based on IP ToS/DiffServ, determining the outbound priority (3 bits) is more complex: the two most significant bits of the outbound priority will be equal to the queue number (i.e., queue bits in [table 10.3](#)), while the least significant bit of the outbound priority is equal to the least significant bit of the inbound port's configured port priority.

E.g., if the packet is put in priority queue 2 (binary '10'), and the port priority of the inbound port has an odd value (least significant bit is '1'), the packet will carry priority value 5 ('101') in its VLAN tag when sent on the outbound port.



Warning

Configuration of layer-2 priority should be handled with care. In particular, mapping user traffic to the highest priority queue is discouraged, since that may affect time critical control traffic, such as FRNT traffic, already mapped to the highest priority queue.

10.1.5 Link alarm

Each Ethernet port on the switch can be configured to indicate alarm when the link comes up or goes down. The alarm is indicated in multiple ways:

- *SNMP trap*: An SNMP trap will be sent when a link changes state, i.e., both when the link comes up, or when it goes down. This assumes that SNMP is enabled, and that a trap host is configured. See [chapter 6](#) for more information.
- *Front panel LEDs*: A link alarm may effect both the individual LED of the port, as well as the common status LED for the switch (for definite information about what functions affect the common status LED, see [chapter 25](#)):
 - *Individual LED*: Each Ethernet port has a LED, which generally indicates 'green' if the link is up. If there is no link, the LED will indicate 'yellow' when link alarm is configured.

- *Common status LED*: The switch has a common status LED, labelled 'ON' on the front panel. This LED will generally indicate 'green' if all associated functions are OK, and 'red' if one or more of the associated alarm sources are 'NOT OK'. E.g., if one of the ports configured with link alarm indicates link down, the common status LED will be 'red'.
- *Web interface*: Link alarms (link down) are indicated on the *main* Web page, and the *port configuration/status* page.
- *CLI*: A link alarm (link down) is indicated by an exclamation mark ('!') when displaying the port's status in the CLI.
- *Digital I/O*: A link alarm can affect the output level of the status relay in the same way as it will affect the common status LED.

For more information on the functionality of the Digital I/O port, see [chapter 25](#).

10.1.6 Automatic disable

Each enabled port on the switch can be configured to automatically be disabled when the link have been down for some time. The configured (admin) state of the port remains enabled but the operative state changes to down as soon as the automatic disable timer elapses. The timer is only started when the link goes down (or already is down). It is reset if the link is reestablished.

10.1.7 Inbound/Ingress rate limiting

The switch can be configured to limit the rate of a port's incoming traffic - *inbound rate limiting* (also referred to as *ingress rate limiting*). By default a port will accept packets at a rate up to the link speed, but with inbound rate limiting activated the switch will start dropping packets when data arrives above the given rate threshold.

The inbound rate limiting feature can be useful as a complement to layer-2 priority handling (see [section 10.1.4](#)) when congestion within the network is to be avoided.

There are two configuration settings for inbound rate limiting:

- *Rate*: Defines the threshold data rate. The web interface provides a predefined set of rates (drop-down list). The CLI allows for more fine-grained rate settings:

- in steps of 64 kbit/s in range 64-1000 kbit/s
- in steps of 1 Mbit/s in range 1-100 Mbit/s
- in steps of 10 Mbit/s in range 100-1000 Mbit/s (on Gigabit Ethernet ports.)

Rate limiting calculations consider the layer-2 bits, i.e., from Ethernet destination MAC address to CRC (interframe gap and preamble bits are not counted).

- *Traffic Type*: Defines the kind of traffic subject to inbound rate limiting. By default, a configured rate limit will apply to all traffic, however, it is possible to restrain the rate limit to specific (layer-2) traffic types: broadcast, multi-cast and/or unknown² unicast. As of WeOS v4.33.0 selection of traffic types can only be done via the CLI.

²Unknown unicast traffic is traffic with a unicast destination MAC address not present in the switch forwarding database (see [section 15.4.22](#)). Unknown unicast traffic is flooded onto all ports within the (V)LAN.

10.1.7.1 Restrictions on inbound rate limiting

On RedFox units, some of the interface modules have hardware dependent restrictions regarding the inbound rate limit function. These restrictions are described in this section.

Which Ethernet ports on RedFox have the restrictions described here?

The restrictions apply to Ethernet ports of MV88E6185 switchcores, used in RFI and RFIR products (but not RFR products):

- RedFox Industrial (RFI)[58]: Only Ethernet ports on modules "F4G" and "F4G-T4G" have these restrictions.
- RedFox Industrial Rack (RFIR)[59]: Only Ethernet ports in the 8-port group/module with Gbit/s ports (4 Gbit/s SFP and 4 Gbit/s Copper ports) have these restrictions.

Please see *Detailed System Overview* page in the Web ([section 4.4.2](#)) or use the "**show system-information**" in the CLI ([section 7.3.2](#)) to find *definite* information about what switchcore(s) is used in your product.

- *TCP traffic*: When the data rate rises above the given threshold on these Ethernet ports, packets will be dropped in a manner "punishing" TCP traffic relatively hard. Thus, activating inbound rate limiting applicable to unicast traffic may have an undesired impact on your TCP traffic,.
- *Traffic types*: When restricting the inbound rate limit to a certain traffic type (broadcast, multicast and/or unknown unicast) on these Ethernet ports, there are dependencies between the settings:
 - *Unknown unicast*: Selecting "unknown unicast" implies that "unknown unicast", "multicast" and "broadcast" traffic will be subject to inbound rate limiting.
 - *Multicast*: Selecting "multicast" implies that "multicast" and "broadcast" traffic will be subject to inbound rate limiting.
 - *Broadcast*: Selecting "broadcast" simply means that "broadcast" traffic will be subject to inbound rate limiting.
- *Upper bound for rate limiting*: Maximum rate limit on these Gigabit ports is 250 Mbit/s. Setting a higher rate limit (e.g., 300 Mbit/s) will result in a rate limit of 250 Mbit/s.

Due to these restrictions, it is recommended that *inbound rate limiting* is primarily used as a means of storm prevention, on the ports where these restrictions apply.

10.1.8 Outbound/Egress traffic shaping

The switch can be configured to limit the outbound data rate on a port (outbound traffic shaping). By default each port will send at the maximum speed of the link, but with outbound traffic shaping activated the switch will limit the outbound rate to a given threshold. Above that threshold the switch will buffer packets - *bursty* traffic will be *shaped*. In case the output buffer is full, additional packets destined for that port will be dropped.

When configuring the *threshold rate* for outbound traffic shaping, the same settings as for inbound rate limiting (see [section 10.1.7](#)) applies. For outbound traffic shaping it is also possible to specify rate in frames per second. The web interface provides a predefined set of rates (drop-down list). The CLI allows for more fine-grained rate settings:

- Bits per second:
 - in steps of 64 kbit/s in range 64-1000 kbit/s
 - in steps of 1 Mbit/s in range 1-100 Mbit/s
 - in steps of 10 Mbit/s in range 100-1000 Mbit/s (on Gigabit Ethernet ports)
- Frames per second: in range 7700-1488000 frames per second

Traffic shaping calculations consider the layer-2 bits, i.e., from Ethernet destination MAC address to CRC (interframe gap and preamble bits are not counted).



Note

Outbound traffic shaping in *frames per second* mode is available for Ethernet ports on all WeOS products, with exceptions for ports on some RedFox and RedFox Industrial Rack models. The Ethernet ports listed to have restrictions for ingress rate limiting (see [section 10.1.7.1](#)) also lack support for the *frames per second* mode.

Furthermore, outbound traffic shaping in *frames per second* mode is *not* available for DSL ports (ADSL/VDSL or SHDSL) ports.

10.1.9 Bandwidth per port

The switch can be configured to monitor the inbound and outbound bandwidth per port. By default this feature is disabled, but can be enabled for any Ethernet and DSL port. The bandwidth calculation is split into inbound and outbound traffic for the last 10 seconds, 1 minute, 10 minutes and 1 hour using moving average. These statistics are recalculated every 10 seconds.

10.1.10 MDI/MDIX crossover

By default a switch is able to sense which pin to use for reception and which to use for transmission (auto MDI/MDIX crossover), thus no external crossover cable is necessary. In addition, a port can be configured statically in MDI (Media Dependent Interface) or MDIX (crossover) mode.

10.1.11 Fastlink - Fast link-up/link-down on fixed 10/100 Ethernet copper ports

Default port settings in WeOS are aimed at being conformant and compatible with as many devices as possible. Therefore the ports are setup to auto-negotiate speed, duplex and automatically agree with the link partner on which end should cross RX and TX when a straight cable is used. Naturally this takes a bit of time, despite all current products today do this in dedicated PHY circuitry.

To speed things up considerably, a feature called "Fastlink" can be activated on fixed 10/100 Mbit/s Ethernet copper ports³. This feature basically disables any IEEE back-offs and timeouts in place to protect against glitches and temporary link loss that otherwise prevent the port from going UP or DOWN. Westermo has put a great deal of effort into making sure that, when enabling Fastlink, glitches and link loss still do *not* occur.

Enable Fastlink by configuring the port(s) with the following two settings:

- *Fixed* speed/duplex mode, preferably *100 Mbit full-duplex*. That is, auto-negotiation of speed/duplex mode is disabled. See [section 10.1.2](#) for information on port speed/duplex.
- *Fixed* MDI/MDIX crossover mode, i.e., auto-MDI/MDIX is disabled. See [section 10.1.10](#) for information on port crossover mode.

³Fastlink does not apply to Gigabit Ethernet ports, or to any SFP ports. Another exception is the specific 10/100 Mbit/s Ethernet ports on "Viper-12A/20A"[[63](#), [64](#), [65](#), [66](#)] attached to an MV88E6352 switchcore. Please see [section 4.4.2](#) (Web) or [section 7.3.2](#) (CLI) to find *definite* information about what switchcore(s) is used in your product.

In most use-cases auto-negotiation of speed-duplex and MDI/MDIX is still preferable, but enabling Fastlink can improve failover performance in some redundancy applications – we refer to this as the *fastlink* mode:

- RedFox Rail [60] bypass relay ports[60]: RedFox Rail routers equipped with a bypass relay are typically used in train backbones. The four backbone ports, two in each direction, are controlled by a relay, ensuring connectivity between routers on the backbone when one or more routers experience power-loss. The *fastlink* mode minimises disruption when the bypass relay changes state.
- Layer-2 redundancy: the *fastlink* mode can improve failover performance for various layer-2 redundancy mechanisms, e.g., when using static link aggregation (section 20).

**Note**

The *fastlink* mode requires more precise knowledge of cabling and devices used because all automatic detection is disabled. E.g., on the RedFox Rail[60] bypass relay ports, make sure to setup 100 Mbps Full-Duplex, with MDI/MDIX mode set to either:

- MDIX in both directions and crossover cables between switches, or
- MDI in one direction, MDIX in the other, with a straight cable

The latter case does however not work when a train car is turned 180°, but may be useful in other setups since straight cables are more commonplace.

10.1.12 Fallback default VID

The fallback default VLAN ID is generally unnecessary to configure.

The purpose of the fallback default-VID is to control what should happen with "untagged" packets entering a port only configured "tagged" on a set of VLANs. For more information on VLAN features and the VLAN related terms used throughout this section, see [chapter 15](#).

Every port needs to have a "default VID". The default VID specifies the VLAN ID an "untagged" packet should be associated with as it enters that port. A port's default VID is determined as follows:

- If a port is associated "untagged" with a VLAN, that VID will be the port's default VID. E.g., if a port is associated "untagged" to VID 10, the port will

have VID 10 as its "default VID".

- If a port is *not* associated "untagged" with any VLAN, the port's default VID is determined as:
 - the port's fallback default VID, given that a fallback default-VID is configured, or
 - the default VLAN (VID 1), if no fallback default-VID is configured

The fallback default VID can be used to control whether "untagged" packets should be accepted on a port (only) associated "tagged" with a set of VLANs. If the port's default VID is represented within that set of VLANs, the packet will be accepted. Otherwise it will be dropped.

10.1.13 VLAN Filtering

By default the switch filters ingress traffic on a port based on its VLAN memberships. Untagged traffic on a port that only is tagged member will be assigned the VLAN in the (fallback) default-vid setting before being passed to the VLAN filtering stage.

IEEE 802.1Q VLAN filtering can be disabled per port, or per VLAN in which case filtering is disabled only for untagged ports. When disabled a Q-in-Q VLAN tunnel can be set up between endpoints in a LAN, e.g. when tunneling one or more sets of VLANs through a shared topology. See [section 15.1.9](#) for more information.

10.1.14 SFP DDM/DOM Diagnostics

Digital diagnostics monitoring (DDM), also known as digital optics monitoring (DOM), is a function enabling the user to monitor diagnostic parameters of the SFP.

WeOS provides diagnostic information for the following DDM parameters.

- Optical TX power
Measures the optic power when transmitting, which can be used for detecting a deteriorating link⁴. The accuracy is better than +/-3dB and the total range of -40 to +8.2 dBm (0–6.5535 mW).

⁴By comparing the TxPower on a unit with the RxPower on the unit it is connected to, the user can find out the amount of "signal strength" that is lost over the optic link. When the gap between TxPower and RxPower is increasing, the optic link's capability to transfer the signal decreases.

- **Optical RX power**
Measures the optic power when receiving, which can be used for detecting a deteriorating link. The accuracy is better than +/-3dB and the total range of -40 to +8.2 dBm (0–6.5535 mW).
- **Temperature**
The temperature of the SFP should be very close or equal to the temperature of the unit. The temperature accuracy is better than 3 degrees Celsius (°C) and the total range of -128 °C to +128 °C.
- **Bias current**
The transmitting bias current can be used to determine how fast an SFP is aging. The accuracy is better than +/- 10% and the total range of 0 - 131 mA.
- **Voltage** The voltage should always be 3.3V since the SFP's power supply line is the same as the unit. The accuracy is better than +/-3% and the total range of 0–6.55 V.

DDM/DOM information will only be listed for enabled ports.



Note

DDM support in WeOS is limited to Westermo DDM SFPs, see the SFP Transceiver Datasheet of your WeOS product (www.westermo.com).

10.2 Managing port settings via the web interface

10.2.1 List Port Settings

Menu path: Configuration ⇒ Port ⇒ Port

When entering the port configuration page you will be presented to a list of all ports available on your switch, see [fig. 10.2](#). Here you get an overview of the settings for all ports, and in addition two items of dynamic information - alarms and link status.

Port Configuration

Port	Enabled	Link	Type	Speed/Duplex	Link Alarm Enabled	
1/1	✓	Up	Fast Ethernet	Auto	☐	
1/2	✓	Up	Fast Ethernet	Auto	☐	
2/1	✓	Up	Fast Ethernet	Auto	☐	
2/2	✓	Down	Fast Ethernet	Auto	✓	
2/3	✓	Down	Fast Ethernet	Auto	✓	
2/4	✓	Down	Fast Ethernet	Auto	✓	
2/5	✓	Up	Fast Ethernet	Auto	☐	
2/6	✓	Down	Fast Ethernet	Auto	☐	
2/7	☐	Down	Fast Ethernet	Auto	☐	
2/8	☐	Down	Fast Ethernet	Auto	☐	

Figure 10.2: Port configuration settings overview (this example is from a RedFox Industrial switch)

Alarm	There is an active link alarm associated with the port. Only shown if link alarm is enabled and the link is down.
Port	The port label
Enabled	Shows if the port is enable or disabled
Auto Disable	Activate the port disable timer functionality
Link	Link status for the port. Up or down.
Continued on next page	

Continued from previous page	
Type	The port type: Gigabit Ethernet Fibre optic, Gigabit Ethernet, Fast Ethernet Fibre optic or Fast Ethernet.
Speed/Duplex	The speed duplex setting. Auto means speed and duplex will be automatically negotiated. Otherwise the current setting will be shown as speed in Megabit and duplex as FDX for full duplex and HDX for half duplex. Note! This is not the negotiated speed, it is the configuration setting!
Link Alarm Enabled	When link alarm is enabled an alarm will be generated if port link is down. Alarms trigger an SNMP trap message to be sent and alarms to be shown on the administration web. In the ports overview table a green check-mark means enabled, and a dash means disabled.
 Edit	Click this icon to edit a port's settings.

To change the settings for a specific port you will have to click the edit icon which will take you to the port setting edit page see [section 10.2.2](#).

10.2.2 Edit Port Settings

Menu path: Configuration ⇒ Port ⇒ Port ⇒ 

Port X3

On this page you can change the settings for the port.

Type	The port type: Gigabit Ethernet Fibre optic, Gigabit Ethernet, Fast Ethernet Fibre optic or Fast Ethernet.
Enable	Enable/disabled the port
Auto Disable	Automatic disable of port with no link
Speed/Duplex	The speed duplex setting. Auto means speed and duplex will be automatically negotiated. Otherwise the current setting will be shown as speed in Megabit and duplex as FDX for full duplex and HDX for half duplex. Note! This is not the negotiated speed, it is the configuration setting!
Auto-negotiation Capabilities	Select which Speed/Duplex modes to auto-negotiate. Only applicable for fixed copper ports (no SFP ports), and only when Speed/Duplex is set to 'Auto'. Default: All modes.
Continued on next page	

Continued from previous page	
MDIX mode	How to handle crossover cables. If you connect two units with different port settings (one with mdi and one with mdix) you need a straight-through twisted pair cabling. If you connect two units with the same setting you will need a crossover cabling. Auto Automatic detection mdi Medium dependent interface mdix mdi crossover
Priority Mode	Here you select on what information priority will be based: Port Based Based on the port's priority. See the next item (Priority). IP Based on the content of the IP ToS bits (IPv4) or the IP TC bits (IPv6). VLAN Tag Based on the content of the (802.1p) priority field inside the received packet's VLAN tag.
Priority	The port's priority level. Zero (0) is low priority and seven (7) high priority.
Inbound Rate Limit	Bandwidth limit for inbound traffic. <i>Disabled</i> means no limiting.
Inbound Rate Limit Match	Traffic type to limit on inbound. All Any traffic. Bc Broadcast traffic. Mc Multicast traffic. Unk. Uni Unknown Unicast traffic.
Outbound Traffic Shape	Bandwidth limit for outbound traffic. <i>Disabled</i> means no limiting.
Bandwidth Statistics	Enable or disable bandwidth monitoring per port. See Section 11.2.2 for how to view the statistics that is gathered when this function is enabled.
Link Alarm	When link alarm is enabled an alarm will be generated if port link is down. Alarms trigger an SNMP trap message to be sent and alarms to be shown on the administration web.

10.2.3 List SFP DDM/DOM diagnostics

For information on how to view SFP DDM/DOM diagnostics, see [section 4.4.3](#).

10.3 Managing port settings via the CLI

The *port* configuration context can be entered using the "**port** <PORT|PORTLIST>" command from the *Global Configuration* context. When providing a list of ports, the scope of the configuration commands becomes all ports in the list. There is also a specific command, "**ports**", to enter the port context with the scope of *all Ethernet ports* of the device.

Command	Default	Section
port [eth . . .] <PORTLIST>	Ethernet	Section 10.3.1
ports [eth . . .]	Ethernet	Section 10.3.2
[no] enable [timeout SEC]	Enabled	Section 10.3.3
[no] speed-duplex <auto 10-half 10-full 100-half 100-full 1000-half 1000-full>	auto	Section 10.3.4
[no] auto-neg-capability <10-half,10-full, 100-half,100-full,1000-half,1000-full>	All	Section 10.3.5
[no] flow-control	Disabled	Section 10.3.6
[no] priority <0-7>	0	Section 10.3.7
[no] priority-mode <tag ip port>	tag	Section 10.3.8
[no] link-alarm	Disabled	Section 10.3.9
[no] rate-limit <64-1000000> [match <TYPE>[,<TYPE>,...]]	Disabled	Section 10.3.10
[no] traffic-shaping <<64-1000000> <7700-1488000> fps>	Disabled	Section 10.3.11
[no] bandwidth-statistics	Disabled	Section 10.3.12
[no] mdix-mode <auto mdi mdix>	auto	Section 10.3.13
[no] unshielded	Unshielded	Section 10.3.14
[no] low-power	Low Power	Section 10.3.15
[no] default-vid <VLAN_ID>	Disabled	Section 10.3.16
<u>Show port status</u>		
show port [full] [PORTLIST]	All	Section 10.3.18
<u>Show SFP DDM/DOM diagnostics</u>		
show environment		Section 7.3.44

10.3.1 Managing Ports

Syntax `port [eth|...] <PORT|PORTLIST>`

The **"port"** command is used for many port types, thus the full command syntax is

"port [eth|dsl|shdsl|xdsl|serial] <PORT|PORTLIST>".

Context [Global Configuration](#) context

Usage Enter Port Configuration context of the given PORT (or PORTLIST) and port type.

A **"PORTLIST"** is a comma separated list of ranges of ports without intermediate spaces, e.g., **"1/1,1/2"** on a *slotted* product, or **"1-3,5"** on a *non-slotted* product.

The port qualifier keyword **"eth|..."** is not needed if the numbers in the **"PORTLIST"** are unique to a single type of port. If there are multiple port with the same number (but different types), the port qualifier is needed, e.g., **"port eth 1"** and **"port dsl 1"**.

For information on using the **"port"** command to enter:

- [xDSL Port Configuration](#) context, see [section 13.3.1](#).
- [SHDSL Port Configuration](#) context, see [section 12.3.1](#).
- Serial port context, see [section 40.3.1](#).

Use **"show port [eth|...] [PORT|PORTLIST]"** to list port configuration information on one or more ports. Also available as **"show"** command within the Port Configuration.

Default values Not applicable for configuration. For listing configuration **"show port"** information on all ports are listed by default.

Entering port configuration context for Ethernet ports 1-4:

 **Example**

```
example:/config/#> port 1-4
example:/config/port-eth1-4/#>
```

This unit has two ports with number 1 (**"eth 1"** and **"dsl 1"**) thus the port qualifier is needed to determine which port to configure:

Example

```
example:/config/#> port 1
Ambiguous or bad port range or port type: 1
example:/config/#> port dsl 1
example:/config/port-dsl1/#>
```

10.3.2 Managing all Ports

Syntax ports [eth|dsl|shdsl|xdsl|serial]

Context Global Configuration context

Usage Enter Port Configuration context with the scope of all ports of a specific type (Ethernet, xDSL, etc.).

Default values "Ethernet" for *configuration* (i.e., "ports" will enter Ethernet Port Configuration for all Ethernet ports), and "All" for *showing configuration* (i.e., "show ports") will list information on all port types).

Listing information on all ports.

Example

```
example:/config/#> show ports
Ethernet ----- Priority ---- Limit - Default
Port  Ena Aneg Speed  DPX  Flow  MDI/X  Alarm  Mode Level  In | Out  Vid
=====
Eth 1  YES  YES  ---  -    NO    auto   NO  tag    0  None None  Auto
Eth 2  YES  YES  ---  -    NO    auto   NO  tag    0  None None  Auto
Eth 3  YES  YES  ---  -    NO    auto   NO  tag    0  None None  Auto
Eth 4  YES  YES  ---  -    NO    auto   NO  tag    0  None None  Auto
=====
xDSL ----- Priority ---- Limit - Default
Port  Ena Mode Filter Encap PVC  Annex Alarm  Mode Level  In | Out  Vid
=====
DSL 1  YES adsl  YES  llc 8/35  A    NO  tag    0  None None  Auto
=====
Serial ----- Data ----- Stop RTS XON -----
Port  Ena Type  Speed  bits Parity  bits CTS XOFF Terminate
=====
Ser 1  YES rs232  115200 8  None  1  OFF OFF  N/A
=====
example:/config/#>
```

Listing information on a all ports of a specific type

 **Example**

```
example:/config/#> show ports dsl
xDSL ----- Priority ---- Limit - Default
Port  Ena Mode Filter Encap PVC  Annex Alarm Mode Level  In | Out  Vid
=====
DSL 1  YES adsl  YES  llc 8/35  A   NO  tag    0  None None  Auto
=====
example:/config/#>
```

10.3.3 Port enabling and disabling

Syntax [no] enable [timeout SEC]

Context [Ethernet Port Configuration](#) context (also available in [SHDSL Port Configuration](#) and [xDSL Port Configuration](#) for products with DSL ports)

Usage Use **"enable"** to enable and **"no enable"** disable a port.

An optional **"timeout SEC"** can be configured to limit the time, in seconds, a port is accessible (without link) before it is disabled. To re-enable such a disabled port, either reboot the device, or use the [Admin Exec "port up PORT"](#) command to temporarily enable it again.

Use **"show enable"** to show whether the port is enabled, disabled, or temporarily enabled (with timeout).

Default values Ports are enabled by default.

10.3.4 Speed and duplex setting

Syntax [no] speed-duplex <auto|10-half|10-full|100-half|100-full|1000-half|1000-full>

Context [Ethernet Port Configuration](#) context.

Usage Set port speed and duplex modes. **"auto"** means auto-negotiate, other modes are static configurations specifying 10, 100 or 1000 Mbit/s, and half or full duplex.

"no speed-duplex" will revert to default configuration for the speed-duplex setting, i.e., **"speed-duplex auto"**.

Use **"show speed-duplex"** to show the port's speed/duplex setting.

Default values auto

Error messages An attempt to set a port speed not available for this specific port type will render an error message, including information of available port speeds.

10.3.5 Auto-negotiate capability setting

Syntax [no] auto-neg-capability <10-half,10-full,100-half,100-full,1000-half,1000-full>

Context Ethernet Port Configuration context. (Only applicable for fixed copper ports)

Usage Set port speed and duplex modes to advertise when auto-negotiate is enabled, i.e., if **"speed-duplex auto"** is set for this port.

"no auto-neg-capability" will revert to default configuration, i.e., to advertise all modes applicable for this port.

Use **"show auto-neg-capabilities"** to show the port's auto-negotiate capability setting.

Default values All (all modes applicable for the type of Ethernet port)

Example

```
example:/#> configure
example:/config/#> port 3
example:/config/port-eth3/#> speed-duplex auto
example:/config/port-eth3/#> auto-neg-capability 10-half,10-full
example:/config/port-eth3/#> leave
example:/#> show port eth 3
Eth 3
-----
Link           : UP
Admin status   : Enabled
Oper. status   : Enabled
Link changes   : 15
Type           : 10/100TX
Autoneg        : Enabled (10-half,10-full)
Speed          : 10M
Duplex         : Full
State          : Forwarding
...
...
example:/#>
```

10.3.6 Flow-control setting

Syntax [no] flow-control

Context [Ethernet Port Configuration](#) context.

Usage Enable or disable IEEE 802.3 flow-control. For full duplex links, flow control will utilise IEEE 802.3 *pause frames*, and for half duplex links a technique known as *back-pressure* is used.

The flow control setting is only valid when the speed-duplex mode is set to "auto", see [section 10.1.2](#).

Use "**show flow-control**" to show the port's flow-control setting.

Default values Disabled (no flow-control)

10.3.7 Port priority setting

Syntax [no] priority <0-7>

Context [Ethernet Port Configuration](#) context (also available in [SHDSL Port Configuration](#) and [xDSL Port Configuration](#) for products with DSL ports)

Usage Set the (IEEE 802.1p) priority associated with the port. Packets coming in on this port will receive this priority unless priority is based on VLAN ID, VLAN tag or IP ToS/DiffServ bits.

"no priority" will revert to default configuration for the port priority setting, i.e., "priority 0" (zero).

Use "**show priority**" to show the port's priority setting.

Default values 0 (zero)

10.3.8 Set port priority mode

Syntax [no] priority-mode <tag|ip|port>

Context [Ethernet Port Configuration](#) context (also available in [SHDSL Port Configuration](#) and [xDSL Port Configuration](#) for products with DSL ports)

Usage Base priority classification for this port on content of VLAN tag (IEEE 802.1p priority bits), content of IP ToS/Diffserv bits, or the port priority configured for this port.

Note

VLAN priority settings (see [section 15.4](#)) will have precedence over port priority mode settings.

tag (Default) The packet's priority is based on the content of the VLAN tag (802.1p priority bits) of the incoming packet. For packets coming in *untagged*, the priority is based on the priority associated with the port, see [section 10.3.7](#).

ip The packet's priority is based on the content of the IP ToS/Diffserv bit of the incoming packet. For non-IP packets coming in on the port (e.g., ARP packets), the priority is based on the priority associated with the port, see [section 10.3.7](#).

port The packet's priority is based on the priority associated with the port, see [section 10.3.7](#).

Use "**show priority-mode**" to show the port's "priority mode" setting.

Default values tag

10.3.9 Link alarm

Syntax [no] link-alarm

Context [Ethernet Port Configuration](#) context (also available in [SHDSL Port Configuration](#) and [xDSL Port Configuration](#) for products with DSL ports)

Usage Use "**link-alarm**" to enable and "**no link-alarm**" disable link-alarm for this port. Link alarms are part of WeOS alarm handling system ([chapter 25](#)). The "**link-alarm**" command is a short-cut to create and enable/disable a *link-alarm trigger*. Please see [section 25.3.2.1](#) for more CLI settings related to link-alarm triggers.

"**show link-alarm**" to show the port's link-alarm setting.

Default values Disabled ("**no link-alarm**")

10.3.10 Inbound rate limiting

Syntax [no] rate-limit <64-1000000> [match <TYPE>[,<TYPE>,...]]

Context [Ethernet Port Configuration](#) context (also available in [SHDSL Port Configuration](#) and [xDSL Port Configuration](#) for products with DSL ports)

Usage Configure inbound rate limit in kbit/s. It is also possible use ISO modifiers k/M/G, e.g., 256k or 10M as specifiers for kbit/s and Mbit/s.

 **Note**
| Set values are rounded off to the nearest possible HW setting.

Optionally packet TYPE may be specified using one or more of the specifiers **"all"** (all types), **"bc"** (broadcast), **"mc"** (multicast) or **"u-uni"** (unknown unicast) in any combination. If no TYPE is specified (or if the specifier **"all"** is given) all packets will be rate limited.

 **Note**
| All WeOS products except RedFox and RedFox Industrial Rack support any combination of types. As stated in [section 10.1.7.1](#), the traffic type selection on RedFox and RedFox Industrial Rack implicitly adds **"bc"** if **"mc"** is specified, and adds both **"bc,mc"** if **"u-uni"** is specified.

Use **"no rate-limit"** to disable inbound rate limiting.

Use **"show rate-limit"** to show the port's inbound rate limit setting.

Default values Disabled (**"no rate-limit"**)

10.3.11 Outbound traffic shaping

Syntax [no] traffic-shaping <<64-1000000>|<7700-1488000> fps>

Context [Ethernet Port Configuration](#) context (also available in [SHDSL Port Configuration](#) and [xDSL Port Configuration](#) for products with DSL ports, albeit not fps)

Usage Configure outbound traffic shaping in kbit/s or frames per second. It is also possible use ISO modifiers k/M/G, e.g., 256k or 10M as specifiers for kbit/s and Mbit/s.

 **Note**
| Set values are rounded off to the nearest possible HW setting.

Use **"no traffic-shaping"** to disable outbound traffic shaping.

Use **"show traffic-shaping"** to show the port's outbound traffic shaping setting.

Default values Disabled (**"no traffic-shaping"**)

10.3.12 Bandwidth statistics

Syntax [no] bandwidth-statistics

Context [Ethernet Port Configuration](#) context (also available in [SHDSL Port Configuration](#) and [xDSL Port Configuration](#) for products with DSL ports)

Usage Use **"bandwidth-statistics"** to enable and **"no bandwidth-statistics"** to disable bandwidth-statistics for this port. When enabled, bandwidth monitoring for inbound and outbound traffic is calculated.

"show bandwidth-statistics" to show whether monitoring is enabled or disabled.

Please see [Section 11.3.5](#) for how to view the statistics that is gathered when this function is enabled.

Default values Disabled (**"no bandwidth-statistics"**)

10.3.13 Cable crossover setting

Syntax [no] mdix-mode <auto|mdi|mdix>

Context [Ethernet Port Configuration](#) context.

Usage Configuration of Cable Crossover setting. **"auto"** means automatic crossover mode, **"mdix"** sets port to crossover mode (MDIX) and **"mdi"** sets port to MDI mode. This command is not valid for *fib*re ports.

"no mdix-mode" resets the MDIX mode to the default setting (**"auto"**).

Use **"show mdix-mode"** to show the port's cable crossover setting.

Default values auto.

10.3.14 Adapting PHY Receiver to Shielded or Unshielded Cable

Syntax [no] shielded

Context Ethernet Port Configuration context.

Usage Fine tune the PHY receiver to the cable characteristics of shielded or unshielded TP cables. This setting applies to 10/100 Base-TX ports, excluding SFP/SFF ports as well as ports also capable of 1000 Mbit/s speeds.

Use **"shielded"** to adapt the PHY receiver to the use of shielded TP cables. Use **"no shielded"** to adapt the PHY receiver to the use of unshielded TP cables.

 **Note**

This setting is only expected to be used by customers with special requirements - the default setting should be sufficient for most use cases.

Use **"show shielded"** to show the port's "shielded" setting.

Default values Unshielded (no shielded).

10.3.15 Enable/disable Low Power Mode on TX Data Signalling

Syntax [no] low-power

Context Ethernet Port Configuration context.

Usage It possible to select between two signal power modes on the Ethernet data signalling pins for 10/100 Base-TX ports. (This setting applies to 10/100 Base-TX ports, excluding SFP/SFF ports as well as ports also capable of 1000 Mbit/s speeds.)

The *low-power* mode is sufficient in most use cases, but for long cables or cables with specific characteristics it may be necessary to *disable low-power mode*.

Use **"low-power"** and **"no low-power"** respectively to enable/disable low-power mode on this Ethernet port.

 **Note**

This setting is only expected to be used by customers with special requirements - the default setting should be sufficient for most use cases.

Use **"show low-power"** to show whether the PHY (TX Data Signalling) low-power mode is enabled or disabled.

Default values Low-Power (low-power).

10.3.16 Fallback default VLAN

Syntax [no] default-vid <VLAN_ID>

Context [Ethernet Port Configuration](#) context (also available in [SHDSL Port Configuration](#) and [xDSL Port Configuration](#) for products with DSL ports)

Usage Configuration of (fallback) default-VID for this port. The default-VID configuration is only valid when this port is not configured "untagged" on any VLAN.

Use **"no default-vid"** to clear the (fallback) default VID setting (the default-VID setting will also be cleared whenever the port is associated "untagged" with any VLAN).

When cleared (**"no default-vid"**), VLAN ID 1 will be used as the port's fallback default-VID.

This setting in combination with [section 10.3.17](#) can be used to set up Q-in-Q VLAN tunneling.

For more information see [section 10.1.12](#).

Use **"show default-vid"** to show the port's "fallback default-VID" setting.

Default values Disabled/cleared (no default-vid).

10.3.17 VLAN Filtering

Syntax [no] dot1q

Context [Ethernet Port Configuration](#) context (also available in [SHDSL Port Configuration](#) and [xDSL Port Configuration](#) for products with DSL ports)

Usage Configuration of IEEE 802.1Q VLAN filtering for this port.

Disabling IEEE 802.1Q VLAN filtering for a port means all ingressing traffic will be assigned the VLAN specified in the port's default-vid setting. This can be used to set up Q-in-Q VLAN tunneling.

For more information see [section 10.1.12](#).

Use **"show dot1q"** to show the port's current setting.

Default values Enabled.

10.3.18 Show port status

Syntax show port [full] [PORTLIST]

Context Admin Exec context

Usage Show Port status information for all ports or a set of ports. Without arguments (**"show port"**) will provide summary information on status all ports.

"show port full" can be used to provide detailed status information about all ports.

By adding a port list (e.g., **"show port eth 1-3"**, detailed status information will be provided for the given subset of ports.

Default values All (i.e., without a PORTLIST, information for all ports will be provided)

Listing summary status information on all ports.

 **Example**

```
example:/#> show port
Ethernet
-----
Port      Link Type           Speed      State      Alarm  VID  MAC Address
=====
Eth 1     UP 1000TX-SFP      1000M-Full Forwarding N/A    1   00:07:7c:61:e5:21
Eth 2     UP 100FX            100M-Full  Forwarding N/A    1   00:07:7c:61:e5:22
Eth 3     UP 10/100TX         100M-Full  Forwarding N/A    1   00:07:7c:61:e5:23
Eth 4     DOWN 10/100TX         -----   -----   N/A    1   00:07:7c:61:e5:24
Eth 5     DOWN 10/100TX         -----   -----   N/A    1   00:07:7c:61:e5:25
Eth 6     DOWN 10/100TX         -----   -----   N/A    1   00:07:7c:61:e5:26
Eth 7     DOWN 10/100TX         -----   -----   N/A    1   00:07:7c:61:e5:27
Eth 8     DOWN 10/100TX         -----   -----   N/A    1   00:07:7c:61:e5:28
Eth 9     UP 10/100TX         100M-Full  Forwarding N/A    1   00:07:7c:61:e5:29
Eth 10    DOWN 10/100TX         -----   -----   N/A    1   00:07:7c:61:e5:2a
=====
Speed formatted as, e.g., 100-Full is for static speed-duplex links.
example:/#>
```

Listing detailed information on a subset of ports (here Ethernet 3).

Example

```
example:/#> show port eth 3
Eth 3
-----
Link           : UP
Admin status   : Enabled
Oper. status   : Enabled
Link changes   : 3
Type           : 10/100TX
Autoneg        : Enabled (10-half,10-full,100-half,100-full)
Speed          : 100M
Duplex         : Full
State          : Forwarding
Alarm          : N/A
VLAN ID        : 1
MAC            : 00:07:7c:61:e5:23
Flow control   : Disabled
MDI/MDIX       : PolNorm
Prio mode      : tag
Prio           : 0
Ingress limit  : 0 match all
Egress limit   : 0 kbps
Shielded mode  : Unshielded
PHY power mode : Low power (CLASS B)
example:/#>
```

Chapter 11

Ethernet Statistics

A set of per port Ethernet statistic counters are available via the Web and via the CLI. Most of these counters correspond to standard SNMP MIB Ethernet statistics counters from the RMON MIB (RFC 2819), the Interface MIB (RFC 2863) and the Ether-Like MIB (RFC 3635). For more information about WeOS SNMP support, see [chapter 6](#).

[Section 11.1](#) gives a general introduction to the Ethernet statistic counters available via Web and CLI. [Sections 11.2](#) and [11.3](#) present use of Ethernet statistics via the Web and CLI respectively.

11.1 Ethernet Statistics Overview

The table below provides a summary of the available Ethernet statistics counters. [Sections 11.1.1-11.1.8](#) give more detailed information on their meaning.

Feature	Web	CLI	Description
<u>Inbound</u>			
Total Bytes	X	(X) ²	Section 11.1.1
Bytes Good		X	-"-
Bytes Bad		X	-"-
Mean rate		X	-"-
Total Good Packets		(X) ²	Section 11.1.2
Unicast	X	X	-"-
Multicast	X	X	-"-
Continued on next page			

Continued from previous page			
Feature	Web	CLI	Description
Broadcast	X	X	-"-
Pause frames		X	-"-
Size statistics	X		-"-
Dropped	X	X	Section 11.1.3
Filtered		X	-"-
Discarded		X	-"-
Erroneous		(X) ²	Section 11.1.4
Undersize	X	X	-"-
Oversize	X	X	-"-
Fragments	X	X	-"-
Jabber	X	X	-"-
Checksum	X	X	-"-
PHY Error		X	-"-
Bandwidth Statistics	X	X	Section 11.1.9
10 second average	X	X	-"-
1 minute average	X	X	-"-
10 minute average	X	X	-"-
1 hour average	X	X	-"-
<u>Outbound</u>			
Total Bytes	X	X	Section 11.1.5
Mean rate		X	"
Total Packets	(X) ²	(X) ²	Section 11.1.6
Unicast	X	X	-"-
Multicast	X	X	-"-
Broadcast	X	X	-"-
Pause frames		X	-"-
Dropped			Section 11.1.7
Filtered		X	-"-
Collisions and Busy Medium	X	(X) ²	Section 11.1.8
Single		X	-"-
Multiple		X	-"-
Excessive		X	-"-
Late	X	X	-"-

Continued on next page

Continued from previous page			
Feature	Web	CLI	Description
Other collisions		X	"-"
Deferred		X	"-"
Bandwidth Statistics	X	X	Section 11.1.9
10 second average	X	X	"-"
1 minute average	X	X	"-"
10 minute average	X	X	"-"
1 hour average	X	X	"-"

11.1.1 Inbound Byte Counters

A set of byte counters (i.e., octet counters) are provided. The number of *good* bytes is also used to compute a rough estimation of the current inbound data rate.

Bytes Good The number of *good bytes/octets* received on a port, i.e., the sum of the length of all good Ethernet frames received.

Bytes Bad The number of *bad bytes/octets* received on a port, i.e., the sum of the length of all bad Ethernet frames received.

Total Bytes The sum of good and bad bytes received on a port (see above). This would correspond to the RMON MIB *etherStatsOctets* and the Interface MIB *ifHCInOctets* objects.

Mean Rate Rough estimation of the current data rate based on the number of good bytes received during a time interval (2 seconds).

11.1.2 Inbound Counters of Good Packets

The following per port counters for *good* inbound Ethernet packets are provided.

Unicast packets The number of *good* packets with a unicast MAC address received on the port.

This would correspond to the Interface MIB *ifInUcastPkts* object.

Multicast packets The number of *good* packets with a group MAC address (excluding broadcast) received on the port.

²Counters listed within parenthesis (i.e., as '(X)') are provided implicitly.

This would correspond to the RMON MIB *etherStatsMulticastPkts* and the Interface MIB *ifInMulticastPkts* objects, except that *Pause frames* (see below) are not included.

Broadcast packets The number of *good* packets with a broadcast MAC address received on the port.

This would correspond to the RMON MIB *etherStatsBroadcastPkts* and the Interface MIB *ifInBroadcastPkts* objects.

Pause Frames The number of *good* flow control packets received.

Packet Size Statistics Counters for good Ethernet packet of the following size intervals are provided: 64 bytes, 65-127 bytes, 128-255 bytes, 256-511 bytes, 512-1023 bytes, and 1024-MAXPKTSIZE bytes, where MAXPKTSIZE is 1632.

These size intervals match the corresponding RMON statistics counters, except for the MAXPKTSIZE (1632 instead of 1518).

11.1.3 Dropped Inbound Packets

Counters for two types of dropped inbound packets are provided. Note, these packets are *good* Ethernet packets, but are dropped due to the reasons given below.

Filtered Inbound packets dropped due to VLAN mismatch or because the port was in LEARNING, LISTENING or BLOCKING state.

Discarded Packets dropped due to lack of buffer space.

11.1.4 Erroneous Inbound Packets

The following counters for received erroneous packets are provided:

Undersized packet Number of packets smaller than 64 bytes, and with a valid FCS.

This corresponds to the RMON MIB *etherStatsUndersizePkts* object.

Oversized packet Number of packets larger than 1632 bytes, and with a valid FCS.

This corresponds to the RMON MIB *etherStatsOversizePkts* object, except for the used MAXPKTSIZE (1632 instead of 1518 bytes).

Fragmented packet Number of packets smaller than 64 bytes, with an *invalid* FCS.
This corresponds to the RMON MIB *etherStatsFragments* object.

Jabber Number of packets larger than 1632 bytes, and with an *invalid* FCS.
This corresponds to the RMON MIB *etherStatsJabbers* object, except for the used MAXPKTSIZE (1632 instead of 1518 bytes).

Checksum/FCS Error Packets of valid length (64-1632), but with an incorrect FCS.
This corresponds to the RMON MIB *etherStatsCRCAAlignErrors* object, except for the used MAXPKTSIZE (1632 instead of 1518 bytes).

PHY Error Signal Number of received packets generating a *receive error* signal from the Ethernet PHY. (Referred to as *InMacRcvErr* in the CLI port statistics list)

11.1.5 Outbound Byte Counters

A single outbound byte/octet counter, **Outbound Bytes**, is provided. It represents the sum of the length of all Ethernet frames sent on the port. This would correspond to the Interface MIB *ifHCOctets* object.

The number of **Outbound bytes** is also used to calculate a rough estimation of the current sending data rate (**Mean Rate**, i.e., the number of bytes sent during a time interval (2 seconds)).

11.1.6 Outbound Packets Counters

The following per port counters for outbound Ethernet packets are provided.

Unicast packets The number of packets with a unicast destination MAC address sent on the port.

This would correspond to the Interface MIB *ifOutUcastPkts* object.

Multicast packets The number of packets with a group destination MAC address (excluding broadcast) sent on the port.

This would correspond to the Interface MIB *ifOutMulticastPkts* objects, except that *Pause frames* (see below) are not included.

Broadcast packets The number of packets with a broadcast destination MAC address sent on the port.

This would correspond to the Interface MIB *ifOutBroadcastPkts* objects.

Pause Frames The number of flow control packets sent.

11.1.7 Dropped Outbound Packets

The counter for a single type of dropped outbound packets is described here (there is also a second kind, see *excessive collisions* in [section 11.1.8](#)).

Filtered Outbound packets dropped outbound policy rules or because the port was in LEARNING, LISTENING or BLOCKING state.

11.1.8 Outbound Collision and Busy Medium Counters

The collision and busy medium counters described here are only relevant for half-duplex links.

Single Collisions The number of packets involved in a single collision, but then sent successfully.

This would correspond to the Ether-like MIB *dot3StatsSingleCollisionFrames* object.

Multiple Collisions The number of packets involved in more than one collision, but finally sent successfully.

This would correspond to the Ether-like MIB *dot3StatsMultipleCollisionFrames* object.

Excessive Collisions The number of packets failing (i.e., dropped) due to excessive collisions (16 consecutive collisions).

This would correspond to the Ether-like MIB *dot3StatsExcessiveCollisions* object.

Late Collisions The number of collisions detected later than a *512-bits time* into the packet transmission.

This would correspond to the Ether-like MIB *dot3StatsLateCollisions* object.

Other Collisions Other collisions than *single*, *multiple*, *excessive* or *late* collisions discovered on a port.

Total Collisions Computed as the sum of *single*, *multiple*, *excessive*, *late* and *other* collisions.

Deferred (busy medium) The number of packets experiencing a busy medium on its first transmission attempt, and which is later sent successfully, and without experiencing any collision.

This would correspond to the Ether-like MIB *dot3StatsDeferredTransmissions* object.

11.1.9 Inbound and outbound bandwidth statistics

The bandwidth statistics counters are described here. These counters need to be enabled to give any statistics data. This is configured per port. Please see [Section 10.3.12](#) for CLI and [Section 10.2.2](#) for web.

The counters are split into inbound and outbound traffic and shown as bits, kbits, Mbits or Gbits per second.

10 second average The average bandwidth over the last 10 seconds.

1 minute average The average bandwidth over the last minute.

10 minute average The average bandwidth over the last 10 minutes.

1 hour average The average bandwidth over the last hour.

11.2 Statistics via the web interface

Statistics shown in the web administration tool has two views. An *overview* with a selection of statistics for all ports, including some status information (e.g. if port is blocking or forwarding), and a *detailed* page with a larger set of statistics.

Note that collection of statistics is started by the first access to the statistics page, and will be halted after a short period of time (to save resources) if no one requests the statistic data. This has the effect that you may need to enter the page once again, by e.g. clicking the menu item, to ensure you are presented to updated statistics data.

11.2.1 Statistics Overview

Menu path: Status⇒Port

On the port statistics overview page you will be presented to a selection of static data for each port. Additional statistic numbers are presented on the detailed view page.



Port Status and Statistics

Port	Link	State	Speed / Duplex	Total Bytes In	Total Bytes Out	FCS Errors	Details
1/1	Up	FORWARDING	100 FDX	111435680	304967	0	
1/2	Up	BLOCKING	100 FDX	113430677	1275	0	
2/1	Down	DISABLED		0	0	0	
2/2	Down	DISABLED		0	0	0	
2/3	Down	DISABLED		0	0	0	
2/4	Down	DISABLED		0	0	0	
3/1	Down	DISABLED		1676	1292	0	
3/2	Down	DISABLED		0	0	0	
3/3	Up	FORWARDING	100 FDX	0	1700512	0	
3/4	Up	BLOCKING	100 HDX	135413162	10530	4	
3/5	Down	DISABLED		0	0	0	
3/6	Down	DISABLED		0	0	0	
3/7	Down	DISABLED		0	0	0	
3/8	Down	DISABLED		0	0	0	

Auto refresh: Off, 5s, 15s, 30s, 60s

Refresh

Clear All

 Alarm	An alarm icon appears at the start of a line if there is a link alarm on a port.
Port	The port label.
Link	The status of the link. Up or down.
State	<p>FORWARDING Unit forwards packets. Normal operation.</p> <p>LEARNING The port is preparing itself for entering FORWARDING state.</p> <p>BLOCKING Unit does not forward any packets.</p> <p>DISABLED Port does not participate in operation.</p>
Speed / Duplex	The current speed and duplex negotiated or set on the port.
Total Bytes In	Total number of bytes received on the port.
Total Bytes Out	Total number of bytes sent out on the port.
FCS Errors	Total number of inbound packets with check sum error received on the port.
 Details	Click this icon to view more detailed statistics for the port.
Auto Refresh	Click on a value to make the page reload with updated statistics automatically every 5, 15, 30 or 60 seconds. Click Off to turn off auto refresh.
Refresh	Click on this button to reload with updated statistics.
Clear All	Clear all statistics counters for all ports.

11.2.2 Detailed Statistics

Menu path: Status ⇒ Port ⇒ 

When clicking the *details*-icon in the overview page you will be presented to the detailed statistics page for the port.

Port Status and Statistics - Port 3/1

Link Status	Up
-------------	----

Traffic Counters		
	Inbound	Outbound
Total Bytes	2480840	4685690
Broadcast Packets	1091	1080
Multicast Packets	14515	49783
Unicast Packets	4	6
Dropped Packets	0	

Errors, Inbound		Traffic Size, Inbound	
Type	Packets	Octets	Packets
Fragments	0	64	47
Oversize	0	65 -> 127	331
Undersize	0	128 -> 255	14714
Jabber	0	256 -> 511	518
Frame Checksum	0	512 -> 1023	0
		1024 -> Max	0

Errors, Outbound	
Type	Packets
Total Collisions	0
Single Collisions	0
Multiple Collisions	0
Excessive Collisions	0
Late Collisions	0
Other Collisions	0
Deferred	0
Filtered	0

Bandwidth Statistics		
Time scale	Inbound	Outbound
10 second average	0.0 bit/s	164.0 bit/s
1 minute average	40.0 bit/s	101.0 bit/s
10 minute average	50.0 bit/s	92.0 bit/s
1 hour average	50.0 bit/s	89.0 bit/s

Auto-Refresh: Off, 5s, 15s, 30s, 60s

Link Status	Status of link (Up/Down). If a link-alarm is associated with this port, an alarm icon is displayed if the link-alarm is active.
Total Bytes	Total number of bytes received (inbound) or transmitted (outbound) on this port.
Broadcast Packets	Total number of good broadcast packets received (inbound) or transmitted (outbound) on this port.
Multicast Packets	Total number of good multicast packets received (inbound) or transmitted (outbound) on this port.
Unicast Packets	Total number of good unicast packets received (inbound) or transmitted (outbound) on this port.
Dropped Packets	Total number of packets received that have been discarded.
Fragments	Total number of fragmented packets received on this port.
Oversize	Total number of oversized packets received on this port.
Undersize	Total number of undersized, but otherwise well formed, packets received on this port.
Jabber	Total number of packets received on this port larger than the network segment's maximum transfer unit (MTU).
Frame Checksum	Total number of packets received on this port with checksum error.
Traffic Size, Inbound	Number of octets received in different size categories.
Total Collisions	Total number of collisions detected on this port (sum of <i>single</i> , <i>multiple</i> , <i>excessive</i> , <i>late</i> , and <i>other</i> collision counters).
Single Collisions	The number of packets involved in a single collision, but then sent successfully.
Multiple Collisions	The number of packets involved in more than one collision, but finally sent successfully.
Excessive Collisions	The number of packets failing (i.e., dropped) due to excessive collisions (16 consecutive collisions).
Continued on next page	

Continued from previous page	
Late Collisions	The number of collisions detected later than a <i>512-bits time</i> into the packet transmission.
Other collisions	Other collisions than <i>single, multiple, excessive</i> or <i>late</i> collisions discovered on a port.
Deferred	The number of packets experiencing a busy medium on its first transmission attempt, and which is later sent successfully, and without experiencing any collision.
Filtered	Outbound packets dropped outbound policy rules or because the port was in LEARNING, LISTENING or BLOCKING state.
Bandwidth Statistics	Shows bandwidth statistics for the port in different time scales. Note that you must enable bandwidth statistics for the port in order to see any data here. See Section 10.2.2 .
Auto Refresh	Click on a value to make the page reload with updated statistics automatically every 5, 15, 30 or 60 seconds. Click Off to turn off auto refresh.
«Previous	Goto statistics for previous port.
Next»	Goto statistics for next port.
Refresh	Click on this button to reload with updated statistics.
Clear Port	Clear all statistics counters for the port shown.

11.3 Statistics via the CLI

The table below shows statistic features available via the CLI.

Command	Default	Section
rmon		Section 11.3.1
statistics [PORT]		Section 11.3.2
clear-stats [PORT]		Section 11.3.3
show rmon [PORT]		Section 11.3.4
show port bandwidth [PORT]		Section 11.3.5

11.3.1 Managing Ethernet Statistics

Syntax rmon

Context [Admin Exec](#) context

Usage Enter RMON Statistics context. WeOS starts gathering statistics when this command is issued, thus there is a 2 seconds delay before the RMON context is entered.

Default values Not applicable.

11.3.2 List Current Ethernet Statistics

Syntax statistics [PORT]

Context [RMON Statistics](#) context

Usage Show Ethernet statistics. If no PORT is given ("**statistics**", a summary of statistics for all Ethernet ports is presented.

If a PORT is given as argument (e.g., "**statistics 1/1**") detailed statistics for that port is presented.

For information about what the different statistics counters represent, see [section 11.1](#).

Default values If no PORT argument is given, a summary of statistics for all Ethernet ports is presented.

11.3.3 Clear Ethernet Statistics

Syntax clear-stats [PORT]

Context [RMON Statistics](#) context

Usage Clear Ethernet statistic counters. If no PORT is given ("**clear-stats**", counters for all Ethernet ports are cleared.

If a PORT is given as argument (e.g., "**clear-stats 1/1**") the counters for that port are cleared.

Default values If no PORT argument is given, counters for all Ethernet ports are cleared.

11.3.4 Show Ethernet Statistics

Syntax show rmon [PORT]

Context [Admin Exec](#) context. Also available as "**show [PORT]**" command within the [RMON Statistics](#) context.

Usage Show Ethernet statistics. This command provides the same information as the "**statistics**" command ([section 11.3.2](#)). The only difference is that the "**show rmon [PORT]**" command is available from the [Admin Exec](#) context.

If no PORT is given ("**show rmon**"), a summary of statistics for all Ethernet ports is presented.

If a PORT is given as argument (e.g., "**show rmon 1/1**") detailed statistics for that port is presented.

For information about what the different statistics counters represent, see [section 11.1](#).

Default values If no PORT argument is given, a summary of statistics for all Ethernet ports is presented.

11.3.5 Show port bandwidth statistics

Syntax show port bandwidth [PORT]

Context [Admin Exec](#) context.

Usage Show port bandwidth statistics for the port.

If no PORT is given ("**show port bandwidth**"), bandwidth statistics is shown for all ports.

If a PORT is given as argument (e.g., "**show port bandwidth 1/1**") bandwidth statistics for that port is presented.

Note that you must enable bandwidth statistics for the port in order to see any data here. See [Section 10.3.12](#).

Default values If no PORT argument is given, bandwidth statistics for all ports is presented.

Chapter 12

SHDSL Port Management

Wolverine family switches (DDW225/DDW-226/DDW-x42/DDW-x42-485¹) are equipped with two SHDSL ports (Symmetric High-speed Digital Subscriber Line), enabling LAN networks to be extended over legacy copper cabling.

12.1 Overview of SHDSL Port Management

12.1.1 SHDSL overview

With SHDSL Ethernet LANs can be extended over legacy copper cabling. Switches can be connected in a simple point-to-point setup, but also in multi-drop and ring topologies, as shown in [fig. 12.1](#).

In a SHDSL connection, the port on one unit shall be configured as *Central Office* (CO) and the port on the other unit as Customer Premises Equipment (CPE). SHDSL ports are named according to the name convention described in [section 10.1.1](#)). By default 1/1 or DSL 1 is configured as *CPE* while the 1/2 (or DSL 2) is configured as *CO*.

SHDSL support in WeOS is based on *Ethernet First Mile* (EFM) technology, and SHDSL can to a large extent be treated in the same way as Ethernet ports, e.g., you can add SHDSL ports to VLANs ([chapter 15](#)), you can run link-layer redundancy protocols such as FRNT ([chapter 16](#)) and RSTP ([chapter 18](#)) over them, etc. Settings specific to SHDSL ports are described in [section 12.1.2](#) while port settings of more general nature is covered in [section 12.1.3](#).

¹DDW-x42 refers to DDW-142 and DDW-242 products. DDW-x42-485 refers to DDW-142-485 and DDW-242-485 products.

Feature	Web	CLI	General Description
CO/CPE mode selection	X	X	Section 12.1.1-12.1.2
DSL link rate	X	X	Section 12.1.1-12.1.2
DSL noise margin	X	X	Section 12.1.1-12.1.2
G.HS threshold	X	X	Section 12.1.2
PAF	X	X	Section 12.1.2
Low-Jitter	X	X	Section 12.1.2
EMF	X	X	Section 12.1.2
Settings in common with Ethernet ports			
Enable/disable port	X	X	Section 12.1.3
Port priority (level)	X	X	Section 12.1.3
Port priority mode	X	X	Section 12.1.3
Link alarm	X	X	Section 12.1.3
Inbound rate limit	X	X	Section 12.1.3
Outbound traffic shaping	X	X	Section 12.1.3
Bandwidth Statistics	X	X	Section 12.1.3
Fall-back default-VID		X	Section 12.1.3
View DSL port configuration	X	X	
View DSL port status	X	X	

12.1.2 Settings specific to SHDSL ports

- **Port role:** One unit shall be configured as *Central Office* (CO) and the other unit as *Customer Premises Equipment* (CPE). CO is the answering central unit. CPE (Customer Premises Equipment) is the unit that initiates the connection. In WeOS the SHDSL ports are named *1/1* and *1/2* in products with slot based numbering and *DSL 1* and *DSL 2* in products with simple port numbering: by default *1/1* (or *DSL 1*) is configured as *CPE* and *1/2* or *DSL 2* configured as *CO*.
- **Data rate:** For a *regular* SHDSL connection, data rates can be achieved in the range from 192 kbit/s up to 5696 kbit/s depending on cable characteristics and communication distance. For products supporting *turbo-SHDSL*, data rates from 32 kbit/s up to 15304 kbit/s are possible. When using PAF in DDW-x42 (and DDW-x42-485), data rates up to 30608 kbit/s are possible.

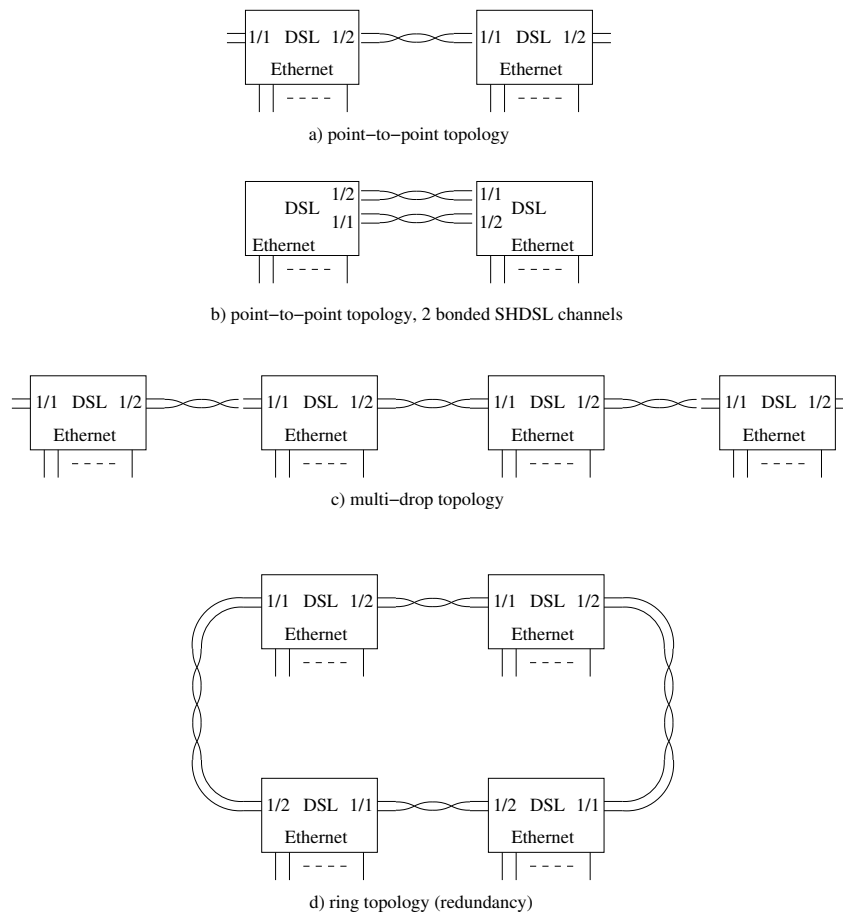

Figure 12.1: SHDSL topologies: Point-to-point (a), point-to-point, 2 bonded SHDSL channels (b), multi-drop (c) and ring (d).

Products with Turbo-speed support

Turbo-speed is supported on *all DDW-226* and *DDW-x42/DDW-x42-485 devices*, and on all but the earliest DDW-225 devices. To see if your DDW-225 unit supports turbo-speed SHDSL, inspect its article number, either by reading its attached label, or remotely by viewing the **"Status ⇒ System"** Web page or by using the **"show system-information"** command in the CLI. If the article number says "3642-0230" the product lacks turbo-speed support. If it says "3642-0250", the product supports turbo-speed.

Turbo-speed data rates can only be achieved if the SHDSL devices at both ends of the connection have turbo-speed support.

The operator can either specify a fixed data rate to be used, or let the CO and CPE discover the achievable data rate automatically.

Using *Auto* mode will optimise the data rate for the current SNR conditions.

- *Noise margin*: The noise margin is the difference between the required SNR for a certain bit rate, and the actual SNR.

When the SHDSL connection data rate is set to auto-negotiation mode, the operator can configure an *administrative noise margin* (also referred to as *target noise margin* or *target SNR margin*). A large *administrative noise margin* gives robustness against SNR fluctuations. But as the *required SNR* increases with data rate, specifying a large *administrative noise margin* may imply that a low data rate is negotiated.

Thus, when configuring the *administrative noise margin* the operator can optimise the connection for *reliability* (noise margin 10dB), *high speed* (noise margin 3dB) or as a tradeoff thereof (*normal* mode, i.e., noise margin 6dB).

To monitor the quality of the connection, WeOS enables the operator to read the *current noise margin*.

- *G.HS Threshold*: The G.HS threshold setting is only needed if the units are located in a noisy environment with SHDSL line cables of good quality, and where a connection can not even be established at SHDSL rate 192kbit/s. The setting configures a higher threshold of the G.HS idle parameter in order to detect idle. The SHDSL line length capability will be affected, since the G.HS idle threshold and the G.HS signals meet earlier when the G.HS Threshold is raised.

When enabling GHS threshold, possible settings include 'low(750)', 'medium (1500)', 'high(3000)' and a custom configured value.

Corresponding values to the fixed value settings are [low-750; medium-1500; high-3000]. The custom configured value could be set in the range [0-32767] in steps of 1.

- *PAF - PME Aggregation Function*: PAF functionality is used to aggregate the 2 SHDSL ports on DDW-x42 (and DDW-x42-485) to achieve higher bandwidth. The 2 "bonded" ports can reach rates from 64 kbit/s to 30,6 Mbit/s.
- *Low Jitter function*: Low Jitter is a SHDSL port specific function that can be used in applications where high accuracy of the Ethernet packet jitter is needed. If enabled the jitter of the latency over the SHDSL link will be minimized.

This functionality is using a different SHDSL mode compared to default setting, thus the Low Jitter configuration must be set on both SHDSL ports sharing the physical cable.

- *EMF - Emergency Freeze function:* EMF enabled makes the unit detect exception situations on the SHDSL links. The detection will freeze the SHDSL transceiver parameters temporarily to keep the link up. With this function enabled the unit might avoid a complete SHDSL retrain that could take up to a minute. The unit may lose data even with EMF enabled, but only for a short period of time.

**Note**

Only the data rate and noise margin settings of the CO are used in the SHDSL connection. These parameters are passed to the CPE during the connection establishment phase.

12.1.3 General port settings

The following parameters can be configured for SHDSL ports in the same way as for Ethernet ports. The SHDSL uses Ethernet First Mile (EFM) encapsulation, thus many Ethernet settings apply to the SHDSL ports. More detailed information is found in [chapter 10](#).

- *Port enable/disable:* Ports can be disabled and enabled administratively.
- *Port priority mode:* Define whether incoming packets should be prioritised based on VLAN tag, VLAN ID, port ID, IP ToS, etc. See also [section 10.1.4](#).
- *Port priority (level):* The inbound priority associated with this port. See also [section 10.1.4](#).
- *Link alarm:* Link status can be configured as an alarm source. See also [section 10.1.5](#).
- *Inbound rate limit:* Setting the inbound rate limit is possible on DSL ports, but is likely of less interest than on Ethernet ports, since the DSL data rates are primarily limited by the rate of the DSL line. See also [sections 10.1.7](#) and [12.1.2](#).
- *Outbound traffic shaping:* Setting the outbound rate limit (traffic shaping) is possible on DSL ports, but is likely of less interest than on Ethernet ports, since the DSL data rates are primarily limited by the rate of the DSL line.

Furthermore, outbound traffic shaping in *frames per second* mode is not available on DSL ports. See also [sections 10.1.8](#) and [12.1.2](#).

- *Bandwidth Statistics*: Enable or disable bandwidth statistics per port. See also [section 10.1.9](#).
- *Fall-back default-VID*: The fall-back default VID setting is only of interest for the special case when *untagged* packets are received over a link only associated with *tagged* VLANs.

Ethernet settings for *port speed/duplex* mode, and *MDI/MDIX* mode do not apply to SHDSL ports, thus are not configurable.



Note

As of WeOS v4.33.0, enabling/disabling flow control (as described in [section 10.1.3](#)) has no effect on SHDSL ports.

12.2 Managing SHDSL ports via the web interface

The Web interface provides configuration of SHDSL ports as well as listing of SHDSL port statistics.



The SHDSL statistics is provided in two views – an *overview* with a selection of statistics for all SHDSL ports, including some status information, and a *detailed* page with a larger set of statistics.

12.2.1 List and Edit SHDSL Port Settings

Menu path: Configuration ⇒ Port ⇒ SHDSL

SHDSL Configuration

Bonding (PAF)

Port	Enabled	CO/CPE	DSL Rate	Mode	Link Alarm Enabled	Advanced Settings
1	<input checked="" type="checkbox"/>	CO	Auto	Normal	<input type="checkbox"/>	
2	<input checked="" type="checkbox"/>	CO	Auto	Normal	<input type="checkbox"/>	

On this page you can list and change the settings for the SHDSL ports.

PAF	PAF aggregates the 2 SHDSL ports to achieve higher bandwidth. The functionality demands that the rate do not differ more the 4 times between port 1 and 2 to ensure good performance. Note: This functionality is only available on DDW-x42 and DDW-x42-485. Check to enable, un-check to disable. Default is Disabled .
Port	The SHDSL port label.
CO/CPE	To establish a connection between two DSL-ports, one has to be configured as Central Office (CO) and one has to be configured as Customer Premises Equipment (CPE). Default for port 1/1 is <i>CPE</i> , and default for port 1/2 is <i>CO</i> .
Continued on next page	

Continued from previous page	
DSL Rate	Speed setting is only valid if the port is configured as CO (the CPE rate setting is not used, since the CPE speed automatically follows the CO to which it becomes connected). See section 12.1.2 for information on using SHDSL-turbo speed data rates. Default is Auto .
Mode	The <i>noise-margin mode</i> . The <i>noise-margin mode</i> setting is only valid if the port is configured as CO (the CPE setting is not used, since the CPE <i>noise-margin mode</i> automatically follows the CO to which it becomes connected). The CO can be configured to choose a faster less reliable speed (High Speed), a slower more reliable speed (Reliable), or a tradeoff between these two objectives (Normal). Default is Normal .
Link Alarm	When link alarm is enabled an alarm will be generated if port link is down. Alarms trigger an SNMP trap message to be sent and alarms to be shown on the administration web.
 Edit	Click this icon to edit a port's settings.

12.2.2 Edit Port Settings

Menu path: Configuration ⇒ Port ⇒ SHDSL ⇒ PortNo ⇒ 

SHDSL Port 1/1

G.HS Threshold	Disable
Low Jitter	<input type="checkbox"/>
Link fault forwarding	<input type="checkbox"/>
Emergency Freeze	<input checked="" type="checkbox"/>
Priority Mode	VLAN Tag
Port Priority	0
Inbound Rate Limit	Disabled
Outbound Traffic Shape	Disabled
Bandwidth Statistics	<input type="checkbox"/>

On this page you can change the settings for the port.

G.HS Threshold	<p>The G.HS Threshold setting is only needed if the unit are located in a noisy environment with SHDSL line cables of good quality and where a connection can not even be established at SHDSL rate 192kbit/s. The setting configures a higher threshold of the G.HS idle parameter in order to detect idle. The SHDSL line length capability will be affected, since the G.HS idle threshold and the G.HS signals meet earlier when the G.HS Threshold is raised.</p> <p>When enabling G.HS Threshold, possible settings include 'low', 'medium' and 'high'.</p> <p>Corresponding values to the fixed value settings are [low-750; medium-1500; high-3000]</p> <p>If a custom value is configured in CLI, it will be displayed in the drop-down list.</p> <p>Default is Disabled</p>
Continued on next page	

Continued from previous page	
Low Jitter	<p>The Low Jitter mode can be enabled to minimize the jitter of the latency over the SHDSL link in applications where high accuracy of the Ethernet packet jitter is needed. This functionality is using a different SHDSL mode compared to default setting, thus the Low Jitter configuration must be set on both SHDSL ports sharing the physical cable. Check to enable, un-check to disable.</p> <p>Notice: Make sure that you have both line partners configured enabled or disabled.</p> <p>Default is Disabled.</p>
Link Fault Forward (LFF)	<p>On devices with SHDSL ports, alarms can be triggered when the remote SHDSL switch indicates it has link down on its Ethernet port. That is, this feature can be used in topologies where an Ethernet is extended over an SHDSL link, and where the remote SHDSL switch (e.g. a DDW-120) is able to signal that the Ethernet link is down on its side.</p> <p>Check to enable, un-check to disable.</p> <p>Default is Disabled.</p>
Emergency Freeze EMF	<p>EMF enabled makes the unit detect exception situations on the SHDSL links. The detection will freeze the SHDSL transceiver parameters temporarily to keep the link up. With this function enabled the unit might avoid a complete SHDSL retrain that could take up to a minute. The unit may lose data even with this functionality enabled, but only for a short period of time.</p> <p>Check to enable, un-check to disable.</p> <p>Default is Enabled.</p>
Priority Mode	<p>Here you select on what information priority will be based:</p> <ul style="list-style-type: none"> Port Based Based on the port's priority. See the next item (Priority). IP Based on the content of the IP ToS bits (IPv4) or the IP TC bits (IPv6). VLAN Tag Based on the content of the (802.1p) priority field inside the received packet's VLAN tag.
Continued on next page	

Continued from previous page	
Priority	The port's priority level. Zero (0) is low priority and seven (7) high priority.
Inbound Rate Limit	Bandwidth limit for inbound traffic. <i>Disabled</i> means no limiting.
Outbound Traffic Shape	Bandwidth limit for outbound traffic. <i>Disabled</i> means no limiting.
Bandwidth Statistics	Enable or disable bandwidth monitoring per port. See Section 11.2.2 for how to view the statistics that is gathered when this function is enabled.

12.2.3 SHDSL statistics Overview

Menu path: Status ⇒ Port ⇒ SHDSL

On the SHDSL port statistics overview page you will be presented to a selection of static data for each port. Additional statistic numbers are presented on the detailed view page.

SHDSL Statistics

Port	Negotiation State	State	Data Rate	Total Bytes In	Total Bytes Out	Details
1/1	UP_DATA_MODE	FORWARDING	5696000	234523	16412	
1/2	UP_DATA_MODE	FORWARDING	5696000	4266	73573	

Auto refresh: Off, 5s, 15s, 30s, 60s

Alarm	An alarm icon appears at the start of a line if there is a link alarm on a port.
Port	The port label. If PAF is configured, the background color of the port identifier is pink
Negotiation State	Current state of the DSL-line negotiation. Possible values are UP_DATA_MODE, INITIALISING, DOWN_READY and DOWN_NOT_READY. Note: if no link is established the normal state for a CO-mode configured port is DOWN_NOT_READY, for a CPE-configured port the normal state is DOWN_READY.
State	<p>FORWARDING Unit forwards packets. Normal operation.</p> <p>LEARNING The port is preparing itself for entering FORWARDING state.</p> <p>BLOCKING Unit does not forward any packets.</p> <p>DISABLED Port does not participate in operation.</p>
Data Rate	Negotiated DSL data rate in bit/s.
Total Bytes In	Total number of bytes received on the port.
Total Bytes Out	Total number of bytes sent out on the port.
Details	Click this icon to view more detailed statistics for the port.
Auto Refresh	Click on a value to make the page reload with updated statistics automatically every 5, 15, 30 or 60 seconds. Click Off to turn off auto refresh.
Refresh	Click on this button to reload with updated statistics.

12.2.4 Detailed SHDSL Port Statistics

Menu path: Status ⇒ Port ⇒ SHDSL ⇒ 

When clicking the *details*-icon in the overview page you will be presented to the detailed statistics page for the SHDSL port.

SHDSL Statistics - Port 1/1

Link Status	Up
Link Uptime	0 Days 0 Hours 8 Mins 3 Secs
Negotiation State	UP_DATA_MODE
Data Rate	5696000
Current SNR Margin (dB)	20
Negotiations	1

Traffic Counters	Inbound	Outbound
Total Bytes	683056	669286
Broadcast Packets	28	8
Multicast Packets	9996	9811
Unicast Packets	0	0
Dropped Packets	67	

Traffic Size, Inbound	Packets
Octets	
64	67
65 -> 127	9941
128 -> 255	17
256 -> 511	0
512 -> 1023	0
1024 -> Max	0

Auto refresh: Off, [5s](#), [15s](#), [30s](#), [60s](#)

Link Status	Status of link, (Up/Down). If a link-alarm is associated with this port, an alarm icon is displayed if the link-alarm is active.
Link Uptime	The time since link was established.
Continued on next page	

Continued from previous page	
Negotiation State	Current state of the DSL-line negotiation. Possible values are UP_DATA_MODE, INITIALISING, DOWN_READY and DOWN_NOT_READY. Note: if no link is established the normal state for a CO-mode configured port is DOWN_NOT_READY, for a CPE-configured port the normal state is DOWN_READY.
Data Rate	Negotiated DSL data rate in bit/s.
Current SNR Margin	Signal to Noise Ratio in dB on this link.
Negotiations	Number of negotiations since unit startup.
Total Bytes	Total number of bytes received (inbound) or transmitted (outbound) on this port.
Broadcast Packets	Total number of good broadcast packets received (inbound) or transmitted (outbound) on this port.
Multicast Packets	Total number of good multicast packets received (inbound) or transmitted (outbound) on this port.
Unicast Packets	Total number of good unicast packets received (inbound) or transmitted (outbound) on this port.
Dropped Packets	Total number of packets received that have been discarded.
Traffic Size, Inbound	Number of octets received in different size categories.
Auto Refresh	Click on a value to make the page reload with updated statistics automatically every 5, 15, 30 or 60 seconds. Click Off to turn off auto refresh.
<<Previous	Goto statistics for previous port.
Next>>	Goto statistics for next port.
Refresh	Click on this button to reload with updated statistics.
Clear Port	Clear all statistics counters for the port shown.

12.3 Managing SHDSL ports via the CLI

The table below shows SHDSL port management features available via the CLI.

Command	Default	Section
<u>Configure SHDSL port settings</u>		
port [dsl shdsl . . .] <PORTLIST>		Section 12.3.1
[no] co		Section 12.3.2
[no] speed <auto auto-5696k 0-15304k>	Auto	Section 12.3.3
[no] noise-margin	Normal	Section 12.3.4
[no] ghs-threshold <low medium high>	Disabled	Section 12.3.5
[no] paf	Disabled	Section 12.3.6
[no] low-jitter	Disabled	Section 12.3.7
[no] emf	Enabled	Section 12.3.8
<u>Port settings in common with Ethernet ports (chapter 10)</u>		
[no] enable	Enabled	Section 10.3.3
[no] priority <0-7>	0	Section 10.3.7
[no] priority-mode <tag ip port>	tag	Section 10.3.8
[no] link-alarm	Disabled	Section 10.3.9
[no] rate-limit <70-2560>	Disabled	Section 10.3.10
[no] traffic-shaping <70-2560>	Disabled	Section 10.3.11
[no] bandwidth-statistics	Disabled	Section 10.3.12
[no] default-vid <VLAN_ID>	Disabled	Section 10.3.16
<u>Show SHDSL related status and statistics</u>		
show <dsl shdsl>		Section 12.3.9
show ports		Section 10.3.18
show rmon		Section 11.3

12.3.1 Managing SHDSL port settings

Syntax port [dsl|shdsl|. . .] <PORTLIST>

Context Global Configuration context

Usage Enter the SHDSL Port Configuration context.

A **"PORTLIST"** is a comma separated list of ranges of SHDSL ports without intermediate spaces, e.g., **"1/1,1/2"** on a *slotted* product, or **"1-3,5"** on a *non-slotted* product.

The port qualifier keyword **"shdsl"** (or **"dsl"**) is not needed if the numbers in the **"PORTLIST"** are unique to DSL ports.

For a more general description of the **"port"** command, see [section 10.3.1](#).

Use **"show port [dsl|shdsl] [<PORT|PORTLIST>]"** port configuration information of the given PORT or PORTLIST. Alternatively, the command **"show"** can be run within the SHDSL Port Configuration context, to show the configuration of a port (or list of ports).

Default values Not applicable.

12.3.2 Setting SHDSL port mode (CO/CPE)

Syntax [no] co

Context SHDSL Port Configuration context

Usage Set the SHDSL port to operate in *central office* (CO) or *customer premises equipment* (CPE) mode.

When connecting switches via SHDSL it is important that one side puts its SHDSL port in CO mode (**"co"**) while the other side puts its SHDSL port in CPE mode (**"no co"**).

Default values Factory default for DDW-225/226 is to have port 1/1 in *CPE* mode (**"no co"**), and port 1/2 in *CO* mode (**"co"**). Factory default for DDW-x42 (and DDW-x42-485) is to have port DSL 1 in *CPE* mode (**"no co"**), and port DSL2 in *CO* mode (**"co"**).

Use **"show co"** to show whether the SHDSL port is configured to operate as *Central Office* or *Customer Premises Equipment*.

12.3.3 Setting SHDSL port rate

Syntax [no] speed <auto|auto-5696k|0-5696k|0-15304k>

Context SHDSL Port Configuration context

Usage Set SHDSL port rate, either by specifying that auto-negotiation should be used, or that a specific fixed rate should be used. Only the **"speed"** setting on the CO has affect on the established connection.

- *Auto-negotiate*: Use **"speed auto"**, **"speed 0"**, or **"no speed"** to let the rate be auto-negotiated between the SHDSL nodes in the extended SHDSL range 32-15288 kbps on Turbo HW; if not Turbo HW the range is 192-5696 kbps.

Use **"speed auto-5696k"** to let the rate be auto-negotiated in the standard SHDSL range 192-5696 kbit/s.

- *Fixed rate*: Use **"speed RATE"**, where RATE is in range **"1k-15304k"** on products *with* Turbo-HW support, and in range **"1k-5096k"** on products *without* Turbo-HW support, to specify a fixed data rate in kbit/s. Alternatively, specify **"speed 1-15304000"** and **"speed 1-5696000"** respectively, to specify a fixed data rate in bit/s.

The following fixed rates are supported on all SHDSL products: 192k, 384k, 512k, 768k, 1024k, 1280k, 2048k, 2304k, 2688k, 3072k, 3456k, 3840k, 4224k, 4608k, 4992k, 5376k, and 5696k.

Products with Turbo-HW support the following additional fixed data rates: 32k, 64k, 128k, 6200k, 6712k, 7224k, 7736k, 8248k, 8760k, 9272k, 9784k, 10296k, 10808k, 11320k, 11832k, 12344k, 13112k, 13880k, 14648k and 15304k.

If other rates are specified, WeOS will round the value upwards to the nearest supported rate.

Use **"show speed"** to show the SHDSL port's rate setting.

Default values **"speed auto"**

12.3.4 Setting SHDSL port noise-margin

Syntax [no] noise-margin <reliable|normal|high-speed [nonstrict]>

Context SHDSL Port Configuration context

Usage Set SHDSL port *noise-margin*. *Note*: The noise-margin setting is only relevant when the data rate is set to *auto-negotiate* (**"rate 0"**), see [section 12.3.3](#).

Available noise-margin modes:

- *Reliable*: Select **"noise-margin reliable"** to let the rate auto-negotiation optimise for reliability (rather than high data rate).
- *High-Speed*: Select **"noise-margin high-speed"** to let the rate auto-negotiation optimise for high data rate (rather than reliability).

- *Normal*: **"noise-margin normal"** is the default setting for the noise-margin, which gives a tradeoff between reliability and high-speed. Alternatively, the command **"no noise-margin"** can be used.

Using the parameter *nonstrict* after the selected noise-margin mode will configure the unit to a less strict algorithm during the connection phase. The resulting current SNR will not necessary match the configured noise-margin mode.

Use **"show noise-margin"** to show the SHDSL port's noise-margin setting.

Default values **"noise-margin normal"**

Error messages None defined yet.

12.3.5 Setting SHDSL port G.HS Threshold

Syntax [no] ghs-threshold <low|medium|high>

Context [SHDSL Port Configuration](#) context

Usage Set SHDSL port to operate with new *G.HS Threshold* value. The G.HS Threshold setting is only needed if the unit are located in a noisy environment with SHDSL line cables of good quality and where a connection can not even be established at SHDSL rate 192kbit/s, see [section 12.1.2](#). The setting configures a higher threshold of the G.HS idle parameter in order to detect idle. The SHDSL line length capability will be affected, since the G.HS idle threshold and the G.HS signals meet earlier when the G.HS Threshold is raised.

When enabling G.HS Threshold, possible settings include **"low"**, **"medium"**, **"high"** and a custom configured value. Corresponding values to the fixed value settings are [low-750; medium-1500; high-3000].

The custom configured value could be set in the range [0-32767] in steps of 1.

Use **"no ghs-threshold"** to disable the G.HS threshold.

Use **"show ghs-threshold"** to show the SHDSL port's G.HS Threshold setting.

Default values Disabled (**"no ghs-threshold"**)

12.3.6 Setting SHDSL PAF mode

Syntax [no] paf

Context SHDSL Port Configuration context

Usage Set the SHDSL unit to operate in *paf* mode.

PAF aggregates the 2 SHDSL ports to achieve higher bandwidth. The functionality demands that the rate do not differ more than 4 times between port 1 and 2 to ensure good performance. Port 2 must be configured to the same role (CO/CPE) as port 1 to get the functionality working.

 **Note**

| This functionality is only available on DDW-x42 and DDW-x42-485.

Use "**show paf**" to show whether PAF is enabled or not.

Default values Disabled

12.3.7 Setting SHDSL low jitter mode

Syntax [no] low-jitter

Context SHDSL Port Configuration context

Usage Set the SHDSL unit to operate in *low jitter* mode.

Low jitter can be enabled to minimize the jitter of the latency over the SHDSL link in applications where high accuracy of the Ethernet packet jitter is needed. This functionality is using a different SHDSL mode compared to default setting, thus the Low Jitter configuration must be set on both SHDSL ports sharing the physical cable.

Use "**show low-jitter**" to show the SHDSL port's low-jitter setting.

Default values Disabled

12.3.8 Setting SHDSL emergency freeze mode

Syntax [no] emf

Context SHDSL Port Configuration context

Usage Set the SHDSL unit to operate in *emf* mode.

EMF enabled makes the unit detect exception situations on the SHDSL links.

The detection will freeze the SHDSL transceiver parameters temporarily to keep the link up. With this function enabled the unit might avoid a complete SHDSL retrain that could take up to a minute. The unit may lose data even with this functionality enabled, but only for a short period of time.

Use "**show emf**" to show the SHDSL port's emergency freeze setting.

Default values Enabled

12.3.9 Show SHDSL port status

Syntax show shdsl

Context Admin Exec context.

Usage Show the status of all SHDSL ports.

Default values Not applicable.

Chapter 13

ADSL/VDSL Port Management

The Falcon-206 is equipped with a xDSL port, i.e., a port capable of operating in either ADSL or VDSL mode. Thus, the Falcon-206 can be used as customer premises equipment (CPE), acting either as switch or router, when connecting to an ISP over an ADSL or VDSL line.

This chapter describes how to setup and manage your xDSL port, as well as the most common configuration steps to connect to your ISP.

13.1 Overview of ADSL/VDSL Port Management

Feature	Web	CLI	General Description
xDSL mode (ADSL/VDSL)	X	X	Section 13.1.1
xDSL carrier (POTS/ISDN)	X	X	Section 13.1.1
External splitter (filter)	X	X	Section 13.1.1
ADSL/ATM specific settings			
ATM VPI/VCI	X	X	Section 13.1.1-13.1.2
ATM Encapsulation	X	X	Section 13.1.1-13.1.2
Restart/retrain xDSL link	X	X	
View xDSL port configuration	X	X	
View xDSL port status/statistics	X	X	
xDSL settings in common with Ethernet ports	X	X	Section 13.1.3
ISP and network settings	X	X	Section 13.1.1, 13.1.4

13.1.1 ADSL/VDSL overview

A Falcon xDSL router is typically used as a *broadband router* (fig. 13.1a, when connecting a private company network to the Internet via xDSL. An alternative is to use Falcon as a *xDSL/Ethernet bridge* (fig. 13.1b), to connect a single PC or an external (non-“xDSL capable”) router to the Internet.

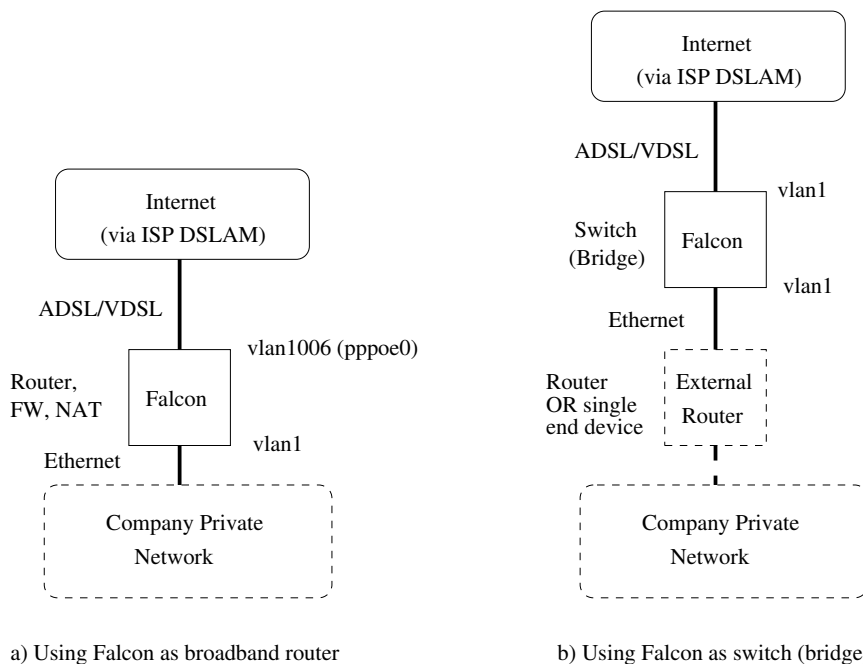

Figure 13.1: Common ADSL/VDSL topologies: a) Using Falcon as broadband router, or b) using Falcon as on xDSL/Ethernet switch (bridge).

When connection your Falcon xDSL unit to your ISP, you may have to configure settings related to the *xDSL port* as well as IP settings specific to your xDSL provider. To configure your Falcon router for the first time, it is recommended to use the Web based *Basic Setup Page*, see [section 13.2.1](#).

More information on xDSL settings is found below and in [sections 13.1.2-13.1.4](#).

- **xDSL settings:**

- *ADSL or VDSL:* As the Falcon can be used both for ADSL and VDSL connections, you may have to configure the xDSL mode.

Default: **ADSL**

- *POTS or ISDN carrier*: Depending on the kind of telecom network used to carry your xDSL connection, you should configure the *Annex* setting accordingly: "**Annex A, I, L, and/or M**" for POTS carrier networks, or "**Annex B or J**" for ISDN carrier networks.

Further details on configuration of the *Annex* setting:

- * **Annex setting for ADSL over POTS**: For ADSL over POTS carrier, "Annex A" is base annex implicitly available. Other annexes for POTS (I, L, M, N) are extensions to Annex A. You can specify to only use Annex A, or you can specify to use additional extensions:
 - "**Annex A**": The WeOS unit announces capability of Annex A (ADSL over POTS). This is the default setting of ADSL.
 - "**Annex I**": The WeOS unit announces capability of Annex A and I. Annex I allows for additional encoding techniques for ADSL over POTS.
 - "**Annex L**": The WeOS unit announces capability of Annex A and L. Annex L allows for additional frequency bands (at lower POTS frequency), and longer reach.
 - "**Annex M**": The WeOS unit announces capability of Annex A and M. Annex M allows for additional frequency bands (at higher POTS frequency).
 - "**Annex L-M**": The WeOS unit announces capability of Annex A, L and M.
- * **Annex setting for ADSL over ISDN**: For ADSL over ISDN carrier, "Annex B" is base annex implicitly available. Annex J is an extension to Annex B for ADSL over ISDN. You have the following configuration options:
 - "**Annex B**": The WeOS unit announces capability of Annex B (ADSL over ISDN).
 - "**Annex J**": The WeOS unit announces capability of Annex B and J. Annex J allows for additional encoding techniques for ADSL over ISDN.
- * **Annex setting for VDSL**: For VDSL it is possible to let the WeOS unit automatically probe what carrier network is used (by choosing "**Annex A-B**"); if this does not work to bring up the VDSL line, one

can manually try the individual settings "**Annex A**" and "**Annex B**" respectively.

Default: **ADSL Annex A** (ADSL over POTS)

- *Use of external Filter (Splitter) or not:* If you wish to use your xDSL connection for regular phone calls, the Falcon xDSL port should (1) be connected to a splitter which in turn connects to the (first) telephone jack, and (2) the Falcon xDSL "**filter**" setting should be *enabled*.

Otherwise, the Falcon xDSL port should (1) be connected directly to the (first) telephone jack, and (2) the Falcon xDSL "**filter**" setting should be *disabled*.

Default: **Filter enabled** (i.e., it is assumed the Falcon xDSL port is connected via a *splitter*)

- **ADSL specific settings:** When using Falcon for ADSL (as opposed to VDSL), a few settings related to ADSL/ATM encapsulation and VPI/VCI may have to be set, see [section 13.1.2](#) below.
- **Use of PPPoE, DHCP or Static IP address assignment:** xDSL providers use different schemes to assign IP addresses to their customers. These methods to assign an IP address are not specific to xDSL connections, thus are explained in detail in other chapters: [chapter 35](#) describes use of PPPoE, and [chapter 22](#) covers use of DHCP as well as static IP address assignment.

To simplify configuring IP settings appropriate for your xDSL subscription, the Falcon Web interface has a *Basic Setup Page*, see [section 13.2.1](#).

For those who wish to configure Falcon via the CLI, [section 13.1.4](#) below provides useful information.

Default: **DHCP** (i.e., acquire your IP address from your ISP via DHCP)

- **VLAN settings:** By factory default, the xDSL port will belong to VLAN 1006 (untagged), while all Ethernet ports will be belong to VLAN 1 (untagged).

If the Falcon is configured to act as *xDSL/Ethernet Bridge* via the *Basic Setup Page* (see [section 13.2.1](#)), all ports (xDSL and Ethernet) will be mapped to VLAN 1.

13.1.2 ADSL specific settings

There are two types of ADSL specific xDSL settings, and both of them concern the use of ATM as ADSL carrier.

- *VPI and VCI*: In WeOS you need to define the identifier of your ATM permanent virtual circuit (PVC) to your ADSL provider. This identifier contains two parts, the virtual path identifier (VPI) and the virtual circuit identifier (VCI). What values to use depends on your ISP provider.

Default: **VPI 8** and **VCI 35**

- *ATM Encapsulation*: Falcon units support two ATM encapsulation modes: "bridged LLC" and "bridged VC-MUX" ([11]). Which setting to use depends on your ISP provider.

Default: **bridged LLC**

There is also an additional ADSL related setting to specify if the ADSL is carried over a POTS telecom network (Annex A, I, L, or M), or an ISDN telecom network (Annex B or J). However, as of WeOS v4.33.0 the "**annex**" setting also applies to VDSL, see [section 13.1.1](#).

Default: **Annex A (POTS)**

13.1.3 xDSL settings in common with Ethernet ports

The following parameters can be configured for xDSL ports in the same way as for Ethernet ports. In WeOS, VDSL uses Ethernet First Mile (EFM) encapsulation, and ADSL uses "bridged" LLC or VC-MUX encapsulation (see [section 13.1.2](#)), thus many Ethernet settings apply to xDSL ports. More detailed information is found in [chapter 10](#).

- *Port enable/disable*: Ports can be disabled and enabled administratively.
- *Port priority mode*: Define whether incoming packets should be prioritised based on VLAN tag, VLAN ID, port ID, IP ToS, etc. See also [section 10.1.4](#).
- *Port priority (level)*: The inbound priority associated with this port. See also [section 10.1.4](#).
- *Link alarm*: Link status can be configured as an alarm source. See also [section 10.1.5](#).
- *Inbound rate limit*: Setting the inbound rate limit is possible on DSL ports, but is likely of less interest than on Ethernet ports, since the DSL data rates are primarily limited by the rate of the DSL line. See also [sections 10.1.7](#) and [13.1.1](#).
- *Outbound traffic shaping*: Setting the outbound rate limit (traffic shaping) is possible on DSL ports, but is likely of less interest than on Ethernet ports,

since the DSL data rates are primarily limited by the rate of the DSL line. Furthermore, outbound traffic shaping in *frames per second* mode is not available on DSL ports. See also [sections 10.1.8](#) and [13.1.1](#).

- *Bandwidth Statistics*: Enable or disable bandwidth statistics per port. See also [section 10.1.9](#).
- *Fall-back default-VID*: The fall-back default VID setting is only of interest for the special case when *untagged* packets are received over a link only associated with *tagged* VLANs.

Ethernet settings for *port speed/duplex* mode, and *MDI/MDIX* mode do not apply to xDSL ports, thus are not configurable.



Note

As of WeOS v4.33.0, enabling/disabling flow control (as described in [section 10.1.3](#)) has no effect on xDSL ports.

13.1.4 Connecting to your ISP over an xDSL line



Recommendation: Use Basic Setup in Web

The simplest way to configure your Falcon unit to connect to your ISP is to use the *Basic Setup* web page, see [section 13.2.1](#).

This section is intended (1) for those who wish to configure the Falcon via the CLI, and (2) for those looking for more background details on how to configure Falcon as an xDSL router or bridge.

This section describes the most common steps to configure your Falcon xDSL router to connect to your ISP. Although many configuration settings are affected, setting up your ISP should be straight-forward:

- The factory default configuration of xDSL are adapted to using the Falcon as an xDSL router.
- On the Falcon xDSL router, the web interface includes a *basic setup* page, for easy configuration of the most common use cases, see [section 13.2.1](#).

A common setup is use Falcon as broadband router when connecting your company network towards the Internet, see [fig. 13.2a](#).

An alternative is to use the Falcon as a xDSL/Ethernet bridge to connect a single end device (such as a PC), or to use a separate router to connect your local network, as shown in [fig. 13.2b](#).

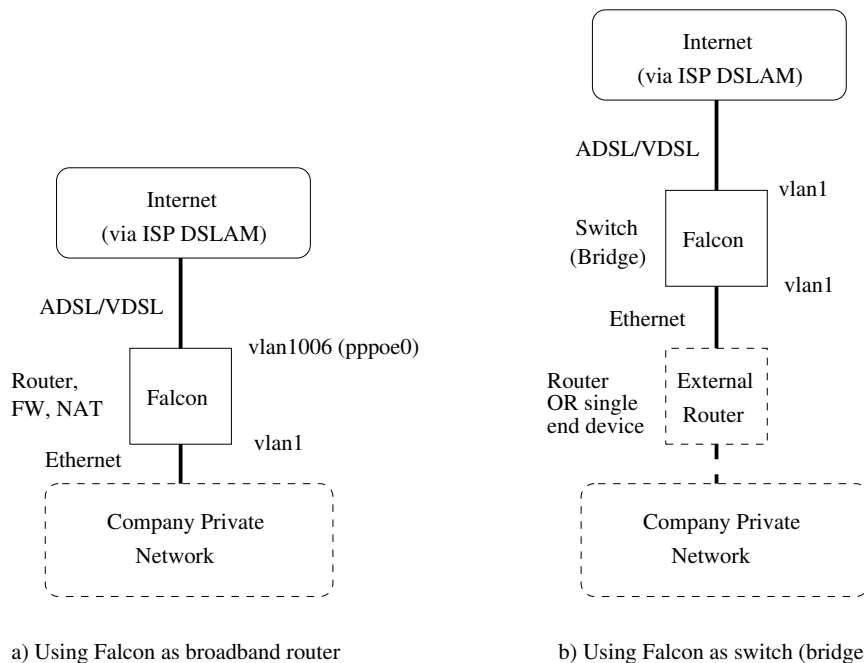

Figure 13.2: Common ADSL/VDSL topologies: a) Using Falcon as broadband router, or b) using Falcon as an xDSL/Ethernet switch (bridge) with an external router (or single end-device such as a PC) behind.

[Section 13.1.4.1](#) focus on using Falcon as a router, while [section 13.1.4.1](#) covers on how to use Falcon as a switch (bridge). Both sections assume you have configured the xDSL port settings appropriately for your xDSL subscription (see also [sections 13.1.1](#) and [13.1.2](#)).

13.1.4.1 Using Falcon as a Router

By factory default, Falcon is configured as a router:

- **Port Segmentation:** The xDSL and Ethernet ports are mapped to two VLANs.
 - *WAN port:* The xDSL port is mapped to VLAN 1006. VLAN 1006 had IGMP snooping disabled, thereby avoiding sending IGMP queries towards your ISP.

Example

```
vlan 1006
    untagged dsl 1
    no igmp
    ...
```

- *LAN ports*: The Ethernet ports are used as LAN ports, and are all mapped to the default VLAN, i.e., VLAN 1. VLAN 1 has the same factory default settings as other WeOS products.

Example

```
vlan 1
    untagged eth 1-4
    igmp
    ...
```

- **Network Interface Settings:**

- *WAN interface*: There are three methods to assign the IP address of the WAN interface, and which method to use depends on your xDSL Internet Service Provider (ISP): (1) acquire it via *DHCP*, (2) configure a *static* IP address, or (3) acquire the IP address via *PPPoE*. Each method is described below.

By default, Falcon is configured to acquire the WAN interface address via DHCP.

1. *Address via DHCP*: The WAN interface will by default use DHCP to get its IP address automatically from the ISP. In addition, interface *vlan1006* is assigned *admin distance "1"* ([section 22.2.6](#)), in order to dynamically learn default gateway, DNS server and other global information via DHCP. Management services such as SSH, HTTP (Web), etc. are by default disabled to avoid unauthorised access from the public Internet.

Example

```
iface vlan1006 inet dhcp
    distance 1
    no management
end
```

2. *Static IP address*: The WAN interface can be configured to get its IP address assigned statically. If your ISP provides this option, the ISP will inform you what address to use for your subscription. The example below uses address *192.168.5.4* and netmask *255.255.255.192* to illustrate the method.

 **Example**

```
iface vlan1006 inet static
    distance 1
    no management
    address 192.168.5.4/26
end
```

With static IP assignment you would also need to set the IP address of the default gateway and DNS server(s) (information provided by your ISP). In the example below the default gateway has address *192.168.5.1*, and a DNS server at *192.168.5.2*.

 **Example**

```
ip
    route default 192.168.5.1
    name-server 192.168.5.2
    ...
end
```

3. *Address via PPPoE*: Some ISPs use *PPPoE* for authorisation of, and IP address assignment to, their customers. To configure a WAN interface to use *PPPoE*, a *PPPoE* instance is created and mapped to the associated VLAN interface (here *vlan1006*). This will in turn create a *PPPoE* interface (here *pppoe0*), which now acts as our WAN interface. The example below shows the default setting for the *PPPoE* interface; the *admin distance* and *management* settings are automatically *copied* from the configuration of interface *vlan1006*.

 **Example**

```
pppoe 0
    iface vlan1006
    ppp-advanced
        identity username@provider password sEcReT
    end
end
...
iface pppoe0 inet dynamic
```

```
mtu 1492
tcp-mss 1412
distance 1
no management
end
```

As interface *pppoe0* is typically used as upstreams interface, the NAT settings should be adapted, see *Routing, Firewall and NAT* below.

- **LAN interface:** The LAN interface *vlan1* is by default assigned IP address *192.168.2.200*. All management services are enabled on the LAN interface.

Example

```
iface vlan1 inet static
distance 16
management ssh http https ipconfig snmp
address 192.168.2.200/24
end
```

- **Routing, Firewall and NAT:** Falcon by default has IP forwarding (routing) and NAT enabled. Thereby Falcon can route packets between a private network on its LAN interface (*vlan1*) and the public Internet on its WAN interface.

The default firewall and NAT rules will block all incoming traffic on the WAN interface, except for packets belonging to established connections. (Such connections are in turn initiated from the private network, i.e., from the LAN side.) These settings are chosen to limit the risk for security attacks when connecting the Falcon to a public network such as the Internet.

Special firewall deny rules are set up for TCP and UDP port 53 (DNS). These are to prevent the Falcon to become an open DNS relay on the WAN side.

Open DNS relay is considered to be a security problem and can be used for remote attacks of the ISP's DNS server. DNS relay is enabled on all interfaces and should be filtered away on all interfaces facing public networks. Normal DNS traffic originating from the inside (from the LAN) will work as expected and is not affected by these rules.

Example

```
ip
    forwarding
    firewall
```

```

policy input DROP
policy forward DROP
filter allow in vlan1 proto icmp
filter deny in vlan1006 dport 53 proto udp
filter deny in vlan1006 dport 53 proto tcp
nat type napt out vlan1006 addfilter
enable
end

```

Adapting Firewall and NAT rules when using PPPoE

When PPPoE is used for WAN IP address assignment (see above), the firewall and NAT rules must be adapted accordingly, i.e., "vlan1006" should be replaced by "pppoe0" as shown in the example below.

Example

```

ip
  forwarding
  firewall
    policy input DROP
    policy forward DROP
    filter allow in vlan1 proto icmp
    filter deny in pppoe0 dport 53 proto udp
    filter deny in pppoe0 dport 53 proto tcp
    nat type napt out pppoe0 addfilter
  enable
end

```

- **Other Configurations:** The items above cover the most important configuration settings when connecting a Falcon to your ISP. Notes on a few more settings are given below:
 - *RSTP:* Westermo switches running WeOS typically have RSTP enabled on all Ethernet and DSL ports. However, the xDSL port on Falcon have RSTP disabled by default. For more information on RSTP, see [chapter 18](#).
 - *VPN:* Its possible to use the Falcon as a VPN gateway. For more information on configuring VPNs in WeOS, see [part IV](#).
 - *DHCP Server:* For information on how to make your Falcon act as DHCP server on your local network (*vlan1*), see [chapter 23](#).

13.1.4.2 Using Falcon as a Switch (Bridge)

As shown in [fig. 13.2b](#), it is possible to use the Falcon as a xDSL/Ethernet bridge. That is, the xDSL port does not have to be used as a dedicated *router* port;

instead the Falcon could *switch* packets between Ethernet and xDSL ports, given that they are mapped to the same VLAN (see [chapter 15](#)).

Although it is possible to make the Falcon work as a *regular* WeOS switch, there are some differences:

- *Falcon is a router by default*: All WeOS devices can be configured to act as *router* or *switch*. The difference is that Falcon is configured as router in its factory default setting (able to route between the WAN interface *vlan1006* and the LAN interface *vlan1*, while other WeOS devices act as switches by default (all ports on VLAN 1).
- *Layer-2 Redundancy (RSTP/FRNT)*: As the xDSL port is used to connect to a xDSL provider (ISP), the remote end is managed by an external organisation. Thus, layer-2 redundancy protocols such as RSTP and FRNT should not be used on the xDSL port; for FRNT this is prohibited, and for RSTP it is disabled by default.

The simplest way to configure your Falcon to act as a switch is by using the *Basic Setup Page* in the Web interface ([section 13.2.1](#)). This way, all ports (Ethernet and xDSL) will be mapped to VLAN 1. The Falcon will then be accessible via the default IP address (IP address 192.168.2.200, netmask 255.255.255.0) unless you have changed the IP settings of interface *vlan1*. As an alternative to using the *Basic Setup Page*, you could achieve the corresponding result by removing VLAN 1006, either via the Web interface ([section 15.3](#)) or via the CLI ([section 15.4](#)) as shown below.

 **Example**

```
falcon:/#> show vlan
```

VID	Name	Oper	Untagged/Tagged
1	vlan1	DOWN	U:eth 1-4 T:
1006	vlan1006	DOWN	U:dsl 1 T:

```
falcon:/#>
```

Example

```
falcon:/#> configure
falcon:/config/#> no vlan 1006
falcon:/config/#> end
Port dsl 1 did not belong to any VLAN, setting as untagged in VLAN 1.
vlans: Problem activating settings.
There was some problem activating your configuration changes!

This could result in a non-functional system, continue anyway (y/N)? y
OK, accepting configuration anyway -- please review the running configuration.
Stopping DHCP Clients ..... [ OK ]
Configuration activated. Remember "copy run start" to save to flash (NVRAM).
falcon:/#> show vlan
Press Ctrl-C or Q(uit) to quit viewer, Space for next page, <CR> for next line.

VID  Name                Oper  Untagged/Tagged
-----
  1  vlan1                 UP    U:ALL
                                   T:
-----

falcon:/#> cp running-config startup-config
falcon:/#>
```

There are additional settings you may consider changing when running the Falcon as a switch:

- *Limit remote management:* When the xDSL port is mapped to VLAN 1, the Falcon will be open for remote management via the xDSL port just as it is via the Ethernet ports on VLAN 1.

This is usually no problem, as the Falcon by default is assigned the default IP address (192.168.2.200) on interface *vlan1*, and that address is not routable via the ISP. However, if limiting remote management is still a concern, you could, e.g., remove the IP address of interface *vlan1*. The Falcon can then be managed only via the console port (CLI) instead.

Example

```
falcon:/#> configure
falcon:/config/#> iface vlan1
falcon:/config/iface-vlan1/#> inet static
falcon:/config/iface-vlan1/#> show address
192.168.2.200/24
falcon:/config/iface-vlan1/#> no address
falcon:/config/iface-vlan1/#> leave
Configuration activated. Remember "copy run start" to save to flash (NVRAM).
falcon:/#>
```

- *As switch there is no firewall:* Acting as a switch, the Falcon no longer serves as a firewall towards the Internet. You should therefore ensure that you protect your local network, typically by running firewall in an external router (or in a directly attached PC), see [fig. 13.2b](#).
- *Disable IGMP Snooping:* VLAN 1 has IGMP snooping enabled by default. This should be fine even when the xDSL port is on VLAN 1, however, if you have concerns about running IGMP snooping on a port towards your ISP you can disable IGMP snooping on VLAN 1.

Example

```
falcon:/#> configure
falcon:/config/#> vlan 1
falcon:/config/vlan-1/#> no igmp
falcon:/config/vlan-1/#> leave
Stopping IGMP Snooping daemon ..... [ OK ]
Configuration activated. Remember "copy run start" to save to flash (NVRAM).
falcon:/#>
```

- *Disable IP Forwarding:* As long as all ports are mapped to VLAN 1, the Falcon will act as a switch, even though the *IP forwarding* configuration option is enabled. However, if you have concerns about having IP forwarding enabled, you can disable it.

If you use the *Basic Setup Page* in the Web interface ([section 13.2.1](#)) to configure the Falcon as switch (bridge), IP forwarding will be disabled automatically.

Example

```
falcon:/#> configure
falcon:/config/#> ip
falcon:/config/ip/#> no forwarding
falcon:/config/ip/#> leave
Configuration activated. Remember "copy run start" to save to flash (NVRAM).
falcon:/#>
```

13.2 Managing ADSL/VDSL ports via the web interface

The Web interface provides configuration of xDSL ports (sections 13.2.1-13.2.3) as well as listing of xDSL port statistics.

The xDSL statistics is provided in two views – an *overview* with a selection of statistics for all xDSL ports, including some status information (section 13.2.4), and a *detailed* page with a larger set of statistics (section 13.2.5).

13.2.1 Basic Setup for Falcon DSL router

Menu path: Basic Setup

This feature requires a JavaScript enabled web browser. To simplify the setup of the Falcon unit for remote access, a basic setup page is provided with the most basic settings compiled into one view. In many cases this page may be sufficient for setting up the Falcon for remote access.

Note
When you enter the basic setup page and make changes to the configuration and press the apply button, some settings will be reset. See section 13.2.1.1 below for more information.

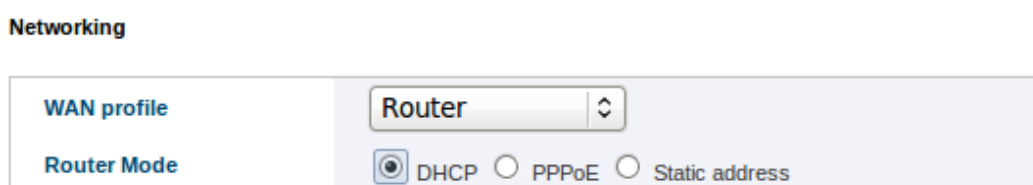

Figure 13.3: Basic Setup Profile and Mode

To set up the switch using the Basic Setup, two fundamental settings have to be set first. These two settings control the other options displayed on the page.

WAN Profile	Router	The unit will be set up as a router with a firewall protecting the LAN side from the WAN side.
	Bridged	The unit will act as a plain switch.
Continued on next page		

Continued from previous page		
Router Mode	DHCP	The WAN side will expect a DHCP-server to provide the switch with an IP address.
	PPPoE	The WAN side will set up a PPPoE connection with the ISP to provide the internet connection.
	Static	The IP address, netmask and gateway will be manually entered.

The *DHCP* router mode (shown above) does not need any additional settings. The *Static IP* and *PPPoE* router modes require additional settings as described below.

Irrespective of the selected *router mode*, you may also need to fill out ADSL/VDSL port settings, as shown at the end of this section.

Static IP Settings

Networking

Figure 13.4: Basic Setup Static IP

If the static IP mode is selected you are asked to fill in the following entries.

Address	The IPv4 address to assign to the interface.
Netmask	The netmask for the IPv4 address. Identifies which IP addresses are located on the same subnet.
Continued on next page	

Continued from previous page	
Default Gateway	Statically configured default gateway of the unit. This is the IP address of the gateway to send packages to when no more specific route can be found in the routing table. This value overrides any value retrieved dynamically (e.g. using DHCP). Leave empty to enable dynamically retrieved gateway address or if no default gateway should be available.

PPPoE Settings

Networking

The screenshot displays the configuration page for PPPoE. On the left sidebar, the following options are visible: WAN profile, Router Mode, PPPoE Settings, Username, and Password. The main configuration area includes a dropdown menu set to 'Router', three radio button options: 'DHCP', 'PPPoE' (which is selected), and 'Static address'. Below these is a note: 'For advanced setup enter [configuration](#) context.' There are two input fields: the first contains the text 'test' and is labeled 'Username' in the sidebar; the second is a password field with masked characters and is labeled 'Password' in the sidebar.

Figure 13.5: Basic Setup PPPoE

If the PPPoE mode is selected you are asked to fill in the following entries.

Username	The username provided by the PPPoE provider.
Password	The password provided by the PPPoE provider.

DSL Settings

DSL Port Settings

Mode	ADSL
ADSL	
ATM Encapsulation	LLC Bridged
ATM PVC Framing	
VPI	8
VCI	35
Annex A=POTS B=ISDN	<input checked="" type="radio"/> A <input type="radio"/> B
Filter (External Splitter)	<input checked="" type="radio"/> Yes <input type="radio"/> No

Figure 13.6: Basic Setup DSL settings

In addition you may have to change the DSL settings if they do not satisfy the requirements from your ISP, see [fig. 13.6](#).

Mode	Specify whether the xDSL port should operate ADSL port or VDSL port. Default: ADSL
ATM Encapsulation	ATM encapsulation. Default: LLC
ATM PVC Framing	Set the appropriate VPI and VCI for the ATM PVC. Default: VPI 8, VCI 35
Annex	Annex A or B can be set for either ADSL or VDSL mode. Annex L, M, L-M, I and J can only be set for ADSL. The annex I and J options are extensions of ADSL annex A and B. The annex L and M options are extensions of ADSL annex A. The annex A-B option is only available for VDSL mode. Default: Annex A (POTS)
Filter	External splitter or not. POTS/ISDN filter. Default: Enabled

13.2.1.1 Basic Setup Behavior

As noted above, some settings will be reset when applying the basic setup page. This is what will happen:

- **When applying bridged profile:**

All but one VLAN is removed and its interface settings are reset.

Details:

- All VLANS are removed and VLAN 1 re-created. As a result of this, all advanced settings on VLAN 1 and it's associated interface will be lost.
- All ports are associated untagged to VLAN 1.
- The firewall is removed.
- IP-forwarding (routing) is turned off.

- **When applying a router profile:**

All settings for LAN and WAN and its associated interfaces are reset. Firewall rules are reset. All existing PPPoE configurations are removed.

Details:

- All VLANS are removed and VLAN 1 (LAN) and VLAN 1006 (WAN) re-created. As a result of this, all advanced settings on VLAN 1 and VLAN 1006 and their associated interfaces will be lost.
- The DSL port is associated untagged to VLAN 1006 (WAN).
- All remaining ports are associated untagged to VLAN 1 (LAN).
- The firewall is removed and then re-created. This will result in loss of all current NAT, Port forwarding and Access rules.
- IP-forwarding (routing) is turned on.

In addition for the DHCP and Static modes:

- A NAT-rule for external interface VLAN 1006 (WAN) and internal VLAN 1 (LAN) is added.
- Firewall filtering rules denying inbound UDP and TCP port 53 (DNS) are added for the external interface VLAN 1006 (WAN).

In addition for the PPPoE mode:

- A PPPoE configuration is added.

- A NAT-rule for the PPPoE interface (WAN) and internal VLAN 1 (LAN) is added.
- Firewall filtering rules denying inbound UDP and TCP port 53 (DNS) are added for the PPPoE interface (WAN).

**Note**

Firewall filtering of inbound UDP and TCP port 53 is added to prevent the unit to become an open DNS relay on the WAN side.

Open DNS relay is considered to be a security problem and can be used for remote attacks of the ISP's DNS server. DNS relay is enabled on all interfaces and should be filtered away on all interfaces facing public networks. Normal DNS traffic originating from the inside (from the LAN) will work as expected and is not affected by these rules.

13.2.2 List and Edit ADSL/VDSL Port Settings



Menu path: Configuration ⇒ Port ⇒ DSL

When entering the DSL configuration page you will be presented to a list of all DSL ports available on your switch, see [fig. 13.7](#).

DSL Configuration

	Port	Enabled	Mode	Link Alarm Enabled		
	1		adsl			

Figure 13.7: DSL Port configuration settings overview

 Alarm	There is an active link alarm associated with the port. Only shown if link alarm is enabled and the link is down.
Port	The port label.
Enabled	A green check-mark means the xDSL port is enabled, and a dash means it is disabled.
Type	ADSL or VDSL
Link Alarm Enabled	When link alarm is enabled an alarm will be generated if port link is down. Alarms trigger an SNMP trap message to be sent and alarms to be shown on the administration web. In the ports overview table a green check-mark means enabled, and a dash means disabled.
 Edit	Click this icon to edit a port's settings.
 Restart	Click this icon to retrain the DSL ports.

To change the settings for a specific xDSL port you will have to click the edit icon which will take you to the DSL port setting edit page see [section 13.2.3](#).

13.2.3 Edit xDSL Port Settings

Menu path: Configuration ⇒ Port ⇒ DSL ⇒ 

DSL-port 1

Enabled	<input type="checkbox"/>
Mode	ADSL
ADSL	
ATM Encapsulation	LLC Bridged
ATM PVC Framing	
VPI	8
VCI	35
Annex A=POTS B=ISDN I=POTS J=ISDN L=POTS M=POTS	<input checked="" type="radio"/> A <input type="radio"/> B <input type="radio"/> I <input type="radio"/> J <input type="radio"/> L <input type="radio"/> M <input type="radio"/> L-M
Filter (External Splitter)	<input checked="" type="radio"/> Yes <input type="radio"/> No
Priority Mode	VLAN Tag
Port Priority	0
Inbound Rate Limit	Disabled
Outbound Traffic Shape	Disabled
Link Alarm	<input type="checkbox"/>
Bandwidth Statistics	<input type="checkbox"/>

Apply Cancel

Figure 13.8: DSL port configuration settings edit page

On this page you can change the settings for the xDSL port.

Enabled	Enable or Disable the port
Mode	Specify whether the xDSL port should operate ADSL port or VDSL port. Default: ADSL
ATM Encapsulation	ATM encapsulation. Default: LLC
ATM PVC Framing	Set the appropriate VPI and VCI for the ATM PVC. Default: VPI 8, VCI 35
Continued on next page	

Continued from previous page	
Annex	Annex A or B can be set for either ADSL or VDSL mode. Annex L, M, L-M, I and J can only be set for ADSL. The annex I and J options are extensions of ADSL annex A and B. The annex L and M options are extensions of ADSL annex A. The annex A-B option is only available for VDSL mode. Default: Annex A (POTS)
Filter	External splitter or not. POTS/ISDN filter. Default: Enabled
Priority Mode	Here you select on what information priority will be based: Port Based Based on the port's priority. See the next item (Priority). IP Based on the content of the IP ToS bits (IPv4) or the IP TC bits (IPv6). VLAN Tag Based on the content of the (802.1p) priority field inside the received packet's VLAN tag.
Port Priority	The port's priority level.
Inbound Rate Limit	Bandwidth limit for inbound traffic
Outbound Traffic Shape	Bandwidth limit for outbound traffic
Link Alarm	When link alarm is enabled an alarm will be generated if port link is down. Alarms trigger an SNMP trap message to be sent and alarms to be shown on the administration web.
Bandwidth Statistics	Enable or disable bandwidth monitoring per port. See Section 11.2.2 for how to view the statistics that is gathered when this function is enabled.

13.2.4 ADSL/VDSL statistics Overview

Menu path: Status ⇒ Port ⇒ DSL



On the DSL port statistics overview page you will be presented to a selection of static data for each port. Additional statistic numbers are presented on the detailed view page.

Note: If only one DSL port is present in the unit, you will be redirected to the detailed statistics and status page.

DSL Statistics

Port	Negotiation State	State	Downstream rate (KBits/s)	Upstream rate (KBits/s)	Total Bytes In	Total Bytes Out	Details
1	No sync state	DISABLED	0	0	0	0	

Auto refresh: Off, [5s](#), [15s](#), [30s](#), [60s](#)

 Alarm	An alarm icon appears at the start of a line if there is a link alarm on a port.
Port	The port label.
Negotiation State	Current state of the DSL-line negotiation.
State	Link state
Downstream Rate	Negotiated DSL downstream rate in bit/s.
Upstream Rate	Negotiated DSL upstream rate in bit/s.
Total Bytes In	Total number of bytes received on the port.
Total Bytes Out	Total number of bytes sent out on the port.
 Details	Click this icon to view more detailed statistics for the port.
Auto Refresh	Click on a value to make the page reload with updated statistics automatically every 5, 15, 30 or 60 seconds. Click Off to turn off auto refresh.
Refresh	Click on this button to reload with updated statistics.

13.2.5 Detailed ADSL/VDSL Port Statistics

Menu path: Status ⇒ Port ⇒ DSL ⇒ 

If only one DSL port is present in the unit, or when clicking the *details*-icon in the overview page you will be presented to the detailed statistics page for the DSL port.

DSL Status and Statistics - Port 1

Link Status	Up
Link Uptime	0 Days 0 Hours 11 Mins 55 Secs
DSL mode	ADSL/Anx-A
Negotiation State	Sync state
Negotiations	2
Remote vendor name	GSPN

	Downstream	Upstream
- Rate (KBits/s)	8000	832
- SNR (dB)	8.6	12.0
- Line attn (dB)	20.2	12.5
- Signal attn (dB)	20.1	12.5
- Output power (dBm)	13.9	12.4

Traffic Counters	Inbound	Outbound
Total Bytes	0	18683
Broadcast Packets	0	73
Multicast Packets	0	171
Unicast Packets	0	0
Dropped Packets		

Traffic Size, Inbound	Packets
Octets	
64	0
65 -> 127	0
128 -> 255	0
256 -> 511	0
512 -> 1023	0
1024 -> Max	0

Auto refresh: Off, [5s](#), [15s](#), [30s](#), [60s](#)

Link Status	Status of link, (Up/Down). If a link-alarm is associated with this port, an alarm icon is displayed if the link-alarm is active.
Link Uptime	The time since link was established.
DSL mode	ADSL or VDSL
Negotiation State	Current state of the DSL-line negotiation.
Negotiations	Number of negotiations since unit startup.
Remote Vendor Name	Identifier string of DSLAM vendor.
Rate	Negotiated DSL downstream and upstream rate in bit/s.
SNR (dB)	Upstream and Downstream Signal to Noise Ratio (SNR) in dB on this link.
Line attn (dB)	Line attenuation is the loss of signal over distance, in dB, downstream and upstream.
Signal attn (dB)	Signal attenuation in dB, downstream and upstream.
Output power (dBm)	Output power in dBm, downstream and upstream.
Traffic Counters	See section 11.2.2 for details.
Traffic Size, Inbound	See section 11.2.2 for details.
Auto Refresh	Click on a value to make the page reload with updated statistics automatically every 5, 15, 30 or 60 seconds. Click Off to turn off auto refresh.
<<Previous	Go to statistics for previous port. Only shown if more than one DSL port available.
Next>>	Go to statistics for next port. Only shown if more than one DSL port available.
Refresh	Click on this button to reload with updated statistics.
Clear Port	Clear all statistics counters for the port shown.

13.3 Managing ADSL/VDSL ports via the CLI

The table below shows xDSL port management features available via the CLI.

Command	Default	Section
<u>Configure ADSL and VDSL port settings</u>		
port [dsl xdsl . . .] <PORTLIST>		Section 13.3.1
[no] mode <adsl [annex <a b i j m l-m>] vdsl [annex <a b a-b>]>	adsl annex a	Section 13.3.2
[no] filter	Enabled	Section 13.3.3
<u>ADSL specific port settings</u>		
mode adsl		
[no] encap <llc vcmux>	llc	Section 13.3.4
[no] pvc <VPI/VCI>	8/35	Section 13.3.5
<u>Port settings in common with Ethernet ports (chapter 10)</u>		
[no] enable	Enabled	Section 10.3.3
[no] priority <0-7>	0	Section 10.3.7
[no] priority-mode <tag ip port>	tag	Section 10.3.8
[no] link-alarm	Disabled	Section 10.3.9
[no] rate-limit <70-2560>	Disabled	Section 10.3.10
[no] traffic-shaping <70-2560>	Disabled	Section 10.3.11
[no] bandwidth-statistics	Disabled	Section 10.3.12
[no] default-vid <VLAN_ID>	Disabled	Section 10.3.16
<u>Show ADSL/VDSL related status and statistics</u>		
show dsl		Section 13.3.6
show ports		Section 10.3.18
show rmon		Section 11.3

13.3.1 Managing xDSL port settings

Syntax port [dsl|xdsl|. . .] <PORTLIST>

Context [Global Configuration](#) context

Usage Enter the xDSL Port Configuration context.

A **"PORTLIST"** is a comma separated list of ranges of xDSL ports without intermediate spaces, e.g., **"1/1,1/2"** on a *slotted* product, or **"1-3,5"** on a *non-slotted* product.

The port qualifier keyword **"xdsl"** (or **"dsl"**) is not needed if the numbers in the **"PORTLIST"** are unique to DSL ports.

For a more general description of the **"port"** command, see [section 10.3.1](#).

Use **"show port dsl <PORT|PORTLIST>"** or **"show port xsdl <PORT|PORTLIST>"** to list port configuration information for the given xDSL port(s). Also available as **"show"** command within the xDSL Port Configuration context.

Default values Not applicable.

Entering the xDSL configuration context on a Falcon:

Example

```
falcon:/#> configure
falcon:/config/#> port dsl 1
falcon:/config/port-dsl1/#>
```

Listing configuration information on the xDSL port on a Falcon:

Example

```
falcon:/config/#> show port dsl 1
xDSL ----- Priority ---- Limit - Default
Port  Ena Mode Filter Encap PVC  Annex Alarm Mode Level  In | Out  Vid
-----
DSL 1  YES adsl  YES  llc 8/35  A   NO  tag    0  None None  Auto
-----
falcon:/config/#>
```

13.3.2 Setting xDSL port mode (ADSL or VDSL) and carrier type

Syntax [no] mode <adsl [annex <a|b|i|j|l|m|l-m> |
vdsl [annex <a|b|a-b>>

Context [xDSL Port Configuration](#) context

Usage Specify whether the xDSL port should operate as ADSL port or VDSL port, and

- **ADSL:**
 - Use **"mode adsl annex <a|i|l|m|l-m>"** to specify ADSL mode over a POTS carrier network.
 - Use **"mode adsl annex <b|j>"** to specify ADSL mode over an ISDN carrier network.
 - For further information on ADSL Annex settings, see [section 13.1.1](#).

When selecting ADSL mode, the ADSL specific settings **"encap"** ([section 13.3.4](#)) and **"pvc"** ([section 13.3.5](#)) are enabled.

- **VDSL:**
 - Use **"mode vdsl annex a"** to specify VDSL mode over a POTS carrier network.
 - Use **"mode vdsl annex b"** to specify VDSL mode over an ISDN carrier network.
 - Use **"mode vdsl annex a-b"** to auto-detect whether your VDSL connection is over a POTS or ISDN carrier. This alternative is usually preferable for VDSL connections due to its simplicity, but the auto-detection mechanism may experience problems on long copper cables. If this is the case, please try **"mode vdsl annex a"** or **"mode vdsl annex b"** depending on the carrier type of your VDSL connection.

Use **"no mode"** to reset the mode setting to the default value.

Use **"show mode"** to show whether the xDSL port is set to operate as ADSL or VDSL port, and the type of carrier network used, Annex A, Annex I, Annex L or Annex M (POTS) or Annex B or Annex J (ISDN). Annex I and J not supported in VDSL mode.

Default values ADSL over POTS (**"mode adsl annex a"**)

13.3.3 Specify whether external splitter is used or not

Syntax [no] filter

Context [xDSL Port Configuration](#) context

Usage Specify whether a (external) splitter is used or not, i.e., is the Falcon unit connected directly to the telephone jack or via a splitter.

Use command **"filter"** if a splitter is used, and **"no filter"** if no splitter is used.

Use **"show filter"** to show the xDSL port's filter setting.

Default values "filter" (i.e., an external splitter is assumed by default)

13.3.4 Configure ADSL/ATM encapsulation type

Syntax [no] encap <llc|vcmux>

Context [xDSL Port Configuration](#) context (only available when ADSL mode is used, see [section 13.3.2](#))

Usage Specify whether *bridged LLC* or *bridged VC-MUX* ATM encapsulation is used. What encapsulation option to use depends on your ADSL provider.

Use command **"llc"** to use *bridged LLC* and **"vcmux"** to use *bridged VC-MUX* encapsulation.

Use **"no encap"** to reset the encapsulation mode to the default setting.

Use **"show encap"** to show the xDSL port's ADSL/ATM encapsulation setting.

Default values "llc"

13.3.5 Configure ADSL/ATM VPI and VCI

Syntax [no] pvc <VPI/VCI>

Context [xDSL Port Configuration](#) context (only available when ADSL mode is used, see [section 13.3.2](#))

Usage Specify the VCI and VPI used for the ATM PVC by your ADSL provider.

Some examples: **"pvc 0/38"** is common in U.K., **"1/32"** is common in Germany, while **"pvc 8/35"** is common for many other ADSL providers inside and outside Europe.

Use **"no pvc"** to reset the PVC to use default VPI/VCI. (In future versions of WeOS the use of **"no pvc"**, as well as the default PVC setting, may change.)

Use **"show pvc"** to show the ATM PVC setting, i.e., which VPI and VCI are configured.

Default values "pvc 8/35"

13.3.6 Show xDSL port status

Syntax `show dsl`

Context Admin Exec context.

Usage Show the status of all xDSL ports.

Default values Not applicable.

Example

```
falcon:/#> show dsl

Port, DSL mode       : DSL 1, ADSL/Anx-A
Channel, role        : channel 0, role CPE
Link state, uptime   : UP, 0 Days 0 Hours 7 Mins 15 Secs
Negotiation state    : Sync state, 4 changes since boot
Remote vendor name   : GSPN
Downstream -----
Rate                 : 8000 kbps
SNR                  : 12.5 dB
Line attn            : 8.3 dB
Signal attn          : 8.2 dB
Output power:       : N/A
Upstream -----
Rate                 : 832 kbps
SNR                  : 12.0 dB
Line attn            : 7.0 dB
Signal attn          : 7.0 dB
Output power:       : 12.4 dB
falcon:/#>
```

Chapter 14

Power Over Ethernet (PoE)

Some WeOS Viper products[62, 64, 66] have Ethernet ports with support for Power Over Ethernet (PoE[24] and PoE+[25]).

This chapter gives an overview of PoE support in WeOS products (section 14.1). Sections 14.2 and 14.3 concern PoE management support via the Web interface and CLI. PoE related SNMP support is covered in chapter 6, while management of PoE alarms/events is documented in chapter 25.

As of WeOS v4.33.0, PoE management via LLDP[25] is not supported.

14.1 Overview of Power over Ethernet (PoE)

Feature	Web	CLI	General Description
<u>Per-Port PoE Configuration</u>			
Enable/Disable	X	X	
Allocation Priority	X	X	Section 14.1.2
Power Limit	X	X	-"-
<u>PoE Status</u>			
Consumed power	X	X	
Allocated Power	X	X	Sections 14.1.1-14.1.2
Detected PoE Units	X	X	Section 14.1.1

14.1.1 PoE Power Classes

When plugging in a PoE unit to a PoE port on the switch, the switch will detect the class of the connected PoE unit, depending on the unit's resistance and thereby its maximum power consumption.

Table 14.1 lists the maximum power consumption for units of the different PoE classes, as well as the (somewhat higher) power actually allocated by the switch, which considers cable losses. Thus, when admitting a class 0 unit, the switch allocates 15.4 W to ensure 12.94 W reach the PoE unit.

PoE Class	Max Unit Power Consumption (W) ($P_{class,unit}$)	Allocated Power (W) ($P_{class,alloc}$)
0	12.94	15.4
1	3.84	4.0
2	6.49	7.0
3	12.95	15.4
4	25.50	30.0

Table 14.1: Power allocated to and consumed by units of different PoE classes.

It is also possible to configure a *maximum power limit* on each individual PoE port. When setting a power limit, the *default behaviour* is that the port is allocated the *minimum* of the (a) configured power limit, and (b) the power allocated for attached unit's class (as listed in table 14.1). For example, if a port's power limit is set to 12 W, then 7.0 W is allocated when connecting a class 2 PoE unit, while 12 W is allocated if a class 3 unit is connected. This mode is referred to *class based limit mode*.

For newer PoE products[64, 66] there is an additional limit mode: *forced* limit mode. The forced mode enables the switch to supply power to *non-conformant* Powered Devices or even non-PoE devices. This mode goes beyond specification, but can be convenient in certain system setups. The forced mode drives power on the port even when no classification is done.

For more details on per port power limitation and allocation, see section 14.1.2.

The following additional classification is made for the connected unit depending on resistance:

- *Good*: Ok. A PoE unit is connected. (Resistance within specification of PoE class 0-4.)

- *Open*: Ok. Port not connected. ("Infinite" resistance, i.e., *open* circuit).
- *Short*: Ok, when non-PoE unit is connected. (Resistance determined as *short* circuit.)
- *Low*: The connected unit is detected as a PoE unit and served, although its the resistance is too low to meet the PoE specification (and too high to be determined as short circuit (non-PoE unit connected)).
- *High*: The connected unit is detected as a PoE unit and served, although its the resistance is too high to meet the PoE specification (and too low to be determined as unconnected (open circuit)).

14.1.2 Allocation of PoE Power

The maximum power a PoE switch can deliver is referred to as $P_{switch,max}$. For more information on this maximum output power, see the User Guide of your PoE product, listed in [section 1.5](#). When more power is requested than available, the switch will stop/refuse¹ delivering power on the port(s) with lowest *priority*.

14.1.2.1 Calculating available power, and per-port power limitation

As of WeOS v4.33.0, PoE power is always allocated to handle *max* consumption by all admitted PoE units. For each port, the *max* consumption ($P_{port,max}$) is calculated as the minimum value of:

- ($P_{class,alloc}$): The power allocated to units of the attached class (see right column of [table 14.1](#)).
- ($P_{port-limit}$): The power limit configured for the port (if set), given that limit mode is *class* based (default).

The exception is when a power limit is set with limit mode *forced* ([section 14.1.1](#)); then $P_{port,max}$ is always equal to the configured $P_{port-limit}$.

The available power is calculated as max output power of the switch¹, minus the sum the max power for all (admitted) ports.

$$P_{available} = P_{switch,max} - \sum_{admitted} P_{port,max}$$

¹To compensate for limited accuracy in measured power consumption, your WeOS PoE unit may allow the measured and allocated power to raise somewhat above the stated $P_{switch,max}$ of the product, before power delivery is stopped/refused on some port. The customer should still ensure that PoE equipment attached to the WeOS PoE switch do not use more than $P_{switch,max}$ in total.

If a new PoE unit is attached, its $P_{class,alloc}$ will be compared to $P_{available}$:

- If there is enough power available to serve the new unit, it will be admitted.
- If there is **not enough** power available to serve the new unit, the switch will deliver power to the ports with highest priority (see below). Thus, to admit the new unit, one (or more) of the already admitted units will be declined power.

14.1.2.2 PoE Port Priority

There are three levels of PoE priority (*low, high, critical*), which can be configured per port. If there is not enough power to serve all attached PoE units, preference will be given to ports with higher priority.

In 160 W capable PoE products there exists two power groups, each group capable of driving 80 W. The PoE port priority is handled within each group along the same principles as with products with one power group.

As situations can occur where the switch must chose between two ports of the same level of *configured priority*, there is a need for a second level "tie-break" priority. This tie-break priority is allocated in ascending port order, giving the lowest PoE port the highest tie-break priority. The "tie-break" priority is as follows (starting with the highest tie-break priority):

- 12-port Viper PoE units[62, 64]: X1(1), X2(2), X3(3), X5(4), X6(5), X7(6), X9(7), X10(8)
- 20-port Viper PoE units[66]: X5(1), X6(2), X7(3), X11(4), X12(5), X13(6), X17(7), X18(8)
- Viper 20-port 160 W capable PoE units: Power group 1: X3(1), X4(2), X9(3), X10(4), Power group 2: X5(1), X6(2), X7(3), X11(4), X12(5), X13(6), X17(7), X18(8)

The tie-break priority order may become configurable in future WeOS releases.

Table 14.2 illustrates the power allocation preference order in a specific configuration example on a 12-port Viper PoE unit, where ports X7-X10 have been configured with priority *critical*, X5-X6 with priority *high*, and X1-X3 have priority *low*.

Preference Order	Port Name	Configured Priority	Tie-break Priority
1 (highest)	X7	critical	6
2	X9	critical	7
3	X10	critical	8
4	X5	high	4
5	X6	high	5
6	X1	low	1
7	X2	low	2
8 (lowest)	X3	low	3

Table 14.2: Example of allocation preference order for a given PoE priority configuration on a 12-port Viper PoE unit[64].

14.2 Managing PoE via the web interface

The Web interface provides configuration of PoE ports as well as listing of global and port specific PoE status.

14.2.1 List PoE Settings

Menu path: Configuration ⇒ PoE

When entering the PoE configuration page you will be presented to a list of all PoE ports available on your switch, and their settings.

Power over Ethernet Configuration

PoE Port Settings

Port	PoE Enabled	Priority	Limit (W)	Limit Mode	
X1	✓	Low	10	Forced ⚠	
X2	✓	High	5	Class	
X3	✓	Low	5	Class	
X5	✓	Low	Disabled	N/A	
X6	✓	Low	Disabled	N/A	
X7	✓	Low	Disabled	N/A	
X9	✓	Low	Disabled	N/A	
X10	✓	Low	Disabled	N/A	

Port	The port label. (Only PoE capable Ethernet ports are listed.)
PoE Enabled	Shows if PoE is enabled or disabled on the port.
Priority	Shows the configured PoE priority (Low, High or Critical) for the port.
Limit	Shows the configured Power Limit for the port (in Watts), or Disabled if no port specific limit has been set.

Continued on next page

Continued from previous page	
Limit Mode	Shows the configured Power Limit Mode setting for the ports.
 Edit	Click this icon to edit a port's PoE settings.

14.2.2 Edit PoE Port Settings

Menu path: Configuration ⇒ PoE ⇒ 

Port X1 - Power over Ethernet

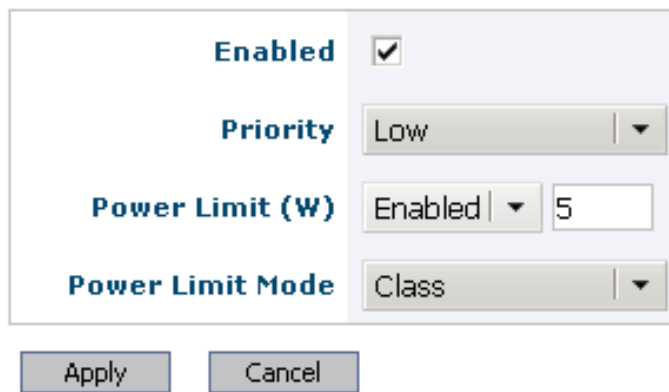

The screenshot shows a configuration window for Port X1. It contains the following settings:

- Enabled:** A checkbox that is checked.
- Priority:** A dropdown menu currently showing 'Low'.
- Power Limit (W):** A dropdown menu showing 'Enabled' and a text input field containing the number '5'.
- Power Limit Mode:** A dropdown menu currently showing 'Class'.

At the bottom of the window are two buttons: 'Apply' and 'Cancel'.

On this page you can change the PoE settings for the port.

Enabled	Enable/disable PoE on the port
Priority	PoE power allocation priority. When more power is requested than available, power will be dropped on the ports with lowest priority. Possible values: <ul style="list-style-type: none"> • Low (Shut down first) • High • Critical (Shut down last) See section 14.1.2 for more information.
Power Limit	Set port specific power limit. Allowed values are 1-30 (Watts), or Disabled (i.e., no port specific power limit).
Power Limit Mode	Set port specific power limit mode. See section 14.1.1 for details.

14.2.3 PoE Status

Menu path: Status ⇒ PoE

On the PoE port status page you will be presented to global and port specific PoE status data.

Power over Ethernet (PoE) Status and Statistics

Global Status

Maximum Power (W)	61.6
Allocated Power (W)	0
Consumed Power (W)	0
Power Usage (%)	0

Port Status

Port	PoE Enabled	Priority	Power Limit (W)	Class	Consumed Power (W)	Detection Details
X1	✓	Low	Disabled	Unknown	0	Short
X2	✓	Low	Disabled	Unknown	0	Open
X3	✓	High	3	Unknown	0	Open
X5	✓	Low	Disabled	Unknown	0	Open
X6	✓	Low	Disabled	Unknown	0	Open
X7	✓	Low	Disabled	Unknown	0	Open
X9	✓	Low	Disabled	Unknown	0	Open
X10	✓	Low	Disabled	Unknown	0	Open

Auto refresh: Off, 5s, 15s, 30s, 60s

Refresh

Global Status	
Maximum Power	The maximum power (in Watts) the switch is able to deliver.
Allocated Power	Allocated power (in Watts). See section 14.1.2 for information on allocation and classes.
Consumed Power	The total power consumed on all PoE ports.
Power Usage	Percentage of available power currently consumed (i.e., "Consumed Power"/"Maximum Power").

Port Status	
Port	The PoE port label.
PoE Enabled	Shows if PoE is enabled or disabled on the port.
Priority	Shows the configured PoE priority (Low, High or Critical) for the port.
Power Limit	Shows the configured power Limit for the port (in Watts), or Disabled if no port specific limit has been set.
Class	Shows the PoE class (0-4) of the connected PoE unit, or Unknown if the class cannot be determined.
Consumed Power	Currently consumed power (in Watts) by the connected PoE unit.
Detection Details	Additional details on the unit connected to the PoE port (see also the Class column): <ul style="list-style-type: none"> • Unknown: Unit Resistance Unknown (e.g. PoE disabled on port) • Short: Non-PoE unit connected • Low: PoE Unit connected. Resistance OK, but low • Good: PoE unit connected. Resistance Good. • High: PoE Unit connected. Resistance OK, but high • Open: Nothing Connected
Auto Refresh	Click on a value to make the page reload with updated status automatically every 5, 15, 30 or 60 seconds. Click Off to turn off auto refresh.
Refresh	Click on this button to reload with updated status.

14.3 Managing PoE via the CLI interface

Command	Default	Section
<u>Configure PoE settings</u>		
poe		Section 14.3.1
[no] port <PORTLIST all>		Section 14.3.2
[no] enable	Enabled	Section 14.3.3
[no] priority <low high critical>	Low	Section 14.3.4
[no] limit <1-30>	Disabled	Section 14.3.5
[no] limit-mode <class forced>	Class	Section 14.3.6
<u>Show PoE status</u>		
show poe [full] [port <PORTLIST>]		Section 14.3.7

14.3.1 Manage PoE Settings

Syntax poe

Context [Global Configuration](#) context.

Usage Use command **"poe"** to enter PoE configuration context.

Use **"show poe"** to list global PoE settings and per-port PoE settings, also available as **"show"** command within the PoE configuration context.

Default values Not applicable.

14.3.2 Manage per-port PoE settings

Syntax [no] port <PORTLIST|all>

Context [PoE configuration](#) context.

Usage Enter PoE Port configuration context.

Use **"port <PORTLIST>"** to configure per-port settings for the PoE ports in the given list, e.g., **"port X2"**, or **"port X1-X5,X10"**. Use **"port all"** to configure per-port settings for all PoE ports.

Use **"no port <PORTLIST>"** to reset PoE port settings to their default values for the given port range.

Use **"show"** to list global PoE settings and per-port PoE settings. Use **"show port <PORTLIST|all>"** to show port specific settings for some or all PoE

ports (also available as **"show"** command within the PoE Port configuration context).

Default values Not applicable

14.3.3 Enable/Disable PoE on a PoE port

Syntax [no] enable

Context [PoE Port configuration](#) context.

Usage Enable/disable PoE on this port. Use **"enable"** to enable, and **"no enable"** to disable PoE on this port.

Use **"show enable"** to show whether PoE is enabled (or disabled) on this port.

Default values Enabled (**"enable"**)

14.3.4 Set PoE allocation priority

Syntax [no] priority <low|high|critical>

Context [PoE Port configuration](#) context.

Usage Configure PoE allocation priority setting (**"priority low"** is the lowest priority, while **"priority critical"** is the highest .

"no priority" will reset priority to default (**"priority low"**).

See [section 14.1.2](#) for information on how to select between ports of the same configured priority.

Use **"show priority"** to show PoE allocation priority setting on this port.

Default values Low (**"priority low"**)

14.3.5 Set PoE Power Limit

Syntax [no] limit <1-30>

Context [PoE Port configuration](#) context.

Usage Configure specific PoE Power limit (in Watts) on this port, e.g., **"limit 20"** to limit the delivered power to 20 Watts. The **"limit"** setting behaviour depends on the related limit-mode setting ([section 14.3.6](#)). For more information, see [section 14.1.1](#).

Use **"no limit"** to remove port specific power limits (max power based solely on $P_{class,alloc}$).

Use **"show limit"** to show PoE power limit setting on this port.

Default values Disabled (**"no limit"**)

14.3.6 Set PoE Power Limit Mode

Syntax [no] limit-mode <class|forced>

Context PoE Port configuration context.

Usage The limit setting consists of two modes; *class* and *forced*. The **"limit-mode"** is only applicable for ports with a power **"limit"** set (section 14.3.5). For more information, see section 14.1.1.

Use **"no limit-mode"** to reset it to its default, i.e., class.

Use **"show limit-mode"** to show the current setting.

Default values Class (**"no limit-mode"**)

14.3.7 Show PoE Status

Syntax show poe [full] [port <PORTLIST>]

Context Admin Exec context.

Usage Show PoE global and per port status.

Use **"show poe"** (or **"show poe port <PORTLIST>"**) to list global PoE status information, and a status summary for all PoE ports (or a given subset).

Use **"show poe full"** (or **"show poe full port <PORTLIST>"**) to list global PoE status information, and detailed status information for all PoE ports (or a given subset).

Default values Not applicable

Chapter 15

Virtual LAN

WeOS supports static port based VLANs and VLAN tagging according to IEEE 802.1Q[22]. Adaptive VLAN Trunking (AVT) can be used to simplify VLAN configuration in larger WeOS networks.

Stacked IEEE 802.1Q tags (Q-in-Q)¹ are also supported. This allows for creation of Layer 2 connections between sites while still allowing a full range of VLANs – that may overlap – for internal use at each site. One use case is to bundle different VLANs over a single service VLAN.

[Section 15.1](#) provides general information about the VLAN properties and VLAN management features in WeOS. This section also covers features available to manage and inspect the MAC forwarding database on WeOS devices.

[Section 15.3](#) covers VLAN settings via the Web interface, and [section 15.4](#) covers VLAN and MAC forwarding database settings via the CLI.

15.1 Overview of VLAN Properties and Management Features

[Table 15.1](#) summarises VLAN management features in WeOS. [Section 15.1.1](#) provides general VLAN information and [sections 15.1.2-15.1.6](#) contain further information on specific VLAN features.

¹This is not the same as IEEE 802.1ad, which may also be referred to as Q-in-Q.

Feature	Web	CLI	General Description
<u>General VLAN functionality</u>			
Enable/disable dynamic VLAN	X	X	Sec. 15.1.7
<u>Per VLAN functionality</u>			
Add/modify/delete VLAN	X	X	Secs. 15.1.1-15.1.3
Enable/disable VLAN	X	X	
VLAN name		X	
Untagged/Tagged ports	X	X	Sec. 15.1.1
VLAN priority	X	X	Sec. 15.1.4
IGMP Snooping	X	X	Sec. 15.1.5
VLAN CPU Channel		X	Sec. 15.1.6
Forwarding Database		X	Sec. 15.1.8
Forbid ports	X	X	Sec. 15.1.7
Port-based network access control	X	X	Sec. 15.2
View VLAN settings	X	X	
View VLAN status	X	X	
<u>MAC forwarding database functionality</u>			
Set MAC aging timeout		X	Sec. 15.1.8
Set static MAC filters		X	Sec. 15.1.8
Set PROFINET Pass-through		X	Sec. 15.1.8
View forwarding database settings		X	
View forwarding database status		X	

Table 15.1: Summary of VLAN management features.

15.1.1 Introduction to VLANs

Virtual LAN (VLAN) technology is used to create a set of separate LANs over a single physical LAN infrastructure. Each VLAN constitutes a broadcast domain, and traffic on one VLAN is (logically) isolated from traffic on another VLAN. WeOS supports creation of static port based VLANs and VLAN tagging as described further in this section. We start with two examples to explain the terms *untagged* and *tagged*.

[Fig. 15.1](#) shows a situation where three networks, the *ADMIN* VLAN, the *OFFICE*

VLAN, and the *MARKETING* VLAN share a single switch.

- Each VLAN is assigned a VLAN identifier, a VLAN ID (VID); in this example VIDs 1 (*ADMIN*), 2 (*OFFICE*) and 3 (*MARKETING*).
- Each VLAN is assigned a set of ports. In this example ports 1/1-1/2 are associated with the *ADMIN* VLAN, Ports 2/1-2/4 with the *OFFICE* VLAN, and ports 2/5-2/8 with the *MARKETING* VLAN.

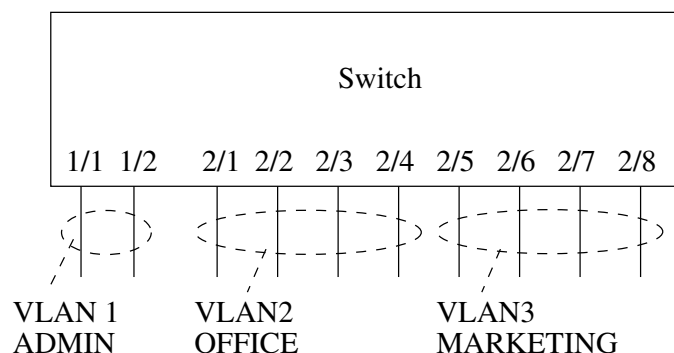

Figure 15.1: VLANs sharing a single switch.

In this example we have assumed that only regular hosts (PCs, servers, etc.; not other switches) attach to the ports of the switch. Traffic sent and received on each switch port are regular Ethernet packets (without VLAN headers), and here we refer to this by saying that the switch ports are associated with their respective VLAN *untagged*.

Note
A port associated *untagged* on a VLAN, will send and receive regular Ethernet packets (i.e., without VLAN header) on that port.

Consider the case where a PC attached to port 2/1 of the switch in [fig. 15.1](#) transmits a *broadcast* packet. That packet will be forwarded onto all other ports of VLAN 2 (*OFFICE*), i.e., ports 2/2-2/4, but not to any of the other ports.

[Fig. 15.2](#) shows a situation where three networks, the *ADMIN* VLAN, the *OFFICE* VLAN, and the *MARKETING* VLAN share two switches as well as the connection between them.

- As in the previous example, each VLAN is assigned a VID; in this example VIDs 1 (*ADMIN*), 2 (*OFFICE*) and 3 (*MARKETING*).

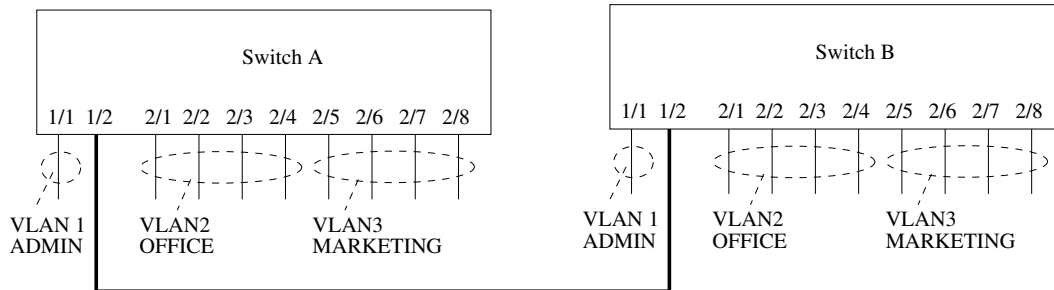

Figure 15.2: VLANs sharing two switches and the connection between them.

- Each VLAN is assigned a set of ports. (For simplicity of this example, we have chosen to use the same port assignment on both switches.) Port 1/1 is associated (untagged) with the ADMIN VLAN, Ports 2/1-2/4 are associated (untagged) with the OFFICE VLAN, and ports 2/5-2/8 are associated (untagged) with the MARKETING VLAN.

In addition, port 1/2, where the cable between the two switches is connected, is associated with all three VLANs. In order for the switches to distinguish which VLAN a packet belongs to when transmitted over a shared connection, the switch will insert a VLAN header (VLAN tag) into the packet, which includes information about the VLAN ID (here 1, 2 or 3). Thus, in this example port 1/2 would be associated with VLAN 1, 2 and 3 *tagged*².



Note

A port associated *tagged* on a VLAN, will send and receive *tagged* Ethernet packets (i.e., Ethernet packets including a VLAN header) on that port.

Consider the case where a PC attached to port 2/1 of *switch A* in [fig. 15.2](#) transmits a *broadcast* packet. That packet will be forwarded onto ports 2/2-2/4 of *switch A* *untagged*, and onto port 1/2 of *switch A* *tagged* with VID 2. When the *tagged* packet is received on port 1/2 on *switch B*, that switch can determine that the packet belongs to VLAN 2, and will forward it onto ports 2/1-2/4 *untagged*.



Note

A port cannot be associated with more than one VLAN *untagged*. A port cannot be associated both *untagged* and *tagged* with the same VLAN.

²It is recommended that a port, which is shared between several VLANs, is associated *tagged* with all those VLANs, however, it is possible to configure the port *untagged* on one VLAN and *tagged* on all other VLANs without risk for ambiguity.

We refer to the VLAN with VID 1 as the *switch default VLAN*. Ports not associated with any VLAN (*untagged* or *tagged*) will automatically be associated with the default VLAN. [Section 15.1.3](#) provides more information on the *default VLAN*.

For each VLAN on a switch, an associated network interface will be created. The name of a VLAN network interface is *vlan<VID>*, e.g., *vlan1* for VLAN 1, and *vlan100* for VLAN 100. The network interface can be assigned an IP address (IPv4), and the switch can then be managed remotely via that VLAN. It is also possible to *route* IP traffic between network interfaces. For more information on network interfaces and routing, see [chapter 22](#).

Internally, a WeOS switch can have one or more *channels* to the CPU, where each channel has a capacity of 100 Mbit/s or 1000 Mbit/s. [Section 15.1.6](#) describes how VLANs can be mapped to different CPU channels to achieve increased routing performance.

Layer-2 priority was described in a previous chapter, see [section 10.1.4](#). In addition to different per port priority settings, it is possible to assign specific layer-2 priority per VLAN, see [section 15.1.4](#).

The switch supports efficient distribution of IP multicast packets by use of *IGMP snooping*. See [section 15.1.5](#) for more information on per VLAN IGMP snooping features.

The switch provides support for dynamic VLANs by WeOS Adaptive VLAN Trunking (AVT). AVT can be used to simplify VLAN configuration in larger WeOS LAN infrastructures. AVT is described further in [section 15.1.7](#).

15.1.2 Supported number of VLANs and VLAN integrity

Every VLAN needs to be associated with a unique VLAN ID (VID).

- Switches *support* configuration of up to 64 simultaneous VLANs³.
- Valid VIDs for configuration are in range 1-4094.
- Some VLAN IDs are reserved for specific use - currently this concerns a set of VIDs in use by the FRNT protocol, see [section 16.1.5](#).

Switches only accept packets for VLANs to which the inbound port is associated. Additional rules for accepting a packet is described below:

³Special restriction on DDW-x42/DDW-x42-485: On these products the limit is 60 VLANs when FRNT is configured on the unit, and 64 VLANs when FRNT is not configured.

- When an untagged packet is received on a port, that packet will be mapped to the port's default VID. If the port is associated with that VLAN (tagged or untagged), the packet will be accepted, otherwise dropped.
- The port's default VID will be the VID of the VLAN to which the port is associated *untagged*. If the port is not associated *untagged* to any VLAN, the default VID is set to the *fall-back default-VID* (see also [section 10.1.12](#)) if configured, otherwise to VID 1.
- *Priority tagged* packets, i.e., packets with VID 0, will be associated with the port's default VID.
- Typically *tagged* packets (VID in range 1-4094) or priority tagged packets (VID 0) are only accepted on ports where there is at least one VLAN associated *tagged*. In addition, the packet will only be accepted if the inbound port is associated (*untagged* or *tagged*) the VLAN of the packet.

A common MAC address database is used for all VLANs (shared VLAN learning).

15.1.3 Switch default VLAN

In WeOS the VLAN with VID 1 (VLAN 1) is denoted as the *switch default VLAN*. Ports not associated with any VLAN (neither *untagged* nor *tagged*) will automatically be configured *untagged* to the switch default VLAN. This could happen when a port is removed from a VLAN, or when a whole VLAN is removed.



Note

The main purpose of the switch default VLAN is to avoid loss of remote manageability of a switch due to a change in the VLAN configuration. *Without* a default VLAN, you risk to lose remote access to the switch if the ports used to connect to the switch are removed from all VLANs (unintentionally or deliberately).

With the default VLAN feature, the switch is still manageable via those ports, given that proper IP and firewall settings are configured for the network interface associated with the switch default VLAN.

The switch default VLAN cannot be removed. However, it is possible to remove all ports from the default VLAN by assigning them to other VLANs.

15.1.4 VLAN Priority

It is possible to assign an IEEE 802.1p priority to a VLAN. This feature can be useful when an operator likes to assign a higher priority to traffic on a certain VLAN, e.g., a VLAN dedicated for IP telephony.

When a *VLAN priority* is configured, all packets associated with that VLAN will be treated according to the given VLAN priority, rather than basing the packet's priority on VLAN tag priority, IP ToS/DiffServ or inbound port identifier. For more information on layer-2 priority, see [section 10.1.4](#).

15.1.5 IGMP Snooping and VLANs

Switches use IGMP snooping for efficient distribution of IP(v4) multicast over the LAN. With IGMP snooping *enabled* on a VLAN, the switch keeps track IP Multicast subscriber and limits forwarding of such "known multicast" to ports leading to subscribers.

By default IGMP snooping is enabled on each newly created VLAN. More information on IGMP Snooping and IGMP Snooping settings is found in [chapter 21](#).

15.1.6 Mapping VLANs to a CPU channel

A switch can have one or more channels to the switch CPU, each with a capacity of 100 Mbit/s or 1000 Mbit/s⁴. By default every new VLAN (with a network interface) is mapped to CPU channel "0" (zero).

On devices with multiple CPU channels increased routing performance may be achieved by assigning different VLANs to different CPU channels. Assume VLANs 1 and 2 are mapped to the same CPU channel of 100 Mbit/s capacity. Then the maximum theoretical routing throughput between the two VLAN interfaces is 50 Mbit/s full duplex, while the maximum theoretical routing throughput would be 100 Mbit/s full duplex if these VLANs were mapped to different CPU channels.

**Note**

Routing performance may also be limited by CPU performance, packet size and enabled services.

⁴WeOS products with "Corazon" or "Coronet" platform (see [section 1.5](#)) have 1000 Mbit/s channels to CPU, while others have 100 Mbit/s channels.

A VLAN can only be mapped to a single CPU channel.

15.1.7 Dynamic VLANs

WeOS provides dynamic VLAN support via the WeOS Adaptive VLAN Trunking (AVT) protocol. With AVT enabled, VLAN configuration on *inter-switch links* is simplified - once a switch detects that it is connected to another switch, all VLANs defined on the local switch will automatically be added to that port, see [fig. 15.3](#).

Future versions of WeOS may include dynamic VLAN support via the standard IEEE GVRP[22] protocol in addition to AVT.

15.1.7.1 Determining Inter-Switch Ports

To determine if a port on a switch is connected to another switch, AVT will utilise information from the FRNT and RSTP protocols:

- *FRNT*: If FRNT is enabled on the switch, any port configured as an FRNT port will be classified as an inter-switch port by AVT. If FRNT is disabled, or if the FRNT port configuration is changed, AVT will adapt its inter-switch port classification accordingly. For more information on FRNT, see [chapter 16](#).
- *RSTP*: If RSTP is enabled on a port, AVT will consider the reception of an RSTP or STP message as a sign that it is connected to another switch on the receiving port. The port will continue to be classified as an inter-switch port until the link goes down or until RSTP is disabled on that port. For more information on RSTP, see [chapter 18](#).

15.1.7.2 Dynamic addition/deletion of VLANs to Inter-Switch Ports

Once a port has been defined as an inter-switch port, that port will dynamically be associated (tagged) with all VLANs *configured on the switch*. The exception is when that port has been configured in association mode *forbid* on some VLAN(s) - the port will *not* be associated with those VLANs.

Further details of the mechanism to associate VLANs dynamically to an inter-switch port are given below:

- *Association mode of dynamically added VLANs*: All VLANs configured on the switch will be associated *tagged* by AVT. This applies even to those VLANs configured *untagged* on that port. [Fig. 15.3](#) shows an example.

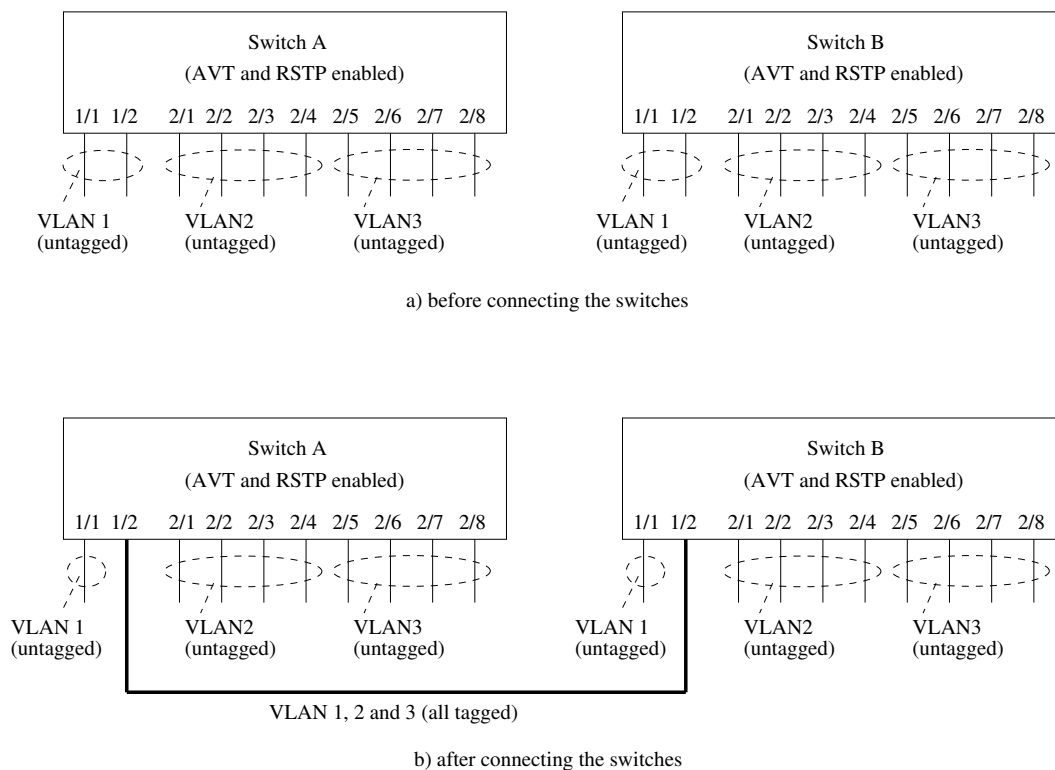

Figure 15.3: Using Adaptive VLAN trunking (AVT) to dynamically add VLANs to inter-switch ports.

Note

As AVT only considers the VLANs configured on the (local) switch when adding VLANs to an inter-switch port, the operator of the LAN infrastructure should ensure that all switches have the same set of VLANs defined. Otherwise the VLANs forwarded by different switches will be inconsistent, resulting in lack of full connectivity on some VLAN(s).

- *Removing dynamically added VLANs:* When a port loses its status as inter-switch port, all VLANs dynamically added to that port will be removed. The port will then only be associated with the VLANs it has been configured with, and with association mode (tagged or untagged) according to the configuration.
- *Prohibiting that a VLAN is added to a port:* It is possible to prohibit that

some VLAN(s) is dynamically added to a port even when AVT is enabled. This feature is useful when the unit acts as a routing switch, where traffic between some ports should be *routed* rather than *switched*.

To prohibit that a VLAN is dynamically added to a port, that port should be configured with association mode *forbid* on that VLAN.

As of WeOS version v4.33.0 the *forbid* association mode only hinders a port to be added to a VLAN dynamically via AVT. Ports not configured untagged/tagged with any VLAN will still be mapped to the switch default VLAN (VLAN 1), irrespective if that port is configured as *forbid* on VLAN 1. For more information about the switch default VLAN, see [section 15.1.3](#).

15.1.7.3 Prohibit disabling of Inter-Switch Ports

A port determined as inter-switch port by AVT will not be possible to disable by management (Web, CLI, SNMP, etc.). This feature is added in order to avoid unintentional loss of connectivity to the switch.

15.1.8 MAC forwarding database

All switches maintain a MAC forwarding database (FDB) with information about where to forward Ethernet frames for each known MAC address. By default, a single FDB is used for all VLANs, commonly referred to as *shared VLAN learning* in [22].

For some use-cases, in particular Q-in-Q tunneling (see [section 15.1.9](#)), it may be beneficial to have a separate (unique) forwarding database per VLAN. To that end the CLI VLAN configuration context has an FDB setting which can be set to any value between 0 and 63. Providing ample opportunity to set up any combination of shared and unique FDB for all VLANs.

However, as of WeOS v4.33.0 this per VLAN FDB setting is still a technology preview, as such it may not be applicable to all possible use-cases. For instance, the following factory enabled services are recommended to be disabled for all VLANs, and ports, with a non-default FDB setting: IGMP, and LLDP.

15.1.8.1 Managing Unicast MAC addresses

When the switch comes up, it will not know which stations are attached to its ports. The switch inspects the destination MAC address of each incoming packet

without finding a match in the forwarding database - unknown unicast MAC addresses will be broadcasted on all ports of the associated VLAN.

The switch will automatically learn the location of stations in the LAN, by inspecting the source MAC address of each incoming packet. Once it knows on which port a certain MAC address resides, all future packets to that station will be forwarded only onto that port.

**Note**

Switches "learn" the location of (unicast) MAC address by inspecting the "source" MAC address, while they "forward" packets based on the "destination" MAC address.

Unicast MAC addresses learnt automatically will stay in the MAC forwarding database until they are aged out – the aging timeout defaults to 300 seconds. The aging timeout is configurable, and aging can be disabled.

15.1.8.2 Managing Broadcast and Multicast MAC addresses

Packets transmitted to the *broadcast MAC address* ("ff:ff:ff:ff:ff:ff") will be forwarded onto all ports in the associated VLAN. Other group MAC addresses (here referred to as multicast MAC addresses) are handled differently if *IGMP Snooping* and *flooding of unknown multicast* are enabled or not, please see [chapter 21](#) for detailed information.

WeOS also allows an operator to manually specify where to forward multicast MAC addresses, i.e., the operator can add *static multicast MAC filters*.

When specifying the destination port list in a MAC filter, one can specify both regular Ethernet (and DSL) ports, as well as the internal CPU port(s) of the switch. The latter is used if the multicast packet should be processed by the switch itself.

15.1.9 VLAN Q-in-Q tunneling

The concept of VLAN tunneling can be used over any switched network where VLAN trunking is already used.

Figure 15.4 shows the basic setup to illustrate the use of Q-in-Q tunneling⁵. It depicts two customers, which use identical VLANs on each respective network, that want to connect their two sites over a shared provider network.

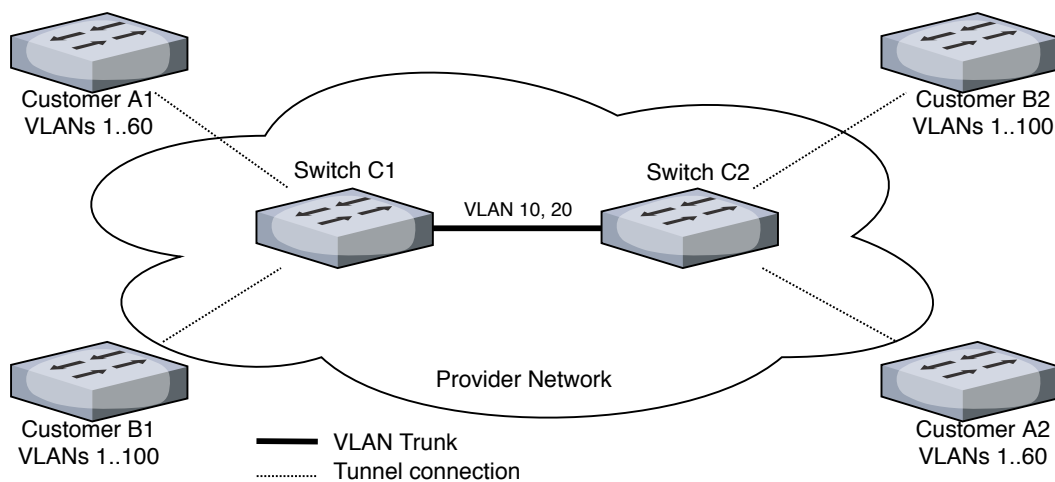

Figure 15.4: Q-in-Q Tunneling Setup Overview.

The chosen example may at first glance only apply to traditional Internet Service Providers (ISP). However, the same model can also be applied to industrial networks where isolation and tunneling over a shared network infrastructure is required.

⁵WeOS implements Q-in-Q using stacked IEEE 802.1Q VLAN tags, not provider tagging according to IEEE 802.1ad, which may also be referred to as Q-in-Q.

15.1.9.1 Setup

This section details how to set up the two core switches to encapsulate and segregate traffic from the two customers. The core switches have the same identical configuration:

- Two extra customer VLANs, VLAN 10 and 20
- One VLAN trunk, for the provider network
- A unique MAC/forwarding database (db) for each customer VLAN
- Disable IEEE 802.1Q VLAN ingress filtering, i.e. allow any (inner) VLAN ID for inbound frames on the customer's access ports
- No switch CPU connection to customer VLANs

The last point warrants further discussion. In WeOS the switch CPU is by default a member of all VLANs. This makes configuration easier and reduces the risk of losing connection to the device. There are, however, security aspects to this so it is strongly recommended to disable this for all non-management VLANs.

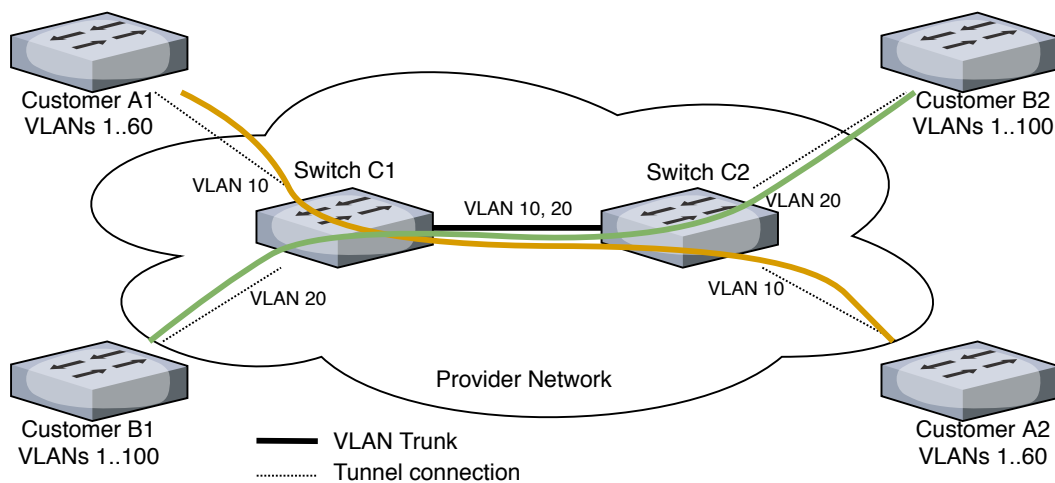

Figure 15.5: Q-in-Q Tunneling Setup.

15.1.9.2 Configuration

First we add the two VLANs, one untagged port as access port for the customer, and one tagged port for the provider backbone connection. We also give each VLAN a unique MAC/forwarding db (fdb). The provider backbone in this example is the VLAN trunk, port Eth 10.

Example

```
example:/#> configure
example:/config/#> vlan 10
example:/config/vlan-10/#> untagged eth 3
example:/config/vlan-10/#> tagged eth 10
example:/config/vlan-10/#> fdb 10
example:/config/vlan-10/#> end
example:/config/#> vlan 20
example:/config/vlan-20/#> untagged eth 5
example:/config/vlan-20/#> tagged eth 10
example:/config/vlan-20/#> fdb 20
example:/config/vlan-20/#> end
example:/config/#>
```

Note: Setting a unique MAC/forwarding db for a VLAN is only supported for Q-in-Q tunneling cases. WeOS services like IGMP snooping, LLDP, etc. are currently not supported for such VLAN configurations and should be disabled.

For the customer access ports we need to disable IEEE 802.1Q VLAN ingress policy. This allows the customer to use any VLAN ID on their internal network. All ingressing traffic on these access ports will be encapsulated with a second VLAN tag, VID 10 and 20, respectively. The encapsulating VLAN is configured using the `default-vid` setting:

Example

```
example:/config/#> port eth 3
example:/config/eth-3/#> no dot1q
example:/config/eth-3/#> default-vid 10
example:/config/eth-3/#> end
example:/config/#> port eth 5
example:/config/eth-5/#> no dot1q
example:/config/eth-5/#> default-vid 20
example:/config/eth-5/#> end
```

To ensure complete isolation of the Q-in-Q tunnels, we remove the core switch CPU connection from each of the customer VLANs:

Example

```
example:/config/#> iface vlan10  
example:/config/iface-vlan10/#> no enable  
example:/config/iface-vlan10/#> end  
example:/config/#> iface vlan20  
example:/config/iface-vlan20/#> no enable  
example:/config/iface-vlan20/#> end  
example:/config/#> leave
```

The tunnel isolation step (above) only disables the switch CPU layer-3 connection, we also need to disable WeOS default layer-2 services like IGMP snooping and LLDP.

Example

```
example:/#> configure  
example:/config/#> vlan 10  
example:/config/vlan-10/#> no igmp  
example:/config/vlan-10/#> end  
example:/config/#> vlan 20  
example:/config/vlan-20/#> no igmp  
example:/config/vlan-20/#> end  
example:/config/#> lldp  
example:/config/lldp/#> port 3,5  
example:/config/lldp/port-eth3,5/#> no enable  
example:/config/lldp/port-eth3,5/#> leave  
example:/#> copy run start
```

15.1.9.3 Guidelines & Limitations

WeOS Q-in-Q tunnels have the following configuration guidelines and limitations:

- All core switches in the provider network must support the increase in MTU size due to the extra four byte VLAN tag used in Q-in-Q tagging. All current WeOS switches are capable of up to 1632 bytes frame size
- Remember, a VLAN Q-in-Q tunnel does not encapsulate the Ethernet header, nor does it provide any encryption
- It is strongly recommended to use a separate MAC/forwarding database (fdb) for each Q-in-Q tunnel, in the example used in this document this means one FDB per customer, see figure 15.5. This protects, for example, against MAC address reuse, which is a common problem in industrial networks
- Disable default services like IGMP snooping and LLDP on VLANs and ports used for Q-in-Q tunnels

15.1.9.4 Default Pass-through of PROFINET Multicast

WeOS supports seamless pass-through of PROFINET multicast by default. It can be disabled if needed, as shown below, but is best left enabled:

 **Example**

```
example:/#> configure
example:/config/#> fdb
example:/config/fdb/#> no profinet
```

Inspect the FDB using the **"show fdb [id] [full]"** command from [Admin Exec](#) context. The optional **"full"** argument, without brackets, lists all entries without any filtering of the output. An optional **"id"** argument can be used to lists entries only in a specific FDB.

PROFINET reserves the 01:0e:cf:00:0X:XX multicast MAC range for signalling purposes, separate from the IPv4 multicast MAC range. With IGMP snooping managing the latter, WeOS can guarantee perfect filtering of all multicast.

 **Note**

It is highly recommended to enable IGMP snooping in PROFINET networks. The two features in concert guard against unsolicited flooding of multicast, which can otherwise be a big problem for end devices in an industrial network. In fact, not only do they protect access ports, but the also prevent flooding on shared VLAN trunks.

15.2 Port-based network access control

WeOS supports port-based network access control (PNAC). This security feature is used to stop unauthorised PCs or other equipment to access the network. Authentication is required to gain access. WeOS provides two authentication methods: *IEEE 802.1X* and *MAC based authentication*.

Ports with access control enabled (i.e., *controlled ports*) will by default be *blocked* for incoming traffic. Only when a connected device has successfully authenticated itself will it be allowed/authorised to send data through the port. Packets from unauthorised devices are still dropped, i.e., only packets with a source MAC address of devices authorised via 802.1X or MAC authentication are allowed.

Incoming broadcast and multicast packets from unauthorised devices will also be blocked. *Outgoing* broadcast and multicast packets will, however, **not** be blocked and are sent out as usual on *controlled ports*. IGMP joining of multicast groups will not work for unauthorised clients, as incoming IGMP join messages are dropped until the client is granted access.

In WeOS, port-based network access control is managed per VLAN. Enabling access control on a VLAN implies that all *untagged* ports on that VLAN are subject to access control by default. Often some or a few ports need to be excluded from access control, e.g., ports connected to a server, uplink ports (towards Internet), and VLAN trunk ports. These ports can be excluded by a special configuration option in the CLI "**except-auth**" (see [section 15.4.20](#)) or in the web GUI (see [section 15.3.5](#)).



Port-based network access control and VLAN trunk ports

As of WeOS v4.33.0, port-based network access control is only working as expected for access ports, i.e., ports only associated with a single VLAN (untagged). VLAN trunk ports (ports associated tagged to one or more VLANs) should be excluded from access control. Although it is possible to have access control enabled on such ports, the behaviour is neither defined nor supported, and may change in future WeOS releases.

In order to acquire access, the connected device needs to authenticate itself to the switch. See [fig. 15.6](#) for a scenario. The PC on port 1 has authenticated itself, whereas the one on port 2 has not. The first PC is able to access the server or the Internet connection on ports 6 and 8. The second PC or anything connected to ports 3 or 4 will be blocked by the switch until they have authenticated themselves.

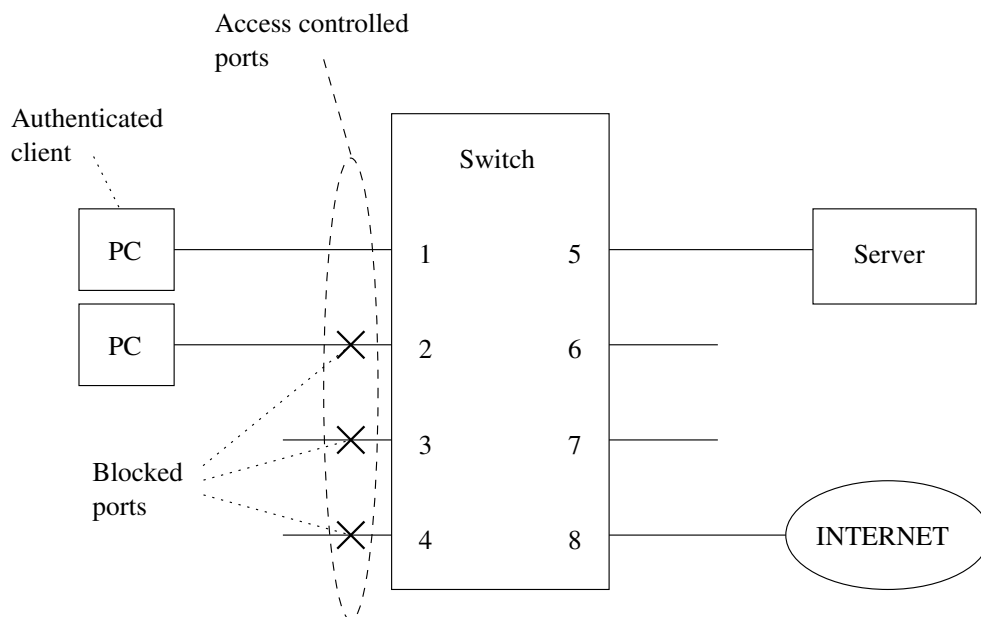

Figure 15.6: Port-based network access control

The two authentication mechanisms available in WeOS for port-based network access control are described further below: *IEEE 802.1X* in [section 15.2.1](#) and *MAC based authentication* in [section 15.2.2](#).

15.2.1 Authentication using IEEE 802.1X

WeOS units are able to act as IEEE 802.1X [23] *authenticators*. WeOS uses the RADIUS[44] protocol with extensions for Extensible Authentication Protocol (EAP[43]) to communicate to a backend *authentication server*.

WeOS neither includes a RADIUS server nor a local authentication server mechanism for 802.1X. Instead the 802.1X authentication server must be provided externally.

WeOS v4.33.0, supports *Authenticator initiation* as defined by §8.1.2.1 in the IEEE 802.1X standard[23] this is enabled by default but can be disabled. (see [Section 9.3.26](#)) If disabled the 802.1X client (*supplicant*) must initiate the authentication procedure to gain access⁶.

[Fig. 15.7](#) illustrates the principles of a successful authentication with IEEE 802.1X.

⁶The 802.1X supplicants included with Microsoft Windows, Ubuntu Linux and most other equipment supports supplicant initiation.

Authentication request with IEEE 802.1X

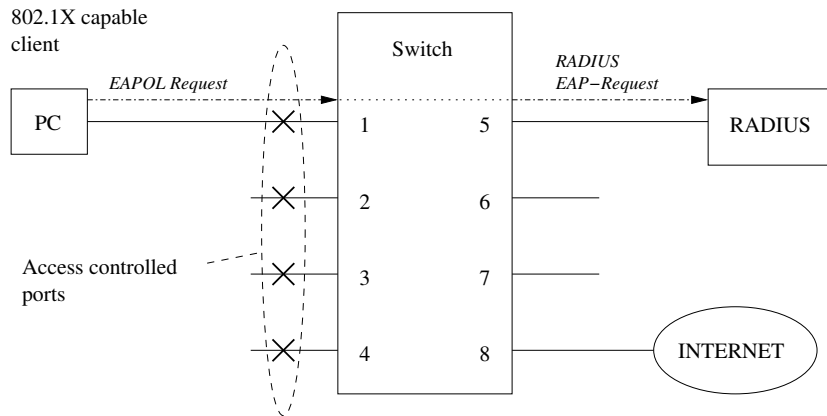

Successful authentication reply with IEEE 802.1X

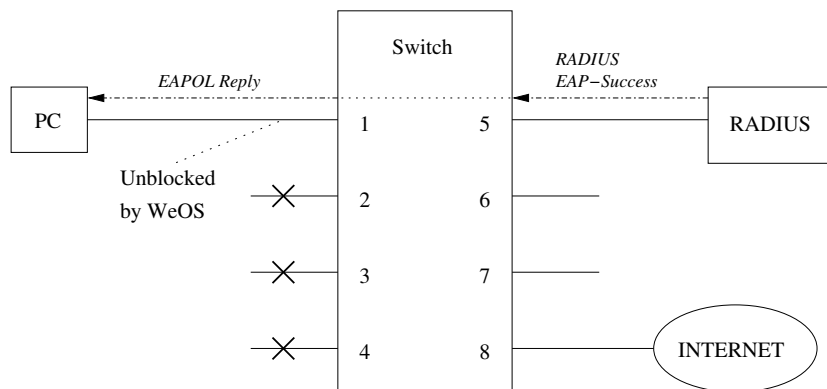

Figure 15.7: Principles of authentication with IEEE 802.1X and RADIUS

In reality the protocol exchanges several messages between the supplicant, the authenticator and the RADIUS backend server (see the standard documents for details). The WeOS unit acts as an IEEE 802.1X authenticator, relaying the EAP messages to the RADIUS server.

When configuring the 802.1X authenticator in WeOS, the RADIUS server (or group of RADIUS servers) must be specified. The procedure is as follows:

1. *RADIUS server settings (AAA):* Enter the appropriate settings for your RA-

DIUS server(s): IP address, password, etc. See [chapter 9](#) on Authentication, Authorisation and Accounting (AAA) for more information.

2. *Define RADIUS server group (AAA)*: (Optional) The RADIUS servers can be grouped together, simplifying configuration in some cases. See [chapter 9](#) on AAA for more information.
3. *Define AAA instance(s) for 802.1X (AAA)*: To allow individual RADIUS servers or server groups to be used as 802.1X authentication backends, they need to be listed in an 802.1X AAA instance. See [chapter 9](#) on AAA for more information.
4. *Enable 802.1X per VLAN*: When 802.1X is enabled on a VLAN, the relevant AAA instance is defined, thereby defining which RADIUS server(s) to relay 802.1X messages to from this VLAN. See sections [15.3.4](#) (Web) and [15.4.18](#) (CLI) for further details.

15.2.2 Authentication based on MAC addresses

Authentication can be based on the client's MAC address. This is often combined with IEEE 802.1X authentication to grant access to 802.1X capable devices and legacy equipment lacking 802.1X support. When combined, MAC authentication will have precedence over 802.1X authentication.

MAC based authentication is not as secure as IEEE 802.1X. Devices are granted access based on the MAC address without any cryptographic authentication exchange, and it is fairly easy to modify the MAC address on a PC and most other equipment.

MAC authentication is set up using lists of one or more MAC address patterns. MAC patterns may contain a wild-card at the end to match a whole range of addresses. Examples: The pattern `00:11:22:33:44:55` matches exactly one address, while the pattern `00:AA:BB:*` matches all addresses beginning with `00:AA:BB`.

When enabling MAC authentication on a VLAN in WeOS, the associated MAC list (white-list) must be specified. The procedure is as follows:

1. *Create MAC Authentication List (AAA)*: Create a MAC list, and add MAC patterns to that list. A MAC pattern by default applies to all ports on the VLAN the MAC list will be mapped to, however, the MAC pattern may apply to a specific port. See [chapter 9](#) on Authentication, Authorisation and Accounting (AAA) for more information, in particular [sections 9.3.28-9.3.31](#) (CLI), and [9.2.20](#) (Web).

2. *Enable MAC authentication per VLAN:* When MAC authentication is enabled on a VLAN, the relevant MAC list is specified, thereby defining which MAC addresses to grant access. Access is granted on all ports, except for MAC patterns limited to a specific port. See sections [15.3.4 \(Web\)](#) and [15.4.18 \(CLI\)](#) for further details.

The switch will listen on the controlled ports for Ethernet packets originating from currently unknown MAC addresses. When such a packet arrives, it will use the packet's source MAC and search through the specified MAC list for a matching entry. If one is found, the port will be opened for the specific MAC address. Packets that do not match will be discarded (alternatively, such packets can be authentication via 802.1X).

A port will remain open for an authorised MAC as long as traffic flows. If no packets is received through the port from an authorised MAC address for 5 minutes⁷, the port will be closed again for this address, and the authentication procedure will be re-done when new packets arrive.

As of WeOS v4.33.0 does **not** support MAC based authentication with a backend authentication server (e.g, RADIUS).

⁷MAC aging time is by default 5 minutes, see [sections 15.1.8.1](#) and [15.4.2](#) for more information.

15.3 Managing VLAN settings via the web interface

Menu path: Configuration ⇒ VLAN ⇒ VLANs

When entering the VLAN configuration page you will be presented to a list of all VLANs configured on your switch, see below. Here you get an overview of the settings for all VLANs and you can create or delete VLANs. The default VLAN (VID 1) cannot be removed (see [section 15.4.7](#)). To change the settings for a specific VLAN, click the edit icon which will take you to the VLAN settings edit page.



VLANS

VID	Name	Enabled	Status	Prio	IGMP	Interface	Port(s)			
							Tagged	Untagged	Dynamic	
1	vlan1	✓	Up	—	✓	vlan1	dsl 1/1, 1/2, eth 2/1, 2/3-2/4			
2	vlan2	✓	Down	3	✓	vlan2	eth 2/3, 2/4	eth 2/2		
3	vlan3	✓	Down	—	—	vlan3	dsl 1/2, eth 2/3			

New VLAN

VID	The VLAN's unique identifier.
Name	The name of the VLAN. Automatically generated from VLAN identifier when the VLAN is created using the web tool.
Enabled	Used to enable or disable a VLAN. Ports on a disabled VLAN are temporarily moved to the system default VLAN. A green check-mark means the VLAN is enabled, and a dash means it is disabled.
Status	Current operational status of the VLAN, Up or Down .
Prio	VLAN priority setting. Values between 0-7 or disabled. See also section 15.1.4 . Disabled is shown using a dash.
IGMP	In the VLAN overview table a green check-mark means that IGMP snooping is enabled, and a dash means it is disabled, on a specific VLAN. See section 15.1.5 for more information.
Interface	A list of associated interfaces.

Continued on next page

Continued from previous page	
Port(s)	List of ports assigned to each VLAN. Grouped as tagged and untagged for ports configured statically to this VLAN, or as dynamic for ports dynamically added to this VLAN by WeOS Adaptive VLAN Trunking (AVT). (See section 15.1.7 for more information on AVT). 1/1-1/3 means port 1/1, 1/2 and 1/3, the first and last port, and all ports in-between.
New VLAN	Click this button to create a new VLAN. You will be presented to a form where you can configure the new VLAN.
 Edit	Click this icon to edit a VLAN.
 Delete	Click this icon to remove a VLAN. You will be asked to acknowledge the removal before it is actually executed.

15.3.1 Edit VLAN settings using the web interface

Menu path: Configuration ⇒ VLAN ⇒ VLANs ⇒ 

When clicking the *Edit* icon for a VLAN you will be presented to the VLAN edit page.

vlan1

VID	1									Slot 1
Enabled	<input checked="" type="checkbox"/>	Port	1/1	1/2						
Name	vlan1	Tagged	<input type="checkbox"/>	<input type="checkbox"/>						
Priority	Disabled	Untagged	<input checked="" type="checkbox"/>	<input checked="" type="checkbox"/>						
IGMP	<input checked="" type="checkbox"/>									Slot 2
		Port	2/1	2/2	2/3	2/4				
		Tagged	<input type="checkbox"/>	<input type="checkbox"/>	<input type="checkbox"/>	<input type="checkbox"/>				
		Untagged	<input checked="" type="checkbox"/>	<input checked="" type="checkbox"/>	<input type="checkbox"/>	<input checked="" type="checkbox"/>				
										Slot 3
		Port	3/1	3/2	3/3	3/4	3/5	3/6	3/7	3/8
		Tagged	<input type="checkbox"/>	<input type="checkbox"/>	<input type="checkbox"/>	<input type="checkbox"/>	<input type="checkbox"/>	<input type="checkbox"/>	<input type="checkbox"/>	<input type="checkbox"/>
		Untagged	<input checked="" type="checkbox"/>	<input checked="" type="checkbox"/>	<input checked="" type="checkbox"/>	<input checked="" type="checkbox"/>	<input checked="" type="checkbox"/>	<input checked="" type="checkbox"/>	<input checked="" type="checkbox"/>	<input checked="" type="checkbox"/>

On **VLAN Edit** page you can change the settings for the VLAN as described below:

VID	The VLAN's unique identifier. You cannot change the VID of an already created VLAN.
Enabled	Used to enable or disable a VLAN. Ports on a disabled VLAN are temporarily moved to the system default VLAN. To enable the VLAN - check the box, to disable un-check the box.
Name	The name of the VLAN. You cannot change the VLAN name using the web tool.
Continued on next page	

Continued from previous page	
Prio	VLAN priority setting. Values between 0-7 or disabled. See also section 15.1.4 . Select the desired VLAN priority in the drop down list, or select disable to disable VLAN priority.
IGMP	To enable IGMP snooping on this VLAN - check the box, to disable IGMP un-check the box. See section 15.1.5 for more information.
Port	<p>The ports on your switch is grouped as on the actual hardware, in slots. To assign a port to the VLAN, check the Tagged or Untagged check-box located underneath the port label. In the picture above you see all ports but 2/3 associated <i>untagged</i> to VLAN 1.</p> <p>A port may not be associated tagged and untagged to the same VLAN at the same time. It may not be associated untagged to more than one VLAN at a time. If you associate a port untagged to a VLAN any existing untagged association to another VLAN on that port will automatically be removed. You will be notified if this happens. For more information on the <i>tagged</i> and <i>untagged</i> association modes, see section 15.1.1.</p> <p>The Forbidden check-box is used to specify that this port can not be dynamically assigned to this VLAN (see section 15.1.7 for more information on dynamic VLANs).</p>

15.3.2 Create a new VLAN using the web interface

Menu path: Configuration ⇒ VLAN ⇒ VLANs ⇒ **New VLAN**

When clicking the **New VLAN** button you will be presented to the **new VLAN** page.

New VLAN

VID	<input type="text" value="2"/>
Enabled	<input checked="" type="checkbox"/>
Name	vlan2
Priority	<input type="text" value="Disabled"/>
IGMP	<input checked="" type="checkbox"/>

		Slot 1	
Port		1/1	1/2
Tagged		<input type="checkbox"/>	<input type="checkbox"/>
Untagged		<input type="checkbox"/>	<input type="checkbox"/>

		Slot 2			
Port		2/1	2/2	2/3	2/4
Tagged		<input checked="" type="checkbox"/>	<input type="checkbox"/>	<input type="checkbox"/>	<input type="checkbox"/>
Untagged		<input type="checkbox"/>	<input type="checkbox"/>	<input checked="" type="checkbox"/>	<input type="checkbox"/>

		Slot 3							
Port		3/1	3/2	3/3	3/4	3/5	3/6	3/7	3/8
Tagged		<input type="checkbox"/>	<input type="checkbox"/>	<input type="checkbox"/>	<input type="checkbox"/>	<input type="checkbox"/>	<input type="checkbox"/>	<input type="checkbox"/>	<input type="checkbox"/>
Untagged		<input type="checkbox"/>	<input type="checkbox"/>	<input type="checkbox"/>	<input type="checkbox"/>	<input type="checkbox"/>	<input type="checkbox"/>	<input type="checkbox"/>	<input type="checkbox"/>

The **New VLAN** and the **Edit VLAN** pages differ only by the possibility to change the VID (VLAN ID). See [section 15.3.1](#) for additional attribute descriptions.

VID	The VLAN's unique identifier.
Name	The VLAN name will be automatically generated when using the web management tool. The name is shown directly when you change and leave the VID field if your browser is JavaScript enabled, otherwise it will be generated when you click the Apply button.

15.3.3 Managing Dynamic VLAN using the web interface

This enables WeOS Adaptive VLAN Trunking (AVT) on the switch. For more information on AVT in [section 15.1.7](#).

Menu path: Configuration ⇒ VLAN ⇒ Dynamic

VLANS

Dynamic	<input checked="" type="radio"/> Disabled	<input type="radio"/> Adaptive
----------------	---	--------------------------------

Apply



Cancel

15.3.4 Managing port-based network access control using the web interface

Menu path: Configuration ⇒ VLAN ⇒ Port Access

The VLAN Port Access page shows an overview of the currently configured VLANs with the port-based network access control settings.

Port Access

VID	Name	802.1X	MAC auth	Excluded Ports	
1	vlan1	—	MAC list 1	eth 3	
2	vlan2	setup 1	—	none	
3	vlan3	—	—	none	

VID	The VLAN's unique identifier.
Name	The name of the VLAN.
802.1X	The description of the referenced 802.1X configuration, a dash means it is disabled. See section 9.2.17 for configuration of 802.1X.
MAC auth	The description of the referenced MAC authentication configuration, a dash means it is disabled. See section 9.2.20 for configuration of MAC authentication
Excluded Ports	List of ports on this VLAN that are excluded from port access control.
 Edit	Click this icon to edit the port access configuration for this VLAN.

15.3.5 Edit port-based network access control settings

Menu path: Configuration ⇒ VLAN ⇒ Port Access ⇒ 

When clicking the *Edit* icon for a VLAN you will be presented to the VLAN Port Access edit page.

Edit Port Access

VID	1
Name	vlan1

Authentication

802.1x settings	Disabled
MAC Auth settings	(0) MAC list 1

Excluded Ports

Port	1	2	3	4	5	6
Excluded	<input type="checkbox"/>	<input type="checkbox"/>	<input checked="" type="checkbox"/>	<input type="checkbox"/>	<input type="checkbox"/>	<input type="checkbox"/>

VID	The VLAN's unique identifier.
Name	The name of the VLAN.
802.1X settings	Enable IEEE 802.1X authentication for ports on this VLAN by selecting a 802.1X configuration. See section 9.2.17 for how to create and edit the 802.1X configurations.
Continued on next page	

Continued from previous page	
MAC Auth settings	Enable MAC based authentication by selecting a configuration. See section 9.2.20 for managing MAC authentication configurations.
Excluded Ports	The ports on your switch is grouped as on the actual hardware, in slots. Check the box underneath the port label to exclude that port from access control. An excluded port will be open and does not require authentication. This is suited for uplink ports, trunk ports and for connecting servers. The default for ports is unchecked, thus enabling port access control/authentication. Check-boxes can be shown as disabled, like port 1 and 2 in the above picture. This means that the current VLAN does not have this port as a member and is therefore not relevant for exclusion. See section 15.3.1 for managing the relations between ports and VLANs.

15.3.6 Port-based network access control statistics

Menu path: Status ⇒ Port Access

Here you can see an overview over port access status on a per-port basis. The 802.1X column shows if IEEE 802.1X is enabled for a port or not. The MAC auth column shows if MAC based authentication is enabled.

You can also see the current number of authenticated hosts. This value is only showing hosts that have authenticated recently. There may be more hosts on the network that can be authenticated via MAC based authentication but are inactive on the network for the moment. See [section 15.2.2](#) for information about inactivity and MAC based authentication.

Port Access Status

Port	802.1X	MAC auth	Nr of authenticated connections	Details
4	—	✓	0	
5	—	✓	0	
6	—	✓	0	
7	—	✓	0	
8	—	✓	0	
9	—	✓	0	
10	—	✓	1	

Auto-Refresh: Off, 5s, 15s, 30s, 60s

Refresh

A detailed view of the authenticated hosts is shown if you click on the magnifier icon for a port. This view shows all authenticated host by their MAC address. This list shows hosts that are authenticated with both IEEE 802.1X and MAC based authenticated together.

Port Access Details - Port 10

Authorized MAC
00:80:c8:3c:25:b7

15.4 Managing VLAN settings via the CLI

Command	Default	Section
<u>MAC Forwarding Database Configuration</u>		
fdb		Section 15.4.1
[no] aging-timeout <0 1-3825>	300	Section 15.4.2
[no] mac <MACADDR> port <PORTLIST>		Section 15.4.3
[no] profinet	Enabled	Section 15.4.4
<u>General VLAN Configuration</u>		
[no] vlans		Section 15.4.5
[no] dynamic <adaptive>	Disabled	Section 15.4.6
<u>Per VLAN Configuration</u>		
[no] vlan <VID>		Section 15.4.7
[no] enable	Enabled	Section 15.4.8
name <VLANNNAME>	vlan<VID>	Section 15.4.9
[no] untagged <PORTLIST>		Section 15.4.10
[no] tagged <PORTLIST>		Section 15.4.11
[no] forbid <PORTLIST>		Section 15.4.12
[no] fdb <0..63>	0	Section 15.4.13
[no] priority <0-7>	Disabled	Section 15.4.14
[no] igmp	Enabled	Section 15.4.15
channel <CHANNELID>	0	Section 15.4.16
[no] dot1q	Enabled	Section 15.4.17
[no] dot1x-auth <ID>	Disabled	Section 15.4.18
[no] mac-auth <ID>	Disabled	Section 15.4.19
[no] except-auth <PORTLIST>	Disabled	Section 15.4.20
<u>Show VLAN Status and MAC Forwarding Database Status</u>		
show vlans		Section 15.4.21
show fdb [id] [full]		Section 15.4.22
<u>Show Port-based Network Access Control Status</u>		
show dot1x-auth		Section 15.4.23
show mac-auth		Section 15.4.24

15.4.1 Managing MAC Forwarding Database Settings

Syntax fdb

Context [Global Configuration](#) context

Usage Use the **"fdb"** command to enter the MAC Forwarding Database context (*fdb*).

Use **"show fdb"** to show current FDB settings (list of configured MAC address filters, and the configured aging timeout). Also available as **"show"** command within the MAC Forwarding Database.

Default values Not applicable.

15.4.2 Configure MAC Address Aging Timeout

Syntax [no] aging-timeout <0|1-3825>

Context [MAC Forwarding Database](#) context (*fdb*)

Usage Set the aging timeout (in seconds) for unicast MAC addresses learnt dynamically. The configured aging timeout will only be an approximation of the actual aging timeout. The value is first rounded upwards in steps of 15 seconds. The MAC entries will be purged from the forwarding database within 1/7th of the resulting aging timeout.

Use **"no aging-timeout"** or **"aging-timeout 0"** to disable aging entirely.

Use **"show aging-timeout"** to view the current setting.

Default values 300 (seconds)

15.4.3 Configure Static MAC Filter Entries

Syntax [no] mac <MACADDRESS> port <[PORTS] [ALL] [CPU] | [NONE]>

Context [MAC Forwarding Database](#) context (*fdb*)

Usage Add or delete a static MAC address filter. The **"MACADDRESS"** is written as a colon separated hexadecimal value, e.g., **"01:23:45:56:89:AB"**.

The **"PORTLIST"** states the port(s) where packets with the given (destination) MAC address are to be forwarded. As of WeOS v4.33.0, the static MAC

filters are only intended to be used for multicast MAC addresses (not unicast MAC or the broadcast MAC addresses).

The **"PORTLIST"** can include both visible ports (e.g., **"eth 2/1-2/4"** on a slotted WeOS unit) as well as the internal CPU port(s):

- PORT(S): Port, set of or range of ports, e.g. eth 1,3-5
- ALL: All visible ports, excluding internal CPU port(s)
- NONE: No ports, filter this MAC address
- CPU: The internal CPU port(s)

Use **"no MAC <MACADDRESS>"** to remove a specific static MAC filter, or **"no MAC"** to remove all static MAC filters.

Use **"show mac"** to list configured MAC address entries.

Default values (The factory default configuration includes a set of static MAC filters.)

15.4.4 Configure PROFINET Pass-Through

Syntax [no] profinet

Usage Enable or disable pass-through of PROFINET signalling traffic. Use command **"profinet"** to enable PROFINET pass-through. This will create static MAC filters for addresses in range *01:0e:cf:00:0X:XX*, thereby allowing PROFINET signalling to pass-through even when IGMP snooping is enabled.

To see exactly which MAC addresses filters are created for, use the **"show fdb full"** command ([section 15.4.22](#)) in the [Admin Exec](#) context.

Use **"no profinet"** to disable PROFINET pass-through.

Use **"show profinet"** to show the current setting.

Default values Enabled

15.4.5 Managing general VLAN settings

Syntax [no] vlans

Context [Global Configuration](#) context

Usage Enter the General VLAN Configuration context (*vlangs*). The General VLAN Configuration context can be used to configure VLAN settings applicable to all VLANs.

Use **"no vlangs"** to remove all VLANs except the switch default VLAN (VLAN 1). All ports will be configured *untagged* on VLAN 1.

Use **"show vlangs"** to list all configured VLANs and general VLAN settings.

Default values Not applicable.

15.4.6 Enable dynamic VLAN

Syntax [no] dynamic <adaptive>

Context [General VLAN Configuration](#) context (*vlangs*)

Usage Use the **"dynamic adaptive"** command to enable WeOS Adaptive VLAN Trunking (AVT) on the switch. For more information on AVT in [section 15.1.7](#).

Future versions of WeOS may include support for dynamic VLAN via GVRP in addition to AVT, but currently only AVT is supported.

Use **"no dynamic"** to disable dynamic VLAN support.

Use **"show dynamic"** to see the dynamic VLAN setting.

Default values Disabled

15.4.7 Managing individual VLANs

Syntax [no] vlan <VID>

Context [Global Configuration](#) context

Usage Enter VLAN Configuration context of the given VID. If this is a new VLAN, the VLAN will be created first upon leaving the VLAN context with *end* or *leave*.

Use **"no vlan <VID>"** to remove an existing VLAN. The default VLAN (VLAN 1) cannot be removed. Removal of a VLAN may imply that some ports will no longer be associated with any VLAN - such ports will be configured to the default VLAN (VLAN 1) untagged.

Use **"show vlan"** (or **"show vlangs"**) to list all configured VLANs and general VLAN settings. Use **"show vlan VID"** to list detailed configuration informa-

tion for a specific VLAN (also available as **"show"** command within the VLAN Configuration context of the given VID.

Default values Not applicable.

Example

```
example:/config/#> show vlan 1
VLAN ID       : 1
Status        : Enabled
Name          : vlan1
Channel       : 0
Priority       : Disabled
Untagged      : U:eth 1-4
Tagged        : T:
Forbid        : F:
IGMP          : Enabled
Learning      : Enabled
802.1Q VLAN   : Enabled
802.1X Auth   : Disabled
MAC Auth      : Disabled
Except Port Auth :
example:/config/#>
```

15.4.8 Enable/disable a VLAN

Syntax [no] enable

Context [VLAN Configuration](#) context

Usage Enable or disable a VLAN. A disabled VLAN is similar to a deleted VLAN, except that its configuration is stored, and will be activated when the VLAN is *enabled*. That is, when a VLAN is disabled, its ports may be moved onto the default VLAN (unless they are associated with another VLAN), and any network interface associated with the VLAN will be disabled.

Use **"show enable"** to view the current configuration.

Default values *enable*

15.4.9 VLAN name

Syntax name <ID>

Context [VLAN Configuration](#) context

Usage Specify VLAN name, i.e., VLAN description. Max 15 characters, only alpha-numerical characters ([a-z,A-Z,0-9]) allowed.

Use "**show name**" to view the VLAN name setting.

Default values If no VLAN "**name**" command is given, the VLAN name defaults to *vlanVID*, e.g., *vlan100* for VID 100.

15.4.10 Manage untagged ports

Syntax [no] untagged <PORT|PORTLIST>

Context [VLAN Configuration](#) context

Usage Associate port(s) with this VLAN VID in *untagged* mode. Only a single VLAN VID can be associated *untagged* with each port. Ports associated with a VLAN VID *untagged* will have that VID as *default VID* - this will have precedence over any (fall-back) default VID configuration set in *port* context.

Use "**no untagged <PORTLIST>**" to remove *untagged* ports from a VLAN. If removal of an *untagged* port implies that the port is no longer associated with any VLAN, that port will be configured to VLAN 1 *untagged*.

Use "**show untagged**" to view ports associated untagged with this VLAN.

Default values Factory default lets all ports be associated with the default VLAN (VLAN 1) *untagged*. For new VLANs, ports must explicitly be added.

Error messages

- A notification message is given in case the addition of port as *untagged* on one VLAN implies that the same port will be removed as *untagged* on another VLAN.

- A notification message is given in case the addition of port as *untagged* on one VLAN implies that the same port will be removed as *tagged* on the same VLAN (a port cannot be associated both *tagged* and *untagged* with the same VLAN).

A "**PORTLIST**" is a comma separated list of port ranges without intermediate spaces, e.g., "**1/1-1/3,2/3**".

15.4.11 Manage tagged ports

Syntax [no] tagged <PORT|PORTLIST>

Context [VLAN Configuration](#) context

Usage Associate port(s) with this VLAN VID in *tagged* mode.

Use **"no tagged <PORTLIST>"** to remove *tagged* ports from a VLAN. If removal of a *tagged* port implies that the port is no longer associated with any VLAN, that port will be configured to VLAN 1 *untagged*.

Use **"show tagged"** to view ports associated tagged with this VLAN.

Default values Not applicable.

Error messages A notification message is given in case the addition of port as tagged on one VLAN implies that the same port will be removed as *untagged* on the same VLAN (a port cannot be associated both *tagged* and *untagged* with the same VLAN).

A **"PORTLIST"** is a comma separated list of port ranges without intermediate spaces, e.g., **"1/1-1/3,2/3"**.

15.4.12 Manage forbidden ports

Syntax [no] forbid <PORT|PORTLIST>

Context [VLAN Configuration](#) context

Usage Prohibit that ports are dynamically added (AVT) to this VLAN ID, see also [sections 15.1.7](#) and [15.4.6](#).

Use **"no forbid <PORTLIST>"** to remove ports from the list of ports forbidden to be associated with this VLAN.

Use **"show forbidden"** to view ports associated forbidden with this VLAN.

Default values Not applicable.

A **"PORTLIST"** is a comma separated list of port ranges without intermediate spaces, e.g., **"1/1-1/3,2/3"**.

15.4.13 Manage forwarding database

Syntax [no] fdb <0..63>

Context [VLAN Configuration](#) context

Usage By default the FDB is shared between all VLANs.

Use **"no fdb"** or **"fdb 0"** for the default behaviour and **"fdb <1..63>"** to use a specific FDB for this VLAN.

 **Note**

Please note that using a specific FDB does not work together with link aggregation or together with RSTP.

15.4.14 VLAN priority setting

Syntax [no] priority <0-7>

Context [VLAN Configuration](#) context.

Usage Set the (IEEE 802.1p) priority associated with this VLAN. Incoming packets associated with this VLAN will receive this priority.

"no priority" will disable VLAN priority for this VLAN. Priority for packets associated with this VLAN will then be based on port priority settings.

Use "show priority" to view the priority setting for this VLAN.

Default values Disabled ("no priority").

15.4.15 VLAN IGMP Snooping

Syntax [no] igmp

Context [VLAN Configuration](#) context.

Usage Enable, or disable IGMP Snooping for this VLAN.

Use "show igmp" to view the IGMP snooping setting for this VLAN.

Default values IGMP snooping enabled.

15.4.16 CPU channel mapping

Syntax channel <CHANNELID>

Context [VLAN Configuration](#) context.

Usage Specify CPU channel to use for this VLAN. The channel identifier can take values in the range <0-CHANNELIDMAX>. The purpose of this command is to improve routing performance by mapping VLANs to different CPU channels, see [section 15.1.6](#).

**Hint**

Use the **"show system-information"** command (see [section 7.3.2](#)) to find out the number of channels.

- Look for the line "Channel interfaces" in the information of the CPU card to see the number of channels.
- CHANNELIDMAX equals "number of channels"-1.

Use **"show channel"** to view the CPU channel setting for this VLAN.

Default values 0 (zero), i.e., by default all VLANs will use channel 0.

15.4.17 802.1Q VLAN Filtering

Syntax [no] dot1q

Context [VLAN Configuration](#) context

Usage Configuration of IEEE 802.1Q VLAN filtering for this VLAN.

Disabling IEEE 802.1Q VLAN filtering for a VLAN means ingress traffic on untagged port for this VLAN will be assigned the default VLAN ID for the port. This can be used to set up Q-in-Q VLAN tunneling. Note that this setting can also be set on a per port basis, see [section 10.3.17](#).

Use **"show dot1q"** to show the current setting.

Default values Enabled.

15.4.18 IEEE 802.1X authentication

Syntax [no] dot1x-auth <ID>

Context [VLAN Configuration](#) context.

Usage Specify the IEEE 802.1X configuration to be used for this VLAN. Setting this enables port-based network access control for all ports untagged in this VLAN, except for the ports defined with **"except-auth"** (see [section 15.4.20](#)). The ID value references the 802.1X configuration. This configuration is managed in the AAA subsystem, see [chapter 9](#). Use **"no dot1x-auth"** to disable IEEE 802.1X authentication for this VLAN.

Use **"show dot1x-auth"** to view the IEEE 802.1X authentication setting for this VLAN.

Default values Disabled, i.e. IEEE 802.1X is not used.

15.4.19 MAC based authentication

Syntax [no] mac-auth <ID>

Context [VLAN Configuration](#) context.

Usage Specify the MAC authentication configuration to be used for this VLAN. Setting this enables port-based network access control for all ports untagged in this VLAN, except for the ports defined with **"except-auth"** (see [section 15.4.20](#)). The ID value references the MAC authentication configuration. This configuration is managed in the AAA subsystem, see [chapter 9](#). Use **"no mac-auth"** to disable MAC based authentication for this VLAN.

Use **"show mac-auth"** to view the MAC based authentication setting for this VLAN.

Default values Disabled, i.e. MAC based authentication is not used.

15.4.20 Except ports from authentication

Syntax [no] except-auth <PORT|PORTLIST>

Context [VLAN Configuration](#) context.

Usage Disables port-based network access controls for specific ports. This is used together with **"dot1x-auth"** and **"mac-auth"** to exclude specific ports from needing authentication. This is suitable for uplinks, trunks and ports with servers connected. Use **"no except-auth"** to remove all port exceptions, thus *enabling* access control on all untagged ports in this VLAN.

Use **"show mac-auth"** to view ports configured to be excluded from port-based network access control for this VLAN.

Default values Disabled, no ports excluded.

15.4.21 Show VLAN status (all VLANs)

Syntax show vlans

Context [Admin Exec](#) context

Usage Show VLAN status information for all VLANs.

Default values Not applicable.

15.4.22 Show Current MAC Forwarding Database

Syntax show fdb [id] [full]

Context Admin Exec context

Usage Show the current state of the MAC forwarding database. This includes the list of MAC addresses known to the switch, and the port(s) to forward packets to each MAC address. The ageing timeout for automatically learned unicast MAC addresses is shown at the bottom.

The **"id"** argument can be used to show a specific FDB is shown. By default the shared VLAN FDB, id 0, is shown.

The optional **"full"** argument can be used to list more detailed information about the entries in the MAC forwarding database.

Default values Not applicable.

 **Example**

```
example:/#> show fdb
```

MAC	VLAN	State	Port(s)
00:07:7c:81:de:1a	ANY	252 s	CPU
00:80:c8:3c:a7:ff	ANY	294 s	4
01:00:5e:00:00:01	ANY	Static	1-6,CPU
01:00:5e:00:00:02	ANY	Static	1-6,CPU
01:00:5e:00:00:04	ANY	Static	1-6,CPU
01:00:5e:00:00:05	ANY	OSPF	1-6,CPU
01:00:5e:00:00:06	ANY	OSPF	1-6,CPU
01:00:5e:00:00:09	ANY	RIPv2	1-6,CPU
01:00:5e:00:00:0a	ANY	Static	1-6,CPU
01:00:5e:00:00:0d	ANY	PIMv2	1-6,CPU
01:00:5e:00:00:0e	ANY	Static	1-6,CPU
01:00:5e:00:00:12	ANY	VRRP	1-6,CPU
01:00:5e:00:00:18	ANY	Static	1-6,CPU
01:00:5e:00:00:66	ANY	Static	1-6,CPU
01:00:5e:00:00:6a	ANY	Static	1-6,CPU
01:00:5e:00:00:6b	ANY	Static	1-6,CPU
01:00:5e:00:00:fb	ANY	mDNS	1-6,CPU
01:0e:cf:00:0x:xx	ANY	PROFINET	ALL
01:80:c2:00:00:00	ANY	Mgmt	1-6,CPU
01:80:c2:00:00:02	ANY	Mgmt	1-6,CPU
01:80:c2:00:00:03	ANY	Mgmt	1-6,CPU
01:80:c2:00:00:0e	ANY	LLDP	CPU
01:80:c2:00:00:10	ANY	Mgmt	1-6,CPU

```

=====
PROFINET: Enabled, MAC 01:0e:cf:00:00 .. 01:0e:cf:00:05:00
FDB Aging time: 300 sec.
example:/#>

```

In the example above, PROFINET pass-through has been enabled ([section 15.4.4](#)). To see exactly which MAC addresses in the `01:0e:cf:00:0x:xx` that have entries, use `"show fdb full"`.

15.4.23 Show IEEE 802.1X authentication status

Syntax `show dot1x-auth`

Context [Admin](#) [Exec](#) context

Usage Show hosts that are currently authenticated with IEEE 802.1X.

Default values Not applicable.

15.4.24 Show MAC based authentication status

Syntax `show mac-auth`

Context [Admin](#) [Exec](#) context

Usage Show hosts that are currently authenticated with MAC based access control.

 **Note**

There may be hosts on the network that matches the MAC authentication filters, but are inactive for the moment. Inactive hosts are flushed out of this list and will be re-authenticated again on resumed activity. See [section 15.2.2](#) for details.

Default values Not applicable.

Chapter 16

FRNT

The Fast Reconfiguration of Network Topology (FRNT) protocol handles fast re-configuration in switched ring and sub-ring topologies. When rapid convergence in case of link or switch failure is required, FRNT becomes the protocol of choice when it comes to layer-2 resilience and robustness.

Two versions of FRNT exist, version 0 and 2. FRNTv0 supports one ring instance and FRNTv2 can support multiple ring and sub-ring instances. FRNTv2 is not backwards compatible with version 0, thus an FRNTv2 instance can *not* act as *focal point* or *member* in an FRNTv0 ring. However, it is possible to run both FRNTv0 and FRNTv2 on the same switch; in this case one need to ensure that there are no (layer-2) loops spanning across the different rings.

In addition to FRNT, WeOS supports RSTP ([chapter 18](#)) and MRP ([chapter 19](#)) as alternative layer-2 redundancy protocols. This chapter describes some of the restrictions of mixing FRNT, RSTP and MRP on the same switch.

16.1 Overview of the FRNT protocol and its features

The table below summarises FRNT features available via the Web and CLI interfaces. A general description of the FRNT protocol and its features is presented in [sections 16.1.1](#) and [16.2](#). If you are only interested in knowing how to manage the FRNT features via the Web or CLI, please visit [sections 16.3](#) or [16.4](#) directly.

Feature	Web	CLI	General Description
Enable FRNT	X	X	Section 16.1.1
Set FRNT mode (focal-point or member switch)	X	X	-"-
Set FRNT ring ports	X	X	-"-
View FRNT Status	X	X	-"-
FRNT subrings	X	X	Section 16.1.2
FRNT Port configuration	X	X	Section 16.1.3
Guidelines when selecting FRNT ports			Section 16.1.4
VLANs used by FRNT			Section 16.1.5
FRNT, RSTP and MRP coexistence			Section 16.2

16.1.1 FRNTv0 and FRNTv2 introduction

The overall functionality of FRNTv0 and FRNTv2 is the same when configured in a ring topology. The FRNT protocol handles fast reconfiguration in switched ring topologies. One of the switches has the role of FRNT *focal point* while the other switches are referred to as FRNT *members*. When the switches are connected in a ring, it is the responsibility of the focal point to break the loop by putting one of its ports in *blocking* mode, see [fig. 16.1](#).

Note
In an FRNT ring or a sub-ring, only one of the switches can be configured as focal point. The other switches should be configured as member switches (i.e., non-"focal-point").

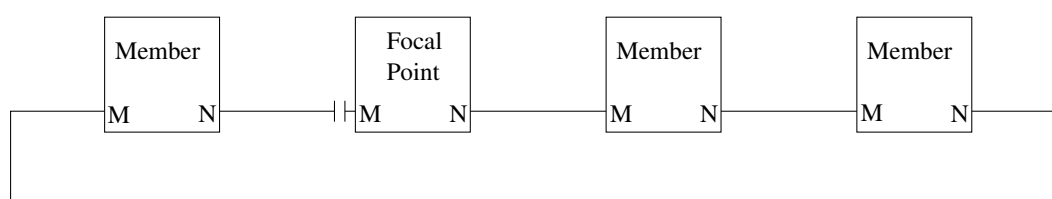

Figure 16.1: FRNT network operating in *ring mode*. One port on Focal Point is in BLOCKING state.

Once a link failure is detected somewhere along the ring, the focal point will put its blocked port in *forwarding* mode to establish full connectivity between the switches (see [fig. 16.2](#)). FRNT is *event based*: switches detecting a *link down*

event will immediately send a *link down* FRNT message towards the focal point. Intermediate switches will forward the FRNT messages with highest priority, and the focal point will open its **BLOCKED** port upon receiving the *link down* message.

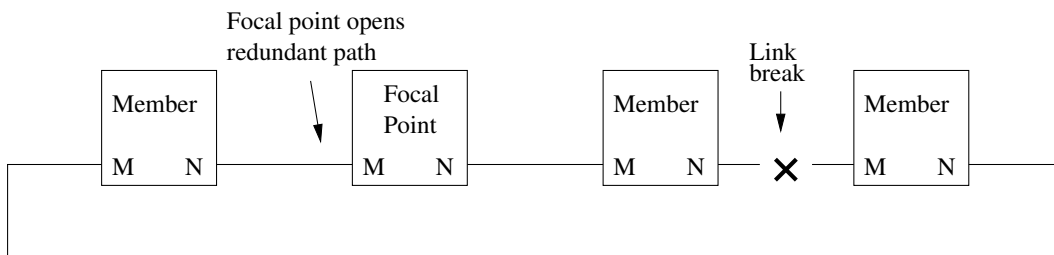

Figure 16.2: FRNT network operating in *bus mode* due to broken link.

Similarly, when a broken link comes back up again and the ring is fully connected, the focal point will react and put its back to blocking state.

Below is a configuration example for an FRNTv0 member.

```

Example
example:/#> configure
example:/config/#> frnt 1
example:/config/frnt-1/#> ring-ports 1,2
example:/config/frnt-1/#> no focal-point
example:/config/frnt-1/#> leave
example:/#> show frnt

```

Rid	Ver	Status	Top Cnt	Mode	Port 1	Port 2
1	0	OK	0	Member	Eth 1 Up	Eth 2 Up

```

example:/#>

```

It is possible to configure up to 10 FRNT instances on the same switch. Of these, there can be at most one FRNTv0 instance and at most 10 FRNTv2 instances.

Consider the case where you have one FRNTv0 ring, and wish to add a second FRNT ring. As there can be at most one FRNTv0 instance per switch, the second ring (or sub-ring) must run FRNTv2. The example below shows how to configure the switch on a second FRNT(v2) ring. On this ring, the switch acts as FRNT focal point.

 **Example**

```
example:/config/#> frnt 10
example:/config/frnt-10/#> version 2
example:/config/frnt-10/#> port 3
example:/config/frnt-10/port-Eth3/#> end
example:/config/frnt-10/#> port 4
example:/config/frnt-10/port-Eth4/#> leave
example:/#> show frnt
```

Rid	Ver	Status	Top Cnt	Mode	Port 1	Port 2
1	0	OK	0	Member	Eth 1 Up	Eth 2 Up
10	2	OK	2	Focal	Eth 3 Up	Eth 4 Up

```
example:/#>
```

16.1.2 Creating sub-rings (horse-shoes) with FRNT

The following sections describes how to create sub-rings (horse-shoes) with FRNT.

- FRNTv2 provides native support for creating sub-rings. This is the recommended way, and is covered in [section 16.1.2.1](#).
- With FRNTv0, sub-rings can be created by running FRNTv0 in *bus mode*, and to use this in combination with FRNT Ring Coupling ([chapter 17](#)). This method is covered in [section 16.1.2.2](#).

16.1.2.1 FRNTv2 sub-rings

FRNTv2 supports sub-ring topologies. Sub-rings can be thought of as a partial ring in the shape of a “C” that is not fully closed (a “horse-shoe”). Sub-rings can be hooked into a regular FRNTv0 or FRNTv2 *super-ring* and to other FRNTv2 sub-rings as well. This allows for complex ring topologies to be built as shown in [fig. 16.3](#).

The switches in each end of the sub-ring will have only one FRNT ring port configured and one of those switches needs to be the focal point. The member switches between the sub-ring end switches are configured as a member switch with two port as in a super-ring. When the sub-ring is *intact* the focal point will block its sub-ring port to prevent a loop. If a link break is detected in the sub-ring the focal point will open its blocked ring port to restore connectivity in the network.

Below is a configuration example for a member FRNTv2 sub-ring *end switch*, i.e.,

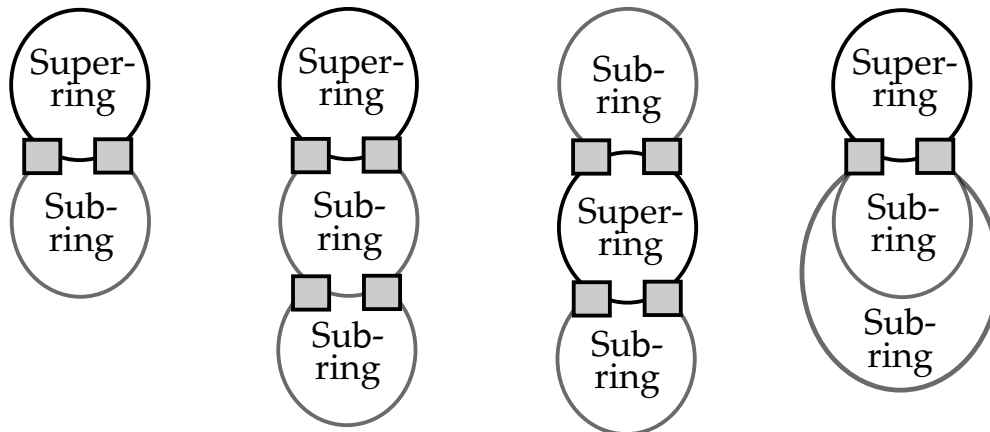

Figure 16.3: Example of sub-ring topologies.

only a single FRNT port is configured (here port 4). It assumes there is already an FRNT super-ring configured (here an FRNTv0 ring with ring-ports 1 and 2).

Example

```
example:/#> configure
example:/config/#> frnt 10
example:/config/frnt-10/#> version 2
example:/config/frnt-10/#> port 4
example:/config/frnt-10/port-Eth4/#> end
example:/config/frnt-10/#> no focal-point
example:/config/frnt-10/#> leave
example:/#> show frnt
```

Rid	Ver	Status	Top Cnt	Mode	Port 1	Port 2
1	0	OK	0	Member	Eth 1 Forwarding	Eth 2 Forwarding
10	2	OK	3	Member	Eth 4 Forwarding	

```
example:/#>
```

16.1.2.2 FRNTv0 Sub-rings

It is possible to use FRNTv0 in sub-ring (horse-shoe) topologies, by using it in combination with FRNT Ring Coupling ([chapter 17](#)), and hook the horseshoe into an FRNT *super-ring*. When setting up an *FRNTv0 bus*, you will lose the redundancy properties as compared to running a regular FRNT ring. The redundancy is then provided by the Ring Coupling uplinks.

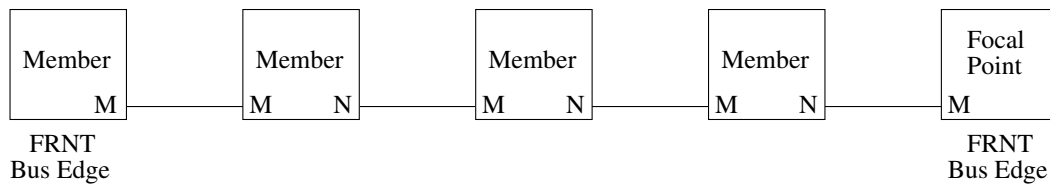

Figure 16.4: Configuring FRNTv0 in bus topology. Edge nodes have only one FRNT port. One of the bus edges must be configured as focal point.

The rest of this section explains how to setup FRNTv0 in bus mode.

Note
The main use case for configuring an FRNTv0 bus is to achieve a horseshoe topology, by using the FRNTv0 bus together with Ring Coupling. See [section 17.1.1.3](#) for more information on the horseshoe use case.

In an FRNTv0 bus, two of the FRNT nodes will be configured as *FRNT bus edge nodes*, i.e., these nodes will only be configured with one FRNT port each.

- One of the bus edge nodes must be configured as FRNTv0 focal point, with only one FRNT port (port "M").
- The other bus edge node is configured as FRNTv0 member switch, with only one FRNT port (port "M").
- Intermediate FRNT nodes are configured as regular FRNTv0 members with two FRNT ports.

When running FRNTv0 as a bus, the focal point (located in one edge) will detect if the bus is *intact* or if it is *broken*. Thus, the FRNT status on the focal point will indicate the status of the configured bus, and you can determine the status of the FRNT bus (OK or Broken) by inspecting the FRNT status on the focal point. As opposed to when running FRNT as a ring, a focal point configured as bus edge will *not* put its FRNT port "M" in blocking mode when the topology is intact.

16.1.3 FRNT Port configuration and status

An FRNT link must be qualified before it can be used as a active link in an FRNT ring. In FRNTv0 the link qualification is done with with control traffic, i.e hello packets. In FRNTv2 there are two ways to qualify a link, with control traffic, i.e.

hello packets, or on physical link up event. Both FRNT switches on each side of the link must use the same qualification procedure.

When the link is qualified with hello packets the attached FRNT nodes verifies that there is two-way connectivity over the link. The primary reason for this is to ensure adequate operation of FRNT in both directions of a link, and specifically over a fiber optic link pair.

If hello packets are disabled on ring port, FRNTv2 setting, the port will become qualified on link up and no further tests of the link quality is not done.

FRNT Port Status in cli and web for FRNTv0 and FRNTv2 are summarised in [table 17.2](#).

Link state	Port State	Port status	
		FRNTv0	FRNTv2
Down	Down	Down	Down
Up	Blocking	Down	Not Qualified
Up	Blocking	Up	Qualified
Up	Forwarding	Up	Forwarding

Table 16.1: Port status for FRNTv0 and FRNTv2.

16.1.3.1 FRNTv0 Port status

Down: FRNT do not receive hello packets from its attached FRNT node.

Up: FRNT receives hello packets from its attached FRNT node. If the port is in forwarding state it is active in the ring and it is forwarding traffic.

16.1.3.2 FRNTv2 Port status

Down: Link down on port.

Not Qualified: The port has link up but do not get response on transmitted hello packets from the attached FRNT node.

Qualified: The port receives hello packets from its attached FRNT node. It is ready to be used in the ring if needed but is still blocked. Focal point will have one of its port in qualified state when the ring is *intact*.

Forwarding: An active port in the ring and it is forwarding traffic.

16.1.4 Guidelines when selecting FRNT ports

When enabling FRNT on a switch, you need to select one or two ports to use as FRNT ports. Below are some recommendations and rules when selecting and configuring the FRNT ports.

- *Fixed speed, full duplex:* When using Ethernet ports as FRNT ports, fixed speed (and full duplex) is recommended over *auto-negotiation* of speed and duplex mode on the FRNT ports. Use 100 Mbit/s speed rather than 10 Mbit/s speed for best performance.
- *Some fixed Gbit copper ports has bad fail-over performance:* For fixed Gbit copper ports, the fail-over performance may be significantly higher. The reason behind this relates to restrictions in the Gbit Ethernet standard with respect to link down behaviour, which in turn affect the link-down detection performance.

For some switchcores, work-arounds exist to achieve fast link-down detection performance for Gbit copper ports. For example, fixed Gbit copper ports of MV88E6352 switchcore have good FRNT performance, while fixed Gbit copper ports of MV88E6185 have bad FRNT performance. See *Detailed System Overview* page in the Web ([section 4.4.2](#)) or use the "**show system-information**" in the CLI ([section 7.3.2](#)) to find information about what switchcore(s) is used in your product.

- *Avoid using copper SFPs as FRNT ports:* When using Ethernet ports as FRNT ports, choose fixed Ethernet ports or fiber SFPs. Copper SFPs may be used as FRNT ports, but will generally imply non-negligible degradation of fail-over performance.
- *SHDSL ports as FRNT ports:* It is possible to use SHDSL ports as FRNT ports, but fail-over performance is degraded as compared to (fixed) Ethernet ports. FRNT will not work correctly on SHDSL links with speed below 64 kbit/s.

16.1.5 VLANs used by FRNT

FRNTv0 uses VLAN IDs 4020-4022 and 4032-4033 and FRNTv2 uses VLAN IDs 4021-4022 for its signalling. Thus, when FRNT is enabled on a switch, these VLANs are implicitly reserved and cannot be configured by the user.



Warning

Note on using intermediate active equipment For FRNT to operate properly, there should **not** be any "non-FRNT-enabled" switches (or other active equipment) in the FRNT ring. However, if two FRNT nodes are interconnected via a non-FRNT switch for **testing** purposes, that intermediate switch must be configured to let VLANs 4020-4022 and 4032-4033 through when FRNTv0 is used and 4021-4022 for FRNTv2.

16.2 FRNT, RSTP and MRP coexistence

With WeOS it is possible to run FRNT and RSTP ([chapter 18](#)) on the same switch, be it with some topology restrictions. Fig. 16.5 shows an example of such a configuration, where two of the switches in the FRNT ring (thick lines) are running RSTP on the "non-FRNT" ports.

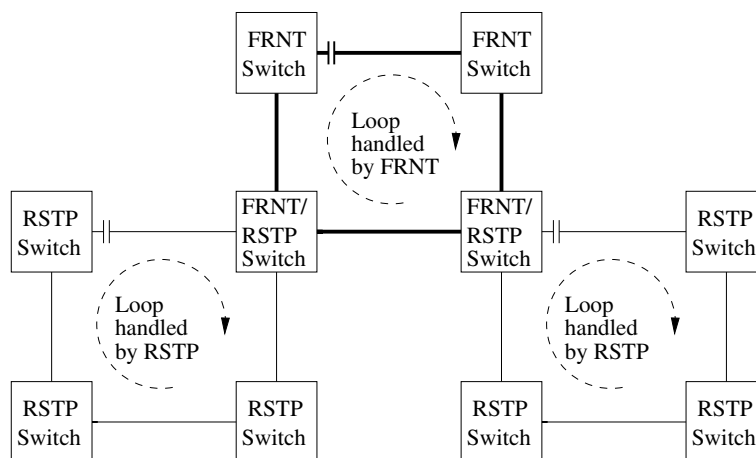

Figure 16.5: Example of coexistence of FRNT and RSTP.

As both RSTP and FRNT want to control a port's state (FORWARDING/BLOCKING), only one of the protocols may be activated on each port to avoid protocol conflicts. Therefore, if both FRNT and RSTP are configured to operate on a certain port, FRNT will have precedence to control the port's state.

Warning

FRNT and RSTP are each able to handle loops within their respective domains, however, if a physical loop is created including some links controlled by RSTP and others by FRNT, a broadcast storm is likely to occur, since neither RSTP nor FRNT is able to discover the loop, see fig. 16.6. Thus, if RSTP and FRNT is mixed in the same layer-2 network, the operator must ensure that loops across RSTP and FRNT links never occur.

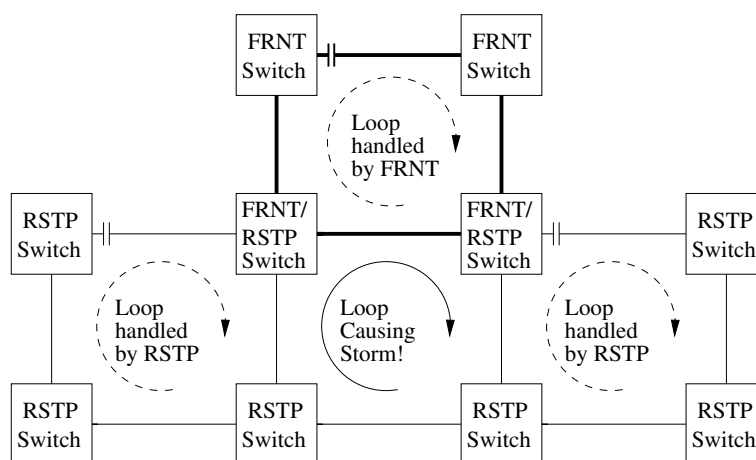

Figure 16.6: Example of loop spanning FRNT and RSTP links - a broadcast storm is likely to occur.

Similarly, it is possible to run FRNT and MRP (chapter 19) on different ports on the same switch as long as the operator can ensure that loops across FRNT and MRP links never occur if used in the same layer-2 network. The same restrictions apply to using MRP and RSTP on the same switch.

16.3 Managing FRNT settings via the web interface





It is possible to configure FRNT via the web interface. Notably, there are some differences in how FRNT version 0 and 2 can be configured via the web.

16.3.1 Managing FRNT settings

Menu path: Configuration ⇒ L2 Redundancy ⇒ FRNT

On the FRNT configuration page you will be presented with some of the current settings for FRNT on your switch, see below.

FRNT

Ring	Version	Focal Point	Ports	Couplings	
1	2	✓	1 3	—	 
2	0	✓	8 9	eth 7	 

Ring ID	A unique identifier for the FRNT ring.
Version	FRNT Version (version 0 or 2).
Focal Point	The focal point is the unit in the ring which is responsible for making decisions on topology change. A green check-mark indicates this unit will take the role as focal point in the FRNT ring. A dash indicates the unit will act as a <i>member</i> unit.
Ports	FRNT requires two ports to be assigned FRNT-ports. These are connected to peer units participating in the FRNT ring. The two ports connected to other units in the FRNT ring. Note: Ports with copper SFPs should not be used as FRNT ports, due to slow link down indication on copper SFPs. See section 16.1.4 for further guidelines on FRNT port selection.
Couplings	Lists the currently configured FRNT Ring-Couplings associated with this FRNT-ring, and the coupling uplink ports. Note: Couplings are only supported for FRNTv0.
 Edit	Click this icon to edit an FRNT instance.

Continued on next page

Continued from previous page



Delete

Click this icon to remove an FRNT instance.

If no FRNT instance is configured you may create one by clicking the **New** button. When editing a new or existing a new the page below is displayed.

New FRNT Ring

Version	0 ▾
Ring	1 (1-255)
Focal Point	<input checked="" type="checkbox"/>
Ring Port Settings	
Port M	1 ▾
Port N	7 ▾

Apply Cancel

For FRNTv2, there is a different page (see below), displayed by switching the version attribute. There are some additional settings, namely Forward Delay, Blocking Port and Hello Time. The settings for FRNTv0 and FRNTv2 are described in the table above.

New FRNT Ring

Version	2 ▾		
Ring	1	(1-255)	
Focal Point	<input checked="" type="checkbox"/>		
Guarded Recovery	<input checked="" type="checkbox"/>		
Ring Interval	500	(50-10000)	
Ring Port Settings			
	Ports	Hello Time	Blocking Port
	1 ▾	Enable <input checked="" type="checkbox"/> 500 (20-10000)	<input type="radio"/>
	7 ▾	Enable <input checked="" type="checkbox"/> 500 (20-10000)	<input checked="" type="radio"/>

Apply Cancel



In the case of FRNTv0, the lower part of the edit page displays a section, **Couplings**, where the FRNT Ring-Couplings, associated with this FRNTv0 instance is listed. This section will appear after clicking the **Apply** when a new FRNTv0 instance is created.

To create a new Coupling instance, click the **New Coupling** button (visible until MAX_RING_COUPLING_INSTANCES (section 17.4) has been reached). New and existing Ring-Couplings are edited on the page below:

Edit Coupling

Enabled	<input checked="" type="checkbox"/>				
Hello Time	100 ms				
Uplinks	Port	Priority	Adjustment	Echo Interval	Path-Cost
	Eth 1	180	0	200	Auto <input checked="" type="checkbox"/> <input type="text"/> <input type="button" value="🗑️"/>
	Eth 4	128	48	150	Auto <input type="checkbox"/> 4096 <input type="button" value="🗑️"/> <input type="button" value="⊕"/>

Apply Cancel

Enabled	A green checkbox if the coupling instance is enabled, a minus sign if not. On edit page, check/uncheck box to enable/disable coupling instance.
Hello Time	The interval between two hello messages in milliseconds.
Uplinks	
Port	The uplink port.
Priority	The uplinks priority. Used for calculating active uplink.
Adjustment	Priority adjustment delta for this uplink. Makes the uplink sticky by adjusting the effective priority with this value when uplink becomes active.
Echo Interval	The interval (ms) between packets sent to the uplink neighbour to verify uplink connectivity.
Path Cost	The uplinks path cost. Used for calculating active uplink. Auto (check-box checked) indicates path-cost is automatically calculated (based on link speed).
 Delete	Click this icon to remove a coupling instance.
 Add	Click this icon to add a new coupling instance.

16.3.2 FRNT Status and Statistics

Menu path: Status ⇒ L2 Redundancy ⇒ FRNT

On this page FRNT status and statistics are presented.

FRNT Status and Statistics

Ring	Version	Enabled	Mode	Status	Ports	Topology Change Count	Time Since Last Change
1	0	✓	Focal Point	OK	4 UP BLOCKING	5 UP FORWARDING	0 Days 1 Hours 13 Mins 7 Secs
2	2	✓	Focal Point	BROKEN	1 DOWN Down	2 DOWN Down	0 Days 0 Hours 2 Mins 34 Secs

Ring Coupling

Instance 1

	Port	Active	MAC	Effective Priority	Path-Cost	Speed/Duplex	Hello Time (ms)		Synchronized	Link Changes
							Effective	Configured		
Local	eth 3	✓	00:07:7c:27:37:c0	128	12500	100 Full	100	100	✓	4

Auto-Refresh: Off, [5s](#), [15s](#), [30s](#), [60s](#)

Figure 16.7: FRNT status and statistics in web

FRNT Status and Statistics	
Ring RID	A unique identifier for the FRNT-ring.
Version	The version of the FRNT-ring.
Enabled	Indication if the ring is enabled or not.
Mode	Focal point or member.
Status	Ring status, OK or BROKEN.
Ports	Operating status of ring ports.
Topology Change Count	Number of FRNT topology changes.
Time Since Last Change	Time since last FRNT topology change.

Continued on next page

Continued from previous page

Ring Coupling	
Local/Global	Local - uplinks located on this switch. Global - uplinks reported from other switches in the FRNT ring.
Port	The uplink port name, if any available on the distributing unit. Otherwise an information message stating that no uplinks are available.
Active	A green check-mark indicates this is the active uplink for the ring coupling instance.
MAC	The MAC address of the unit distributing this piece of uplink information.
Effective Priority	The actual priority value used in uplink selection. When configuring an adjustment delta this may differ from the configured priority for an active uplink. Used to minimise uplink changes when an active uplink goes down and up again.
Path-Cost	The current path-cost. If auto configuration selected, this value is calculated based on port speed.
Speed/Duplex	Speed duplex on the uplink port. Only applicable for local uplinks.
Hello Time	The configured and effective (negotiated) hello-time on each unit.
Synchronized	A green check-box indicates this uplink has been synchronised with its neighbour at the remote end of the uplink. Only applicable for local uplinks.
Link Changes	Number of link changes. Only applicable for local uplinks.
Auto Refresh	Click on a value to make the page reload with updated statistics automatically every 5, 15, 30 or 60 seconds. Click Off to turn off auto refresh.
Refresh	Click on this button to reload with updated statistics.
Clear All	Click on this button to clear Topology Change Count and Time Since Last Change.

16.4 Managing FRNTv0 and v2 settings via the CLI

Command	Default	Section
<u>Configure FRNT settings</u>		
[no] frnt [RID] frntv0 [RID] frntv2 [RID]	RID 1	Section 16.4.1
[no] version <0 2>	Version 0	Section 16.4.2
[no] focal-point	Focal-point	Section 16.4.3
<u>FRNTv0 settings</u>		
ring-ports <PORT-M [, PORT-N]>		Section 16.4.4
[no] hello-time <time,time>	100 ms	Section 16.4.5
<u>FRNTv2 settings</u>		
[no] ring-interval <50-10000>	500 ms	Section 16.4.6
[no] blocked-port <PORT>	Auto	Section 16.4.7
[no] guarded-recovery	Enabled	Section 16.4.8
[no] port <PORT>		Section 16.4.9
[no] hello-time <20-10000>	500 ms	Section 16.4.10
[no] fwd-delay <3-60>	Disabled	Section 16.4.11
<u>Show and clear FRNT status/statistics</u>		
show frnt [all RID]		Section 16.4.12
frnt clear-stats <all RID>		Section 16.4.13

16.4.1 Managing FRNT

Syntax [no] frnt [RID] | frntv0 [RID] | frntv2 [RID]

Context [Global Configuration](#) context

Usage Enter FRNT Configuration context for the given RID "**frnt [RID]**", Ring ID.

With "**frnt [RID]**" the default FRNT version is 0 but in the FRNT Configuration context the version can be changed with the version command. "**frntv2 RID**" is a short cut to to enter FRNT version 2 context. (There is also a corresponding "**frntv0 RID**" command that does the same as "**frnt RID**".)

All FRNT instances in the same ring or sub-ring must be configured with the

same RID. If an FRNT ring instance receive control packets with a different RID than its own the packets will be discarded.

The FRNT instance is only activated upon the selection of valid FRNT ring ports, see [section 16.4.4](#).

Use **"no frnt [RID]"** to remove the existing FRNT instance with the RID. FRNTv0 and FRNTv2 instances can be removed with the **"no frntv0 [RID]"** and **"no frntv2 [RID]"**

Use **"show frnt"** to list configured FRNT settings (also available as **"show"** command within the FRNT Configuration context).

Default values Default RID is 1

16.4.2 FRNT version 0/2

Syntax [no] version <0|2>

Context [FRNT Configuration](#) context

Usage Configure FRNT version 0 or 2.

Use **"show version"** to show FRNT version.

Default value 0

16.4.3 FRNT focal point and member switch

Syntax [no] focal-point

Context [FRNT Configuration](#) context

Usage Configure device to act as FRNT focal point for this FRNT instance. Use **"focal-point"** to configure the device to act as an FRNT *focal-point*, and **"[no] focal-point"** to configure the device as an FRNT *member switch*.

Use **"show focal-point"** to show whether the unit is configured as focal-point or member switch

Default value focal-point

16.4.4 FRNTv0 Ring Ports

Syntax ring-ports <PORT-M [,PORT-N]>

Context [FRNT Configuration](#) version 0 context.

Usage Set the physical ports (Ethernet ports or SHDSL ports) to use as FRNT ports "M" and "N".

For FRNTv0 there is normally two FRNT ports named Port "M" and Port "N", configured by use the "**ring-ports <PORT-M ,PORT-N>**" command.

On a member switch Port "M" and "N" have similar roles, however, on a focal point their roles differ - when the ring is fully connected the focal point will put its Port "M" in BLOCKING state.

 **Note**

| For restrictions on how to select FRNT ports, see [section 16.1.4](#).

In the special case when you wish to configure a node as *FRNT Bus Edge*, you only configure port "M" ("**ring-ports <PORT-M>**").

Use "**show ring-ports**" to show configured FRNT ring port(s).

Default values Not applicable

16.4.5 FRNTv0 Hello time

Syntax hello-time <20-1000,20-1000>

Context [FRNT Configuration](#) version 0 context

Usage Set the hello time (msec) for Port "M" and Port "N". It is recommended to keep the default value for the hello time. When lowering the hello time below the default value, it is recommended to also limit the CPU bandwidth to approximately 256 kbit/s (see [section 8.3.6](#)).

Use "**show hello-time**" to show configured hello time for FRNT ring.

Default values 100 ms

16.4.6 FRNTv2 Ring Interval

Syntax [no] ring-interval <50-10000>

Context [FRNT Configuration](#) version 2 context

Usage Configures the interval (msec) of ring packets sent from focal point. The ring interval is used to verify the ring status so do not change the default value if unsure.

Use "**show ring-interval**" to show configured ring interval.

Default value 500 ms

16.4.7 FRNTv2 Blocked Port

Syntax [no] blocked-port <PORT>

Context [FRNT Configuration](#) version 2 context

Usage Configures the blocking port on focal point when the ring is *intact*. If not set (auto), the first configured ring port will be the blocked port. When focal point is configured as a sub-ring end switch, it will only have one configured ring port and then this port will be the blocked port.

For example, "**blocked-port 9**" will configure port 9 as blocking port, given that port 9 is a ring-port port.

"**no blocked-port**" will reset configuration to default (auto).

Use "**show ring-interval**" to show configured blocked port.

Default value Auto.

16.4.8 FRNTv2 Guarded Recovery

Syntax [no] guarded-recovery

Context [FRNT Configuration](#) version 2 context

Usage When guarded recovery is enabled FRNTv2 will use all ring control events to prevent loops in the network. When guarded-recovery is disabled only ring packets are used when deciding if the ring port on focal point should be in blocked or forward state. Leave this setting to default value if you are unsure of its function.

Default value Enabled.

16.4.9 FRNTv2 Ring Port configuration

Syntax [no] port <PORT>

Context [FRNT Configuration](#) version 2 context

Usage Enter FRNTv2 Port Configuration context for one FRNT ring port. Use **"no port <PORT>"** to remove the FRNT port.

Default value Not applicable.

16.4.10 FRNTv2 Hello Time

Syntax [no] hello-time <20-10000>

Context [FRNT Port Configuration](#) version 2 context

Usage Set the hello time in milliseconds.

"no hello-time" will disable qualification of the ring port with hello packets. When disabled, the ring port will be qualified immediately on link up.

Default values 500 ms.

16.4.11 FRNTv2 Forward Delay

Syntax [no] fwd-delay <3-60>

Context [FRNT Port Configuration](#) version 2 context

Usage Set the forward delay in seconds for port. If forward delay is set the port will change state to forwarding when the delay time has expired if no FRNT packets are received on the ring port. This is a setting for member switches and not on focal point to prevent the risk of a network loop.

For normal ring operation this setting should be disabled.

"no fwd-delay" will disable forward delay.

Default values Disabled.

16.4.12 Show FRNT ring status

Syntax show frnt [all|RID]

Context [Admin Exec](#) context.

Usage Show status of configured FRNT rings. Use **"show frnt"** to show an overview of all configured FRNT instances. **"show frnt RID"** will show a detailed view of the settings for the specified FRNT RID and **"show frnt all"** to show detailed view of all FRNT rings.

Example

```
example:/#> show frnt
```

Rid	Ver	Status	Top Cnt	Mode	Port 1	Port 2
1	0	OK	0	Focal	Eth 3 Blocking	Eth 4 Forwarding
10	2	OK	3	Focal	Eth 5 Qualified	

```
example:/#>
```

Note: A *focal point* switch will detect ring failures located anywhere in the ring, while a *member* switch can only detect local failures (local FRNT port is down, or if a neighbour is down).

Default values If no RID or keyword 'all' is provided, an overview of status of all FRNT Rings is shown.

16.4.13 Clear FRNT ring stats

Syntax frnt clear-stats <all|RID>

Context Admin Exec context.

Usage Clear Topology Change Count and Time Since Last Change for specified FRNT ring.

Default values Not applicable.

Example

```
example:/#> show frnt 1
```

```
=====
Ring#           : 1
Version         : 0
Enabled         : Yes,  running as PID 1309
Ring Status    : OK
Topology Change Count : 11
Time Since Last Change : 5 Days 2 Hours 3 Mins 14 Secs
Mode           : Focal Point
Port M         : Eth 9      UP  Blocking
Port N         : Eth 10     UP  Forwarding
```

```
example:/#> frnt clear-stats 1
```

```
example:/#> show frnt 1
```

```
=====
Ring#           : 1
Version         : 0
Enabled         : Yes,  running as PID 1309
Ring Status    : OK
```

```
Topology Change Count : 0
Time Since Last Change : 0 Days 0 Hours 0 Mins 8 Secs
Mode : Focal Point
Port M : Eth 9 UP Blocking
Port N : Eth 10 UP Forwarding
example:/#>
```

16.5 Feature Parameters

MAX_TOTAL_FRNT_INSTANCES	10
MAX_FRNTv0_INSTANCES	1
MAX_FRNTv2_INSTANCES	10

Chapter 17

FRNTv0 Ring Coupling and Multi-Link Dual Homing

This chapter describes WeOS *FRNTv0 Ring Coupling* and *Multi-Link Dual Homing*, two similar layer-2 (switching) fail-over functions.

FRNTv0 Ring Coupling enables bridging of two or more FRNTv0 rings via multiple layer-2 *uplinks*. Only one uplink is *active* at a time, while others are hot stand-by *backups*, providing redundancy and loop-free connectivity. It is also possible to use FRNT Ring Coupling to bridge an "FRNT bus" to an FRNT ring, thereby forming a horseshoe topology.

FRNTv0 Ring Coupling is not supported in FRNTv2, but the FRNTv2 sub-ring functionality can be used to create similar network topologies as with FRNTv0 and Ring Coupling, and FRNTv2 sub-rings is now the preferred method, see [section 16.1.2](#).

Multi-Link Dual-Homing (or simply "Dual-Homing") lets you connect a WeOS switch to a layer-2 topology via multiple *uplinks*. Optimal fail-over performance is achieved when connecting the dual-homing switch uplinks to a single FRNTv0 ring, or to two adjacent FRNTv0 rings (connected with Ring Coupling), but Dual-Homing can also be used in other layer-2 topologies.

Both FRNTv0 Ring Coupling and Multi-Link Dual-Homing provide fine-grained control of which *uplink* is to be preferred as *active*. By default, the link with highest speed/duplex mode is elected. To avoid shifting between active uplinks when a new uplink becomes available, a feature referred to as *sticky uplink* is provided. Enabling *sticky uplink* gives "zero" fail-over time on link-up and mitigates possi-

ble problems with flapping links.

Section 17.1 presents further information on FRNTv0 Ring Coupling and the Multi-Link Dual-Homing functionality. Web and CLI support for these features are covered in sections 17.2 and 17.3 respectively.

17.1 Overview

Feature	Web	CLI	General Description
FRNTv0 Ring Coupling	X	X	Section 17.1.1
Enable	X	X	
Ring Hello Interval	X	X	Section 17.1.1.2
Define Uplink(s)	X	X	Sections 17.1.1 and 17.1.3
Uplink Path-Cost	X	X	Section 17.1.3
Uplink Priority	X	X	-"
Uplink Echo Interval	X	X	Section 17.1.3
Ring Coupling Status	X	X	
Multi-Link Dual-Homing	X	X	Section 17.1.2
Enable	X	X	
Synchronized		X	Section 17.1.2.1
Multiple Instances		X	Section 17.1.2.2
Define Uplink(s)	X	X	Sections 17.1.2 and 17.1.3
Uplink Path-Cost	X	X	Section 17.1.3
Uplink Priority	X	X	-"
Uplink Echo Interval	X	X	-"
Dual-Homing Status	X	X	

17.1.1 FRNTv0 Ring Coupling

FRNTv0 Ring Coupling (RiCo) enables redundant bridging between two or more FRNTv0 rings. Fig. 17.1a shows a simple example where two RiCo nodes in an FRNTv0 *sub-ring* are connected with one uplink each to the FRNTv0 *super-ring*. A *super-ring* is a ring *without* RiCo nodes. It is possible to use more than two RiCo nodes in the sub-ring, and each RiCo node can have more than one uplink, as

shown in [fig. 17.1b](#). (Up to MAX_RING_COUPLING_UPLINKS ([section 17.4](#)) can be created.)

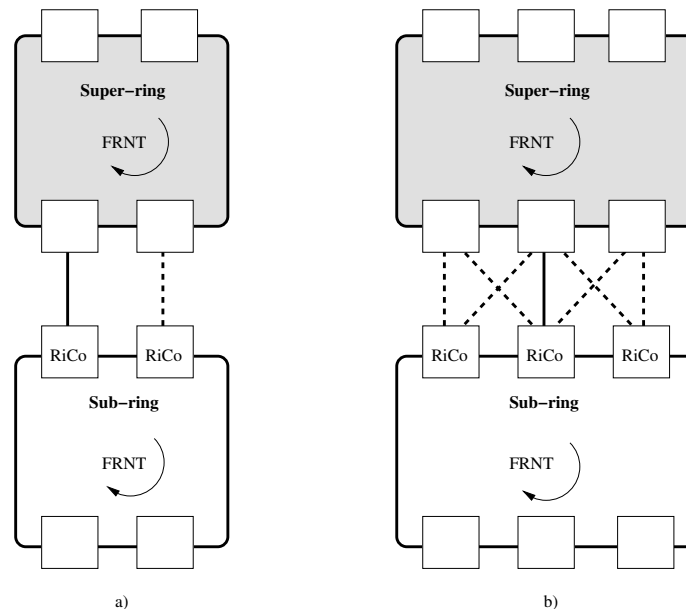

Figure 17.1: Ring Coupling with two FRNTv0 rings: (a) single uplinks, and (b) multiple uplinks per Ring Coupling node.

Only one of the uplinks is forwarding data – the *active uplink*, "solid" in [fig. 17.1](#), while the other uplink(s) are hot-standby backups, "dashed" in [fig. 17.1](#). To prevent traffic to flow over backup uplinks the RiCo nodes put all backup uplinks in *BLOCKING* state.



Note

RiCo nodes in the FRNT sub-ring exchange *RiCo Hello* messages to discover each other and elect which uplink to activate. These *Hello* messages are sent without a VLAN tag, implying that all nodes within the FRNTv0 sub-ring must have their FRNT ports associated with an **untagged VLAN** when using Ring Coupling. See [chapter 15](#) for information how to associate ports untagged to a VLAN.

In the CLI example below the leftmost Ring Coupling node in [fig. 17.1a](#) is a WeOS unit configured as an FRNT member switch (see [chapter 16](#)) with ring-ports '1' and '2', and port '3' as uplink.

 **Example**

```
example:/#> configure
example:/config/#> frnt
Activating FRNT0 with default settings, remember to change the ring ports!
Invalid settings: No ring ports defined
example:/config/frnt-1/#> ring-ports 1,2
example:/config/frnt-1/#> no focal-point
example:/config/frnt-1/#> coupling
Creating new instance 1
example:/config/frnt-1/coupling-1/#> uplink 3
example:/config/frnt-1/coupling-1/uplink-eth3/#> priority 100
example:/config/frnt-1/coupling-1/uplink-eth3/#> leave
Starting Fast Redundant Network Topology v0 daemon ..... [ OK ]
Starting Ring bridging/dual-homing daemon ..... [ OK ]
Configuration activated. Remember "copy run start" to save to flash (NVRAM).
example:/#>
```

Here, the *uplink priority* was given the value "**100**" to make it the preferred active uplink. The default is 128, for further details see [section 17.1.3](#).

It is of course possible to connect multiple sub-rings to one super-ring. The uplinks from the sub-rings can be connected to *individual* nodes in the super-ring (see [fig. 17.2a](#)) or the nodes in the super-ring can be *shared*, see [fig. 17.2b](#).

The topology can be extended even further by connecting sub-rings to sub-rings in a tree structure with a super-ring as *root*. [Fig. 17.3](#) shows two examples, a ladder topology (a) and a tree topology (b).

17.1.1.1 Ring Coupling and Routing

FRNTv0 Ring Coupling is a function to connect FRNTv0 rings at layer-2 (switching). This improves capacity and failover performance compared to layer-3 (routing) mechanisms such as OSPF ([chapter 29](#)). Nevertheless, routing techniques have good scalability characteristics as the network is segmented into different broadcast domains.

Although technically feasible, it is *strongly recommend* to separate ring coupling and routing, localising the distinct functions in dedicated WeOS units, i.e., do not use RiCo nodes also as routers.

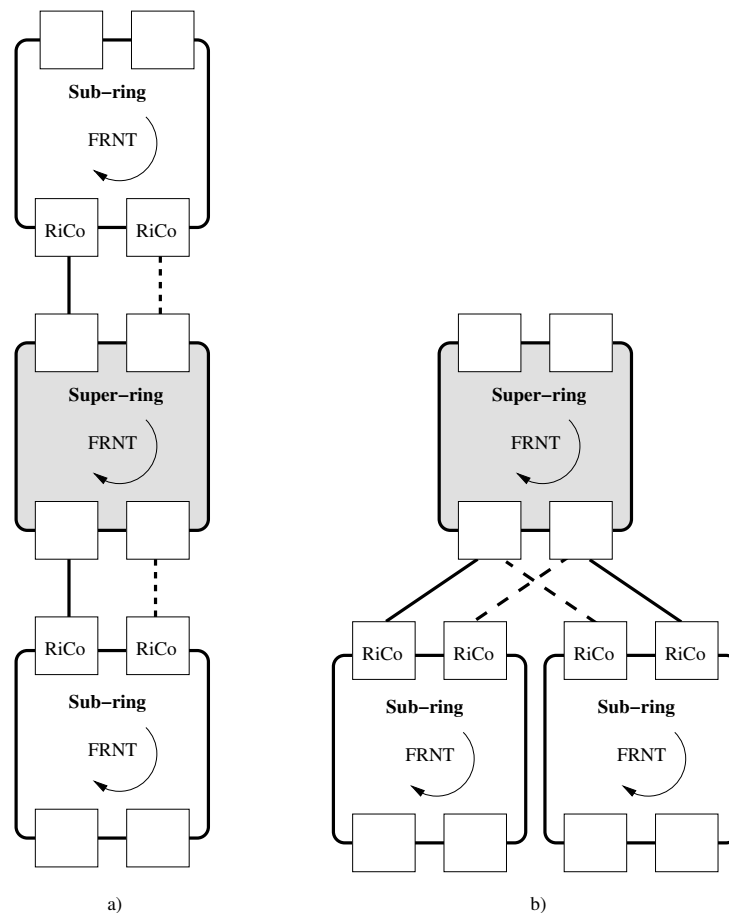

Figure 17.2: Two sub-rings connecting to (a) individual nodes in the super-ring, or (b) shared nodes in the super-ring.



Note

In some cases using RiCo nodes as routers makes sense. To ensure correct operation of the RiCo node, the CPU bandwidth is reduced by default, i.e., when **"cpu-bandwidth-limit"** is set to **"auto"** (section 8.3.6) on a WeOS unit configured for FRNTv0 Ring Coupling or Multi-link Dual-Homing. This in turn reduces routing performance.

This automatic reduction of CPU bandwidth can be overridden by changing the CPU bandwidth limit setting (section 8.3.6).

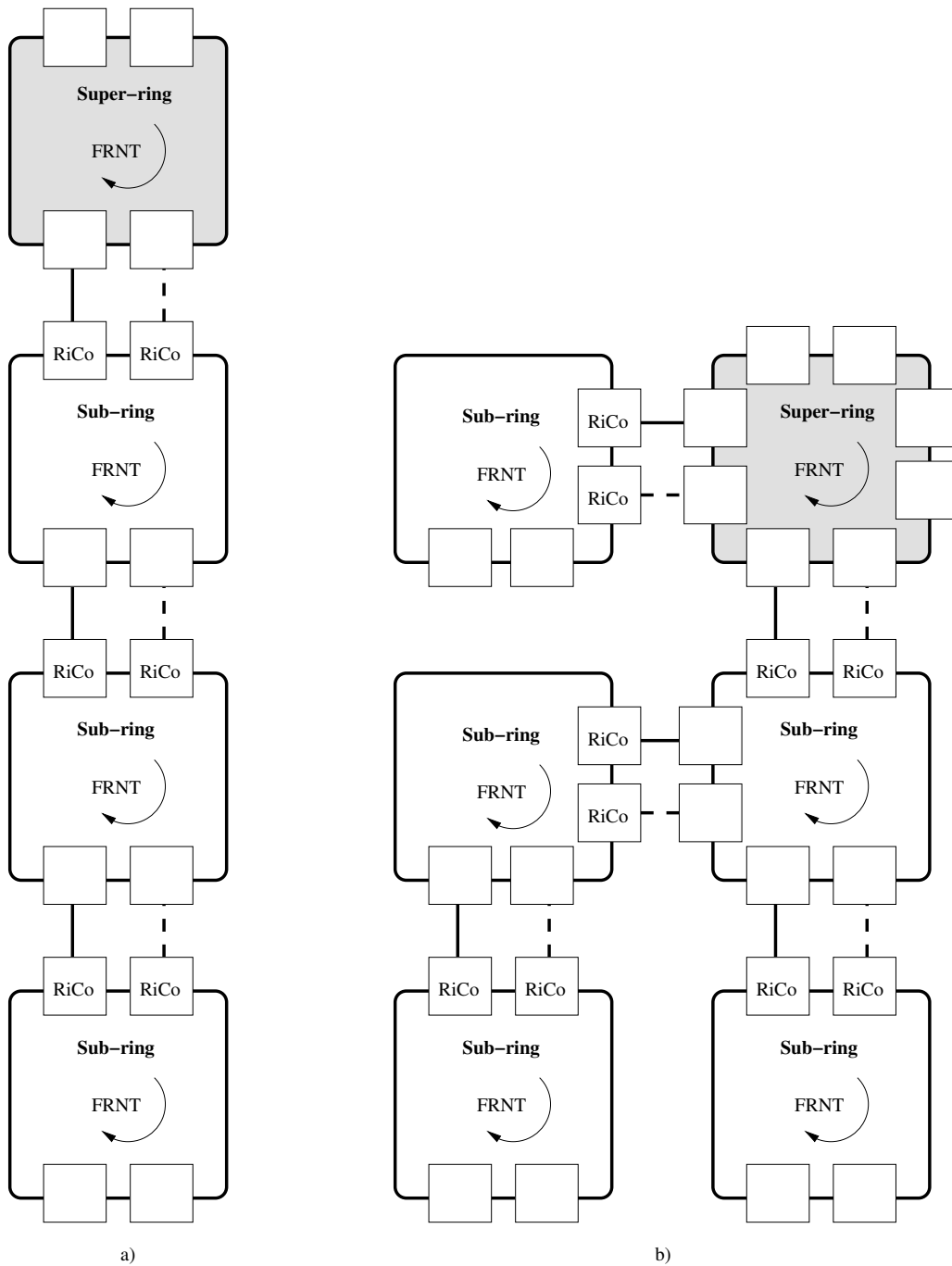

Figure 17.3: Examples of tree topologies: (a) shows a "ladder" (a tree without branches), and (b) a more generic tree of FRNTv0 rings.

17.1.1.2 Ring Coupling Hello Interval

RiCo nodes in the same FRNTv0 ring exchange *Hello* messages to discover each other as part of the active uplink election process, see also [section 17.1.3](#). These *Hello* messages are transmitted every 100 ms by default on the FRNTv0 ring ports. The *hello interval* can be fine tuned – a lower value gives faster failover, but may have an adverse effect on the CPU usage. When the CPU usage increases RiCo nodes may not be able to send *Hello* messages and will time out. This can lead to unpredictable performance and loss of connectivity.

It is recommended that all RiCo nodes within an FRNTv0 ring are configured with the same Hello interval. If there are RiCo nodes with different Hello interval in an FRNTv0 ring, the protocol will default to the highest interval announced by any RiCo node, i.e., a RiCo node's *effective hello interval* may differ from its *configured hello interval*. E.g., if you wish to transition from using **"hello-time 100"** to **"hello-time 80"**, all RiCo nodes will use interval 100 ms until all RiCo node's in the FRNTv0 ring has been configured with interval 80 ms.

Note

Configuring RiCo nodes with the same RiCo Hello interval is particularly important when forming a Horseshoe topology ([section 17.1.1.3](#)) by connecting RiCo uplinks via an FRNTv0 bus.

17.1.1.3 Horseshoe topologies by use of Ring Coupling and FRNTv0 Bus

Note

Please see [section 16.1.2.1](#) for a better way of forming *horseshoe* topologies using *FRNTv2*. The information below is kept to document an alternative approach used before *FRNTv2* was introduced.

In some case you may wish to extend the FRNTv0 super-ring with a "horseshoe" network rather than connecting an FRNTv0 sub-ring to the super-ring. Such a topology is shown in [fig. 17.4](#) by use of Ring Coupling together with an "FRNT bus" ([section 16.1.2.2](#)).

The use of an *FRNTv0 bus* rather than an *FRNTv0 ring* in the "sub-network" can be motivated when:

- When you do not have the *cable* needed or spare ports available to connect the nodes in the "sub-network" together in a ring.

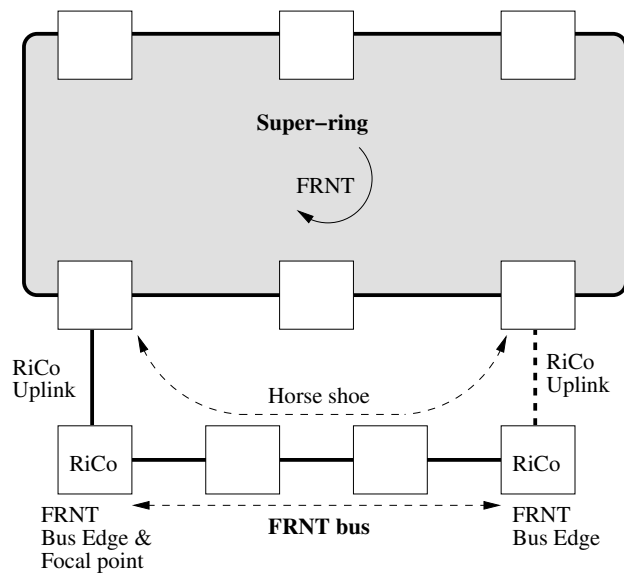

Figure 17.4: Adding "horseshoe" to FRNT super-ring by use of Ring Coupling and FRNT bus.

- If the additional robustness and failover performance, achieved by forming the "sub-network" as a ring, is of less importance.

17.1.2 Multi-Link Dual-Homing

Multi-Link Dual-Homing makes it possible for a WeOS dual-homing node to have redundant connections to an FRNTv0 ring. Fig. 17.5 shows an example where two dual-homing nodes are connected to the FRNTv0 ring with two connections each.

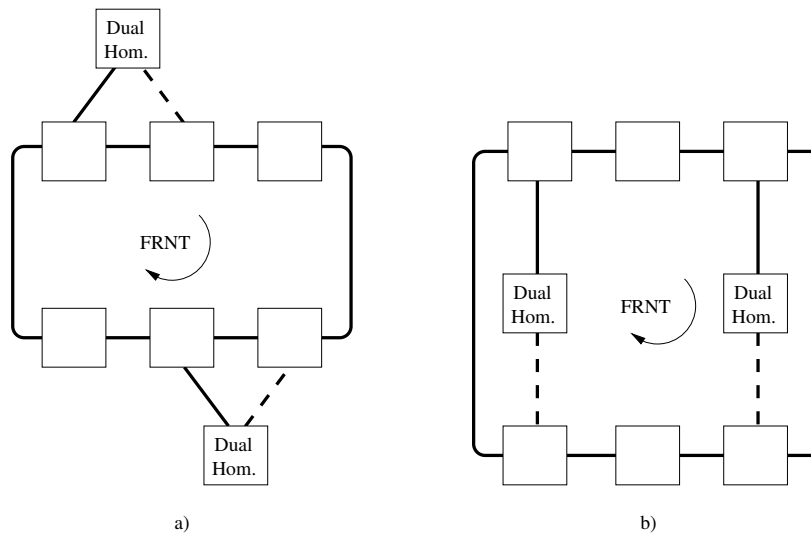

Figure 17.5: Dual-Homing with single FRNTv0 ring (super-ring). (a) and (b) show the same topology in different ways.

Consider one of the dual-homing nodes in fig. 17.5a, assuming it is a WeOS switch with Ethernet ports '1' and '2' as uplinks, and where port '1' is to be active by default. A possible configuration is given below:

```

Example
example:/#> configure
example:/config/#> dual-homing
Creating new instance 1
example:/config/dual-homing-1/#> uplink 1
example:/config/dual-homing-1/uplink-eth1/#> priority 100
example:/config/dual-homing-1/uplink-eth1/#> end
example:/config/dual-homing-1/#> uplink 2
example:/config/dual-homing-1/uplink-eth2/#> leave
Starting Ring bridging/dual-homing daemon ..... [ OK ]
Configuration activated. Remember "copy run start" to save to flash (NVRAM).
example:/#>
    
```

**Note**

It is possible to connect uplinks of a WeOS dual-homing switch to any layer-2 topology, but failover performance is optimised for FRNTv0 rings.

When connecting uplinks to LAN topologies other than FRNTv0 the *synchronised* option in dual-homing must be disabled, see [section 17.1.2.1](#), otherwise the uplinks will not come up.

[Section 17.1.2.1](#) describes the *synchronised dual-homing* function, illustrates how you can combine Multi-Link Dual-Homing and FRNTv0 Ring Coupling, supporting topologies where you can connect the dual-homing uplinks to two adjacent FRNTv0 rings.

[Section 17.1.2.2](#) presents the possibility of using multiple instances of dual-homing.

17.1.2.1 Synchronized Dual-Homing

WeOS Multi-Link Dual-Homing provides a mechanism referred to as *synchronised dual-homing*. Synchronised dual-homing has two purposes:

- *Integrity of the uplink*: A dual-homing switch monitors uplink connectivity by exchanging specific *echo packets* with the remote switch. This ensures that a link break is detected even in cases where intermediate transceivers do not propagate link down.
- *Define preferred uplink when connecting two adjacent FRNTv0 rings*: It is possible to connect the uplinks of a dual-homing node to two adjacent FRNTv0 rings, which in turn are connected by ring coupling. The synchronised dual-homing feature will give preference to the uplink connected to a ring coupling *sub-ring*, i.e., the ring containing the RiCo nodes. More details later in this section.

If you wish to connect a dual-homing switch to topologies other than FRNTv0 you need to disable the synchronised dual-homing feature in the dual-homing node. An example is given below where ports 1 and 2 are configured as uplinks to non-FRNTv0 nodes.

**Example**

```
example:/#> configure
example:/config/#> dual-homing
Creating new instance 1
example:/config/dual-homing-1/#> uplink 1
```

```
example:/config/dual-homing-1/uplink-eth1/#> priority 100
example:/config/dual-homing-1/uplink-eth1/#> end
example:/config/dual-homing-1/#> uplink 2
example:/config/dual-homing-1/uplink-eth2/#> end
example:/config/dual-homing-1/#> no synchronized
example:/config/dual-homing-1/#> leave
Starting Ring Coupling/Dual-Homing daemon ..... [ OK ]
Configuration activated. Remember "copy run start" to save to flash (NVRAM).
example:/#>
```

Additional remarks if you intend to use dual-homing to connect the uplinks to other nodes than FRNT nodes.

- *Fail-over performance:* Fail-over performance is optimised when connecting the dual-homing node to a single FRNTv0 ring, or to two FRNTv0 rings. (Which in turn may be connected by FRNTv0 ring coupling). In other topologies the switches may temporarily have stale MAC entries in their learning caches for a short period of time (unicast traffic). Furthermore, if IGMP snooping is used multicast traffic will also be disrupted until switches receive new IGMP Reports via the new uplink.
- *Integrity of the uplink:* With synchronised dual-homing disabled, the uplink status is determined based on its physical status (up/down). If you wish additional control in this case, you could consider running LACP on the uplink, i.e., you could create a link-aggregate with the uplink as the only member link. See [chapter 20](#) for further information on LACP and link aggregation.

It is possible to combine the use of Multi-Link Dual-Homing and FRNTv0 Ring Coupling. [Fig. 17.6](#) shows how a dual-homing node can be connected to two adjacent FRNTv0 rings, and [fig. 17.7](#) illustrates an example with several dual homing nodes.

The *synchronised dual-homing* feature will give preference to the uplink leading to the FRNTv0 ring containing RiCo nodes (the ring coupling "sub-ring"). This means that the 'left' dual-homing uplink (port '1') in [fig. 17.6](#) will be active as long as a RiCo node in that ring is reachable, and in turn has an active uplink.

To ensure that the dual-homing node fail-over to the other uplink (the 'right' uplink (port '2') in [fig. 17.6](#)) if no RiCo node is reachable via the sub-ring, port '2' should be configured with better uplink *priority*, see also [section 17.1.3](#). A configuration example is given below.

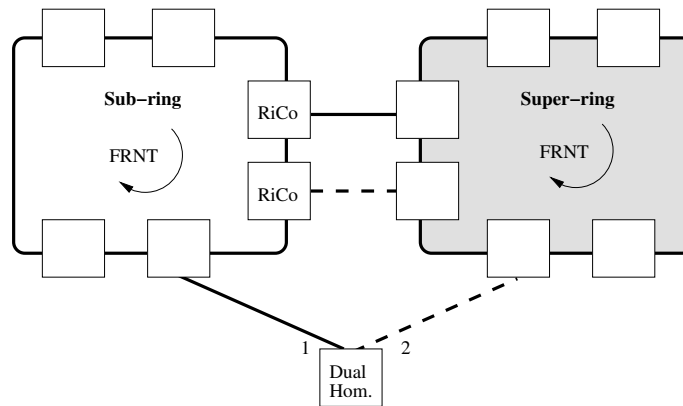

Figure 17.6: Dual-Homing used in an FRNTv0 Ring Coupling Topology.

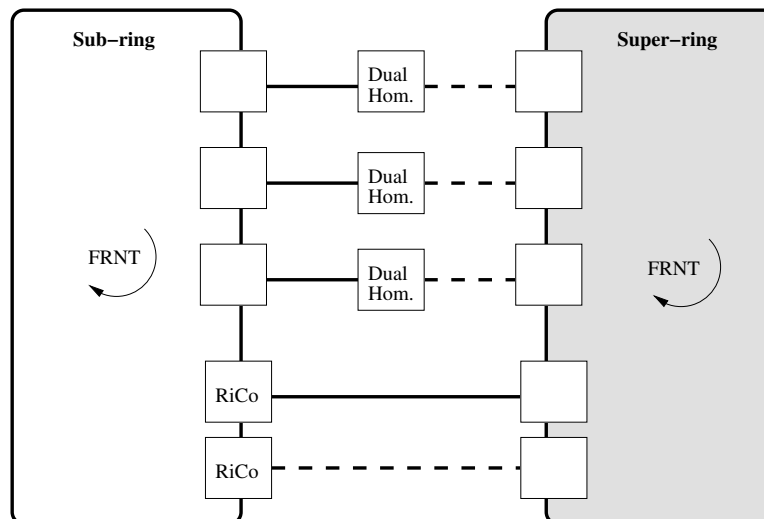

Figure 17.7: Multiple Dual-Homing nodes in an FRNTv0 Ring Coupling Topology.

Example

```
example:/#> configure
example:/config/#> dual-homing
Creating new instance 1
example:/config/dual-homing-1/#> uplink 1
example:/config/dual-homing-1/uplink-eth1/#> end
example:/config/dual-homing-1/#> uplink 2
example:/config/dual-homing-1/uplink-eth2/#> priority 100
example:/config/dual-homing-1/uplink-eth2/#> leave
```

```
Starting Ring Coupling/Dual-Homing daemon ..... [ OK ]  
Configuration activated. Remember "copy run start" to save to flash (NVRAM).  
example:/#>
```

17.1.2.2 Multiple instances of Dual-Homing

It is possible to create multiple dual-homing instances on a WeOS switch. Each instance has its own set of uplinks, referred to as an *uplink domain* – one of the uplinks in the domain will be active, while the others are backups. A sample topology is shown in fig. 17.8.

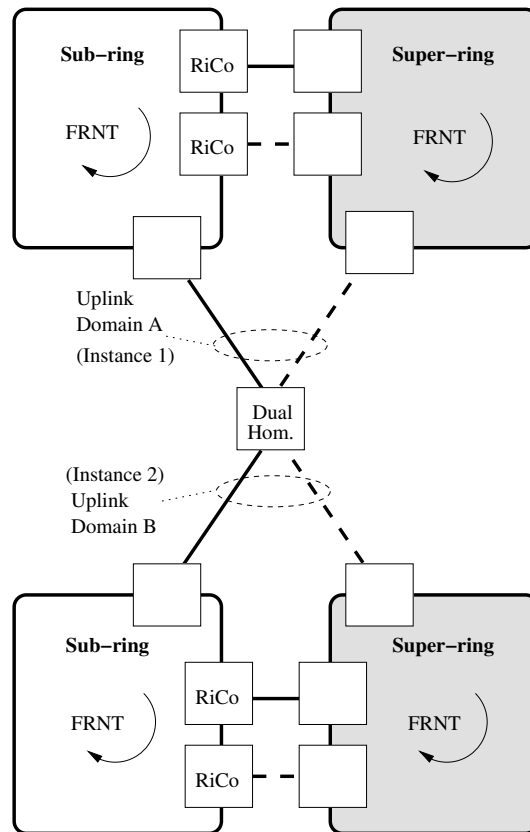

Figure 17.8: Possibility to setup multiple uplink domains for dual-homing.

**Warning**

The upper and lower LANs in [fig. 17.8](#) **must not** have additional interconnections. Otherwise a layer-2 loop would be created via the dual-homing node, unless the dual-homing node has VLAN barriers between uplinks of the different instances.

17.1.3 Active uplink election

Both FRNTv0 Ring Coupling and Multi-Link Dual Homing makes use of an uplink election mechanism to determine which of the available uplinks that should become *active* and which should be *backups*. For Dual-Homing, the election is handled within the dual-homing node itself, but for FRNTv0 ring coupling the election process the RiCo nodes in the FRNTv0 ring negotiate which uplink should be active.

Only uplinks which are *up* are considered when electing the active uplink. To ensure that an uplink is *up*, RiCo and Dual-Homing nodes send *Uplink Echo* packets which are returned by the FRNTv0 node at the other end of the uplink. Thus, a RiCo and Dual-Homing node will only consider an uplink to have status *up* if it is physically up, and if it receives responses to its *Uplink Echo* packets (loss of 3 packets indicates link down). These *Hello* messages are transmitted every 200 ms by default on the uplink ports. The *uplink echo interval* can be fine tuned – a lower value gives faster failover, but may have an adverse effect on the CPU usage. For Dual-Homing, the Uplink Echo message exchange can be disabled, thereby enabling the dual-homing node to be connected other networks than FRNT, see [section 17.1.2.1](#).

To determine which of the available uplinks that is preferred, an *cost vector* is formed for every uplink and compared. The uplink with the *lowest cost vector* is elected as active uplink¹. The cost vector consists of the following fields.

- *Link speed/duplex Cost*: The most significant component of the cost vector depends on the link's speed and duplex setting. This link speed/duplex component is calculated as shown in [table 17.2](#), similar to link cost calculation in RSTP (see [section 18.1.3](#)). It is also possible to configure the link speed/duplex cost manually. Default: **Auto** (see [table 17.2](#))

¹The exception is dual-homing with synchronised dual-homing enabled. Then uplinks to FRNTv0 rings with reachable Ring Coupling nodes have precedence over other uplinks, see also [section 17.1.2.1](#).

- *Priority*: The next component of the cost vector is the uplink *priority*, which is used when two or more uplinks have the same link speed/duplex cost. Then the uplink with the *lowest priority value* is elected as active uplink. Default: **128**
- *Base MAC address*: (Only for Ring Coupling) If *link speed/duplex cost* and *uplink priority* are equal for two RiCo nodes, the node with the lowest base-MAC address will win.
- *Link/port identity*: Finally, if all other components are equal, the port with the lowest port number is elected as *active*.

Bandwidth	Full Duplex	Half Duplex	Two Aggregated Links
10 Mbps	2,000,000	4,000,000	1,000,000
100 Mbps	200,000	400,000	100,000
1 Gbps	20,000	40,000	10,000

Table 17.2: Link speed & duplex to link cost component translation table. For aggregated links (see [chapter 20](#)) the link speed/duplex cost is half the cost of a single link for the given link speed and duplex mode. This is shown in the right-most column.

To mitigate issues with flapping uplinks, e.g., caused by bad cables, dual-homing nodes and ring coupling nodes can be configured to use a *sticky uplink*, as opposed to the *deterministic uplink* election described above. With sticky uplink enabled, the *priority* component of an uplink's cost vector is reduced with a given value (the *adjustment value*) once that link is elected as *active*. That is, with sticky uplink configured, the *effective priority* of an uplink can differ from the *configured priority*.

Example

Consider three uplinks with same speed and duplex. *Link A* has "**priority 100**", *link B* has "**priority 110**" with "**adjustment 20**", and *link C* has "**priority 120**" with "**adjustment 40**". All nodes keep information about each others announced link cost (100, 110 and 120). If *Link A* goes down, *link B* will take over as it has lower (i.e., better) priority than *link C* (110<120), and *link B* will decrease its effective priority to 90 in its announcements.

If *link A* comes up again, *link B* will continue to be active as "90<100". The

mechanism works in the same way for dual-homing, even though priority is never "announced" to any other node.

17.1.4 Handling Multicast

To provide fast fail-over of multicast traffic, FRNTv0 Ring Coupling and Multi-Link Dual-Homing uplinks are added to the list of *multicast router ports*, see [section 21.1.1](#). This is both done at the Ring Coupling nodes and Dual-Homing nodes, as well as on switches on the remote side of the uplink². This means that all layer-2 multicast traffic is always sent over the uplinks, even if IGMP snooping is enabled.

²An exception is when connecting a Dual-Homing uplink to a non-FRNTv0 switch, the fail-over of multicast traffic will instead occur on the next reception of an IGMP Report (if IGMP snooping is enabled). See also [section 17.1.2.1](#).

17.2 Managing via the Web

17.2.1 Managing FRNTv0 Ring Coupling Settings





FRNTv0 ring couplings are set up in the FRNT context, see [section 16.3.1](#) for further information.

17.2.2 Managing Dual-Homing Settings



Menu path: Configuration ⇒ L2 Redundancy ⇒ Dual-Homing

Here the list of currently configured Dual-Homing instances is found.

Dual-Homing

ID	Enabled	Uplinks	Synchronized		
0x0001	✓	eth 1, eth 2	—		
0x0007	✓	eth 3, eth 4	✓		

New

ID	A unique identifier for the dual-homing instance.
Enabled	A green checkbox if the dual-homing instance is enabled, a minus sign if not.
Uplinks	A list of the uplinks configured for this dual-homing instance.
Synchronized	A green check-box indicates this uplink has been synchronised with its neighbour.
 Edit	Click this icon to edit a dual-homing instance.
 Delete	Click this icon to remove a dual-homing instance.

Use the **New** button to create a new Dual-Homing instance.

Up to MAX_DUAL_HOMING_INSTANCES ([section 17.4](#)) can be created.

Edit Dual-Homing

ID	0x0001				
Enabled	<input checked="" type="checkbox"/>				
Synchronized	<input checked="" type="checkbox"/>				
Uplinks	Port	Priority	Adjustment	Echo Interval	Path-Cost
	Eth 1	<input type="text" value="256"/>	<input type="text" value="25"/>	<input type="text" value="200"/>	Auto <input type="checkbox"/> <input type="text" value="4096"/>
	Eth 2	<input type="text" value="128"/>	<input type="text" value="0"/>	<input type="text" value="250"/>	Auto <input checked="" type="checkbox"/> <input type="text" value=""/>

Enabled	Check/uncheck box to enable/disable dual-homing instance.
Synchronized	Check/uncheck box to enable/disable <i>Synchronized</i> mode which requires synchronisation with its neighbour.
Uplinks	
Port	The uplink port.
Priority	The uplinks priority. Used for calculating active uplink.
Adjustment	Priority adjustment delta for this uplink. Makes the uplink sticky by adjusting the effective priority with this value when uplink becomes active.
Echo Interval	The interval (ms) between packets sent to the uplink neighbour to verify uplink connectivity.
Path Cost	The uplinks path cost. Used for calculating active uplink. Auto (check-box checked) indicates path-cost is automatically calculated (based on link speed).
Delete	Click this icon to remove a dual-homing instance.
Add	Click this icon to add a new dual-homing instance.

17.2.3 Dual-Homing Status and Statistics

Menu path: Status ⇒ L2 Redundancy ⇒ Dual-Homing

On this page dual-homing status and statistics is presented.

Dual-Homing Status

Instance 1

Port	Active	Effective Priority	Path-Cost	Speed/Duplex	Synchronized	Preferred
eth 3	✓	128	200000	100 Full	✓	✓
eth 5		128	100000	10 Full	✓	☐

Instance 2

Port	Active	Effective Priority	Path-Cost	Speed/Duplex	Synchronized	Preferred
eth 1	✓	128	200000	100 Full	✓	✓
eth 2		256	200000	100 Full	✓	☐

Auto-Refresh: Off, [5s](#), [15s](#), [30s](#), [60s](#)

Refresh

Figure 17.9: Dual-homing status and statistics in web

Port	The uplink port name.
Active	A green check-mark indicates this is the active uplink for the dual-homing instance.
Effective Priority	The actual priority value used in uplink selection. When configuring an adjustment delta this may differ from the configured priority for an active uplink. Used to minimise uplink changes when an active uplink goes down and up again.
Path-Cost	The current path-cost. If auto configuration selected, this value is calculated based on port speed.
Speed/Duplex	Speed duplex on the uplink port.
Synchronized	A green check-box indicates this uplink has been synchronised with its neighbour at the remote end of the uplink. Only applicable for local uplinks.
Preferred	A green check-box indicates this uplink is preferred.

Continued on next page

Continued from previous page

Auto Refresh	Click on a value to make the page reload with updated statistics automatically every 5, 15, 30 or 60 seconds. Click Off to turn off auto refresh.
Refresh	Click on this button to reload with updated statistics.

17.3 Managing via CLI

Command	Default	Section
<u>Configure Ring Coupling Settings</u>		
frnt		Sec. 16.4.1
[no] coupling [ID]	1	Sec. 17.3.1
[no] enable	Enabled	Sec. 17.3.2
[no] hello-interval <50..10000>	100 (msec)	Sec. 17.3.3
[no] uplink <PORT>		Sec. 17.3.4
[no] path-cost <auto <COST>>	Auto	Sec. 17.3.5
[no] priority <1..65535> [adjust <DELTA>]	128	Sec. 17.3.6
[no] echo-time <20..1000>	200 (msec)	Sec. 17.3.7
<u>Configure Multi-Link Dual-Homing Settings</u>		
[no] dual-homing [ID]	1	Sec. 17.3.8
[no] enable	Enabled	Sec. 17.3.9
[no] synchronized	Enabled	Sec. 17.3.10
[no] uplink <PORT>		Sec. 17.3.11
[no] path-cost <auto <COST>>	Auto	Sec. 17.3.12
[no] priority <1..65535> [adjust <DELTA>]	128	Sec. 17.3.13
[no] echo-time <20..1000>	200 (msec)	Sec. 17.3.14
<u>FRNTv0 Ring Coupling and Multi-Link Dual-Homing Status</u>		
show coupling		Sec. 17.3.15
show dual-homing [ID]		Sec. 17.3.16

17.3.1 Managing FRNTv0 Ring Coupling

Syntax [no] coupling [ID]

Context [FRNT Configuration](#) context

Usage Use **"coupling ID"** to enter FRNT Ring Coupling Configuration context of the given Ring Coupling instance ID. Currently only a single Ring Coupling instance is supported, thus the value of the coupling ID is ignored. **"coupling ID"** creates an FRNT Ring Coupling instance unless it already exists.

Use **"no coupling"** to remove the ring coupling instance.

Use **"show coupling"** to show configuration information for the ring coupling instance. (Also available as **"show"** command within the FRNT Ring Coupling Configuration context.)

Default values Default ID is 1

17.3.2 Enable/Disable FRNTv0 Ring Coupling

Syntax [no] enable

Context FRNT Ring Coupling Configuration context

Usage Enable or disable an FRNTv0 Ring Coupling instance. Use **"enable"** to enable the coupling instance, and **"no enable"** to disable the coupling instance (without losing configuration settings for this instance).

Use **"show enable"** to show whether the coupling instance is enabled or disabled.

Default values Enabled

17.3.3 Set FRNTv0 Ring Coupling Hello Interval

Syntax [no] hello-interval <50..10000>

Context FRNT Ring Coupling Configuration context

Usage Use **"hello-interval VALUE"** to set the hello interval (in milliseconds) to be announced by his ring coupling node.

 **Note**

The *effective hello-interval* used will be the highest interval announced by any ring coupling node in the FRNTv0 ring.

"no hello-interval" resets the configured hello interval to the default setting (100 milliseconds).

Use **"show hello-interval"** to show the configured hello interval.

Default values 100 (msec)

17.3.4 Managing FRNTv0 Ring Coupling Uplink Ports

Syntax [no] uplink [PORT]

Context FRNT Ring Coupling Configuration context

Usage Use **"uplink PORT"** to define the given port as uplink for this ring coupling node, and enter the Ring Coupling Uplink Configuration context for the port. A port can be an Ethernet port ([chapter 10](#)), a DSL port ([chapter 12](#) and [chapter 13](#)), or a link aggregate ([chapter 20](#)).

Up to MAX_RING_COUPLING_UPLINKS ([section 17.4](#)) can be created.

Use **"no uplink PORT"** to remove the give port as uplink for this ring coupling node, or use **"no uplink"** to remove all uplinks for the node.

Use **"show uplink"** to list configuration information for all uplinks, and **"show uplink PORT"** to list uplink configuration settings for the given port (also available as **"show"** command within the Ring Coupling Uplink Configuration context for the port.)

Default values Not applicable

17.3.5 Set Ring Coupling Uplink Path-Cost

Syntax [no] path-cost <auto|COST>

Context Ring Coupling Uplink Configuration context

Usage Configure uplink path-cost. By default, the path-cost depends on the link speed and duplex mode (higher speed gives lower cost). It is also possible to set a cost manually in range $1..2^{32}-1$ (1..4294967295).

The *path-cost* is used when electing the active uplink – the link with the lowest cost will be the active uplink. If the costs of two uplinks are equal, their *uplink priority* ([section 17.3.6](#)) is considered. For more details, see [section 17.1.3](#).

Use **"path-cost auto"** to have the uplink's path-cost depend on its link speed and duplex mode. Use **"path-cost COST"** to set a static path-cost for the uplink. **"no path-cost"** will reset the path cost to the default setting (auto).

"show path-cost" will show the configured uplink path-cost.

Default values Auto

17.3.6 Set Ring Coupling Uplink Priority

Syntax [no] priority <1..65535> [adjust <DELTA>]

Context Ring Coupling Uplink Configuration context

Usage Configure uplink priority, and optionally enable *sticky* uplink election by setting adjust value.

- Use **"priority VALUE"** to set priority value. A lower value increases the chance for this uplink to be elected as active uplink (lower is better). With equal path-cost (section 17.3.5), an uplink with **"priority 100"** is preferred as uplink over an uplink with **"priority 110"**.
- Use the optional **"adjust DELTA"** setting to *improve* its priority (i.e., *lower* its priority with the specified **"DELTA"**) once the uplink is elected as active uplink. This gives a *sticky* uplink behaviour where shifting active uplink will be less common.

Consider the following example with *uplink A* (**"priority 100"**), *uplink B* (**"priority 110 adjust 20"**), and *uplink C* (**"priority 120 adjust 40"**), and where *uplink A* came up first and is the active uplink. If *uplink A* goes down, *uplink B* takes over as it has lower priority than *uplink C* (110 < 120). *Uplink B* will then apply its adjustment and announce priority to 90 (110 – 20) in its *hello* messages. Uplink B will stay as active uplink even if uplink A comes up again (90 < 100).

"show priority" will show the configured uplink priority.

Default values priority 128 (no adjustment)

17.3.7 Set Ring Coupling Uplink Echo Interval

Syntax [no] echo-time <20..1000>

Context Ring Coupling Uplink Configuration context

Usage Use **"echo-time VALUE"** to set the uplink echo interval (in milliseconds) to check the integrity of the uplink.

"no echo-time" resets the configured echo interval to the default setting (200 milliseconds).

Use **"show echo-time"** to show the configured echo interval.

Default values 200 (msec)

17.3.8 Managing Multi-Link Dual-Homing

Syntax [no] dual-homing [ID]

Context [Global Configuration](#) context

Usage Use **"dual-homing ID"** to enter the Dual-Homing Configuration context of the given Dual-Homing instance ID. Default instance ID is "1", thus command **"dual-homing"** will enter the context of dual-homing instance 1. **"dual-homing ID"** creates a dual-homing instance with given ID, unless it already exists.

Up to MAX_DUAL_HOMING_INSTANCES ([section 17.4](#)) can be created.

Use **"no dual-homing ID"** to remove a specific dual-homing instance, or **"no dual-homing"** to remove all dual-homing instances.

Use **"show dual-homing"** to list configuration information on all dual-homing instances, and **"show dual-homing ID"** for configuration information on a specific dual-homing instance (also available as **"show"** command within the Dual-Homing Configuration context).

Default values Default ID is 1

17.3.9 Enable/Disable Multi-Link Dual-Homing

Syntax [no] enable

Context [Dual-Homing Configuration](#) context

Usage Enable or disable a dual-homing instance. Use **"enable"** to enable the dual-homing instance, and **"no enable"** to disable the dual-homing instance (without losing configuration settings for this instance).

Use **"show enable"** to show whether the dual-homing instance is enabled or disabled.

Default values Enabled

17.3.10 Synchronized Multi-Link Dual-Homing

Syntax [no] synchronized

Context [Dual-Homing Configuration](#) context

Usage Enable or disable the dual-homing *synchronisation* feature. When enabled, preference when selecting active uplink will be given to uplinks where the uplink peer announces that it has connectivity to ring-coupling node with active uplink. See [section 17.1.2.1](#) for more information.

Use **"synchronized"** to enable and **"no synchronized"** to disable synchronised dual-homing.

Use **"show synchronized"** to show whether synchronised dual-homing is enabled or disabled.

Default values Enabled

17.3.11 Managing Multi-Link Dual-Homing Uplink Ports

Syntax [no] uplink [PORT]

Context [Dual-Homing Configuration](#) context

Usage Use **"uplink PORT"** to define the given port as uplink for this dual-homing node, and enter the Dual-Homing Uplink Configuration context for the port. A port can be an Ethernet port ([chapter 10](#)), a DSL port ([chapter 12](#) and [chapter 13](#)), or a link aggregate ([chapter 20](#)).

Up to MAX_DUAL_HOMING_UPLINKS ([section 17.4](#)) can be created.

Use **"no uplink PORT"** to remove the give port as uplink for this dual-homing node, or use **"no uplink"** to remove all uplinks for the node.

Use **"show uplink"** to list configuration information for all uplinks, and **"show uplink PORT"** to list uplink configuration settings for the given port (also available as **"show"** command within the Dual-Homing Uplink Configuration context for the port.)

Default values Not applicable

17.3.12 Set Multi-Link Dual-Homing Uplink Path-Cost

Syntax [no] path-cost <auto|COST>

Context [Dual-Homing Uplink Configuration](#) context

Usage Configure uplink path-cost. By default, the path-cost depends on the link speed and duplex mode (higher speed gives lower cost). It is also possible to set a cost manually in range 1..2³²-1 (1..4294967295).

The *path-cost* is used when electing the active uplink – the link with the lowest cost will be the active uplink. If the costs of two uplinks are equal, their *uplink priority* (section 17.3.13) is considered. For more details, see section 17.1.3.

Use **"path-cost auto"** to have the uplink's path-cost depend on its link speed and duplex mode. Use **"path-cost COST"** to set a static path-cost for the uplink. **"no path-cost"** will reset the path cost to the default setting (auto).

"show path-cost" will show the configured uplink path-cost.

Default values Auto

17.3.13 Set Multi-Link Dual-Homing Uplink Priority

Syntax [no] priority <1..65535> [adjust <DELTA>]

Context Dual-Homing Uplink Configuration context

Usage Configure uplink priority, and optionally enable *sticky* uplink election by setting adjust value.

- Use **"priority VALUE"** to set priority value. A lower value increases the chance for this uplink to be elected as active uplink (lower is better). With equal path-cost (section 17.3.12), an uplink with **"priority 100"** is preferred as uplink over an uplink with **"priority 110"**.
- Use the optional **"adjust DELTA"** setting to *improve* its priority (i.e., *lower* its priority with the specified **"DELTA"**) once the uplink is elected as active uplink. This gives a *sticky* uplink behaviour where shifting active uplink will be less common.

Consider the following example with *uplink A* (**"priority 100"**), *uplink B* (**"priority 110 adjust 20"**), and *uplink C* (**"priority 120 adjust 40"**), and where *uplink A* came up first and is the active uplink. If *uplink A* goes down, *uplink B* takes over as it has lower priority than *uplink C* (110 < 120). *Uplink B* will then apply its adjustment and announce priority to 90 (110 – 20) in its *hello* messages. Uplink B will stay as active uplink even if *uplink A* comes up again (90 < 100).

"show priority" will show the configured uplink priority.

Default values priority 128 (no adjustment)

17.3.14 Set Multi-Link Dual-Homing Uplink Echo Interval

Syntax [no] echo-time <20..1000>

Context [Dual-Homing Uplink Configuration](#) context

Usage Use **"echo-time VALUE"** to set the uplink echo interval (in milliseconds) to check the integrity of the uplink.

"no echo-time" resets the configured echo interval to the default setting (200 milliseconds).

Use **"show echo-time"** to show the configured echo interval.

Default values 200 (msec)

17.3.15 Show FRNTv0 Ring Coupling Status

Syntax show coupling

Context Admin Exec context

Usage Use "show coupling" to show status of FRNTv0 Ring Coupling.

Default values Not applicable

 **Example**

```
example:/#> show coupling
===== ID 0x0101
Local uplink(s) -----
  ID  MAC                Uplink  Prio/Delta  Cost      Speed      Hello
-----
>> 7  00:07:7c:84:90:44  eth 7   128/0      200000    100-Full   100(100)ms

Global uplink(s) -----
      MAC                Uplink  Prio      Cost      Hello
-----
      00:07:7c:87:85:62  eth 7   128      200000    100(100)ms

example:/#>
```

The active uplink is marked with >>. In this case, lowest MAC address was used as tie-breaker to elect active uplink.

17.3.16 Show Multi-Link Dual-Homing Status

Syntax show dual-homing

Context Admin Exec context

Usage Use "show dual-homing" to show status of Multi-Link Dual-Homing instances.

Default values Not applicable

 **Example**

```
example:/#> show dual-homing
=====
Instance ID: 0x0001
Synchronized mode : Enabled
Local uplink(s) -----
  ID  MAC                Uplink  Prio/Delta  Cost      Speed  Sync  Pref
-----
  4   00:07:7c:10:df:00  eth 4   100/0      -         -       No   No
>> 3   00:07:7c:10:df:00  eth 3   128/0      200000    100-Full No   No
=====
Instance ID: 0x0002
Synchronized mode : Enabled
Local uplink(s) -----
  ID  MAC                Uplink  Prio/Delta  Cost      Speed  Sync  Pref
-----
  6   00:07:7c:10:df:00  eth 6   128/0      -         -       No   No
>> 5   00:07:7c:10:df:00  eth 5   128/0      200000    100-Full No   No
example:/#>
```

The active uplink is marked with >>. In this case, only one uplink was up in each of the dual-homing instances.

17.4 Feature Parameters

MAX_RING_COUPLING_INSTANCES	1
MAX_RING_COUPLING_UPLINKS	4
MAX_DUAL_HOMING_INSTANCES	8
MAX_DUAL_HOMING_UPLINKS	4

Chapter 18

Spanning Tree Protocol - RSTP and STP

The spanning tree protocol (STP) and its successor rapid spanning tree protocol (RSTP) are the standard protocols to support redundancy while avoiding broadcast storms in switched networks. WeOS supports RSTP with fall-back to STP when connecting the switch to another device only capable of STP.

STP/RSTP does not provide the same convergence performance as FRNT, however, STP/RSTP can handle arbitrary switched topologies, while FRNT operates in a *ring* structure. For information on FRNT, and coexistence between FRNT and RSTP, see [chapter 16](#).

RSTP is disabled at factory default.

18.1 Overview of RSTP/STP features

[Table 18.1](#) provides a summary of available RSTP/STP features in WeOS. Further descriptions of the spanning tree protocol and the available features are provided in [sections 18.1.1-18.1.3](#).

18.1.1 Spanning Tree Introduction

Loops in switched networks are dangerous, since packets can loop around forever and jam the network - as opposed to IP and routed networks, Ethernet frames do not include a *hop count* by which the switches could decide to drop a packet circulating around. Since a switched network may contain multiple loops, broadcast

Feature	Web	CLI	General Description
Enable STP	X	X	
Bridge priority	X	X	Section 18.1.2
Max age	X	X	Section 18.1.1
Hello time	X	X	Section 18.1.1
Forward delay	X	X	Section 18.1.1
View general RSTP/STP settings	X	X	
<u>Per Port settings</u>			
Enable STP	X	X	
Admin Edge	X	X	Section 18.1.1
Path Cost		X	Section 18.1.3
View per port RSTP/STP settings	X	X	
View RSTP/STP status	X	X	

Table 18.1: Summary of RSTP/STP features.

packets (or other packets flooded by the switches), leads to packet proliferation; this situation is generally referred to as a *broadcast storm*. On the other hand, loops in switched networks are desirable from a redundancy perspective.



Note

The purpose of the spanning tree protocol is to ensure that an arbitrary *physical* LAN topology is turned into a *logical* tree topology (i.e., loop free) in such a way that all links in the network are still connected (i.e., a *spanning tree*). This is accomplished by having the switches put some of their ports in *blocking* state.

Since loops in switched networks are so dangerous, layer-2 redundancy protocols such as STP and RSTP are very restrictive before putting a link in *forwarding* state. The main difference between STP and RSTP is that RSTP is able to react quicker to topology changes, thus can open an alternative path if a link in the active tree is broken, i.e., RSTP has shorter *convergence time* than STP. (FRNT has even faster convergence, see [chapter 16](#).)

In RSTP/STP terminology, a switch is referred to as a *bridge*. Spanning tree is a *plug-and-play* protocol - bridges can use RSTP/STP to form a tree without need for any configuration. However, the protocol provides a set of parameters which

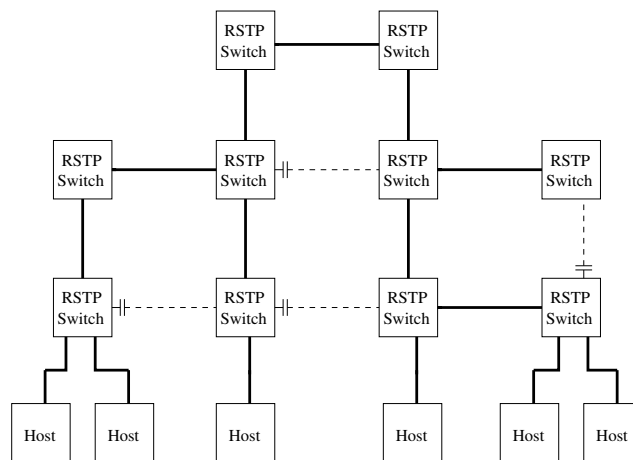

Figure 18.1: Example of RSTP creating a spanning tree. Dashed links have logically been "cut off" from the active topology by RSTP, eliminating the loops.

the operator can use to fine-tune the network setup. Below is a list of those parameters of specific interest for the WeOS RSTP/STP implementation:

- *Bridge priority*: Used for *root bridge* and *designated bridge* election. See [section 18.1.2](#).
- *Port/Path cost*: Each port is assigned a "cost". This is used by each bridge to find the *least cost* path to the *root bridge* as part of the tree establishment. See [section 18.1.3](#).
- *Max age/Hello time*: Used to detect that a STP/RSTP neighbour is down. The *max age* also puts a protocol limit to the *size of the network*¹.
- *Forward Delay*: Used when operating in STP mode (i.e., not RSTP). Defines the time period by which the protocol can be sure that STP information on a topology change has propagated from one side of the network to the other. The STP convergence time is limited by twice the forwarding delay (plus the time it takes to detect the topology change).
- *Admin Edge*: Ports where only end nodes connect are referred to as *edge ports*. If a port is only used for connecting hosts (i.e., no risk for loops), it can be configured as an *admin edge* port.

¹In RSTP the *Message Age* field in the *Hello Messages* effectively acts as a hop count, counting the distance from the Root. If the *Message Age* exceeds the *Max Age* the packet is dropped. Thus, the setting of the *Max Age* parameter restricts the size of the RSTP LAN.

i Access ports and inter-switch ports

It is recommended that all "inter-switch ports" (ports connecting switches) are configured as "non-edge ports" (admin edge disabled), and that all "access ports" (ports where hosts connect) are configured as "edge ports" (admin edge enabled).

For robustness purposes, all ports are set to "**no admin-edge**" when *spanning tree* is enabled. To improve performance on "access ports" (leading to hosts), these ports should be configured as "**admin-edge**".

When configured as *admin edge* the port will:

- be put in *FORWARDING* state quickly after system boot, and
- be kept in *FORWARDING* state during periods when the spanning tree topology is changing.

An *admin edge* assumes the port leads to a host or a router (i.e., not another bridge), and the port is therefore put in *FORWARDING* state without first verifying that the LAN is still loop free. The bridge will still send *Hello Messages* on *admin edge* ports, and will react on any incoming *Hello Messages* as it would on regular (non-"admin edge") ports. Thus, even if loops may occur via an *admin edge* port, the bridge will generally be able to receive the high-priority RSTP messages, and cut the loop by putting the appropriate port in *BLOCKING*.

The IEEE std 802.1D-2004 specifies restrictions on the *Max age* parameter with respect to the *Hello time* and the *Forward delay* as shown below. This affects how these parameters can be configured.

- $Max\ age \geq 2 * (Hello\ time + 1)$
- $Max\ age \leq 2 * (Forward\ Delay - 1)$

i Note

Some of the RSTP/STP parameters (Max age, Hello time, and Forward Delay) need to be set consistently throughout all bridges with the LAN infrastructure. Therefore, bridges inherit these parameter values from the current *root bridge*, irrespective of the corresponding parameter setting in the bridge itself.

18.1.2 Bridge Identity

Each bridge is assigned an 8 byte bridge identifier (bridge ID) as shown in [fig. 18.2](#).

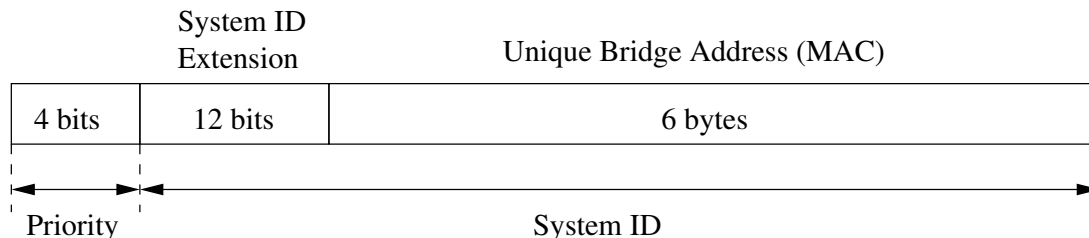

Figure 18.2: Structure of bridge ID.

The bridge ID is divided into a *priority* part (4 bits) and a *system ID* (60 bits). The bridge with the lowest bridge ID within the LAN will become the root bridge, i.e., lower *priority* means greater chance to become root bridge. The bridge ID is also used to select a *designated bridge* on a link, when multiple bridges on the link have the same "least cost path" to the root bridge.

The format of the bridge ID follows IEEE std. 802.1D-2004 (RSTP). It differs from the structure specified in IEEE std. 802.1D-1998 (STP), where the *priority* field was 2 bytes and the *system ID* field was 6 bytes. The change in structure was made with respect to the multiple spanning tree protocol (MSTP) defined in IEEE std. 802.1Q-2005 (WeOS currently does not support MSTP).

- *Priority (4 bits)*: Can take values in range 0-15, where 8 is default. 0 (zero) means highest priority and 15 lowest priority. Compared to the "old" 2 byte priority field of STP, this is rather a *priority factor* field, which can be multiplied by 4096 to get the "old" STP priority.
- *System ID Extension (12 bits)*: Set to all zeros in WeOS.
- *Unique Bridge Address*: Tie-breaker ensuring the bridge ID will be unique. WeOS uses the *base MAC address* assigned to the switch for this field.

18.1.3 Path Cost

Each port is associated with a cost referred to as a *path cost*. Low-speed links are generally given a high cost, which increases the probability of the port ending up in *blocking* state (and vice versa), in case spanning tree discovers a loop.

By default, the path cost of a port is assigned dynamically with values related to the port speed (in-line with the recommendations of IEEE std 802.1D-2004).

The same path costs are used irrespective if the port is operating in RSTP or STP mode.

Port Speed (Mbit/s)	RSTP path cost
10	2000000
100	200000
1000	20000

It is also possible to configure the path cost manually. That may be useful to get more fine grain control of which port in the LAN should be put in *blocking* state. Setting path costs manually may be desirable when operating a LAN including a mix of RSTP and STP capable, since STP uses a different set of default path costs.

18.1.4 RSTP and STP coexistence

WeOS supports both RSTP and STP, but WeOS always attempts to run RSTP on every spanning-tree enabled port. WeOS automatically shifts to STP mode on a port, if it detects a bridge running STP on that port. Other ports continue operating in RSTP mode. When operating a network including a mix of RSTP and STP bridges, it may be necessary to configure path costs manually to get the intended spanning tree behaviour, see also [section 18.1.3](#).

18.2 Managing RSTP via the web interface

18.2.1 Managing RSTP Settings

Menu path: Configuration ⇒ L2 Redundancy ⇒ RSTP

On the RSTP configuration page you will be presented to the current settings for RSTP on your switch, see below. You may change the settings by editing the page.

Rapid Spanning Tree Protocol

Enabled

Bridge Priority	<input type="text" value="8"/>	(0-15)
Maximum Age Timeout	<input type="text" value="20"/>	(6-40)
Hello Time Interval	<input type="text" value="2"/>	(1-10)
Forward Delay Timeout	<input type="text" value="15"/>	(4-30)

Port	1	2	3	4	5	6	7	8	9	10
Enabled	<input checked="" type="checkbox"/>	<input checked="" type="checkbox"/>	<input checked="" type="checkbox"/>	<input checked="" type="checkbox"/>	<input checked="" type="checkbox"/>	<input checked="" type="checkbox"/>	<input checked="" type="checkbox"/>	<input checked="" type="checkbox"/>	<input checked="" type="checkbox"/>	<input checked="" type="checkbox"/>
Admin-Edge	<input type="checkbox"/>	<input type="checkbox"/>	<input type="checkbox"/>	<input type="checkbox"/>	<input type="checkbox"/>	<input type="checkbox"/>	<input type="checkbox"/>	<input type="checkbox"/>	<input type="checkbox"/>	<input type="checkbox"/>

Enabled	Check the box to enable RSTP. If you have a JavaScript enabled browser the other settings will not be displayed unless you check this box.
Bridge Priority	A priority level used in root bridge selection. A lower value increases the probability for this switch to be elected as root bridge.
Maximum Age Timeout	The time the unit will wait before considering a neighbour designated bridge is down after the last Hello message was heard from the neighbour.
Hello Time Interval	The time between two consecutive transmissions of hello messages.
Continued on next page	

Continued from previous page	
Forward Delay Timeout	The time an interface takes to change from blocking to forwarding state. Only used when operating in STP mode.
Edge Port	<p>Ports connected to end hosts and routers (i.e., not to another switch) can be set as admin-edge ports. This avoids unnecessary BLOCKING of such ports at system startup or when a topology change occurs.</p> <p>It is <i>recommended</i> that this box is checked for every port where it is certain that only end hosts and routers connect. Ports which (may) connect to another switch should un-check this box.</p>

18.2.2 RSTP Status and Statistics

Menu path: Status ⇒ L2 Redundancy ⇒ RSTP

Spanning Tree Status and Statistics

Version	RSTP	Topology Change Count	3
		Time Since Last Topology Change	0 Days 0 Hours 0 Mins 54 Secs

Local Bridge		Root Bridge	
ID		ID	
MAC Address	00:07:7c:02:0e:61	MAC Address	00:07:7c:02:0e:61
Priority	8 (32768)	Priority	32768
Root Port	Unit is root	Max Age	20
Root Path Cost	0	Hello Time	2
		Forward Delay	15

Label	Type	Path Cost	Priority	State	Edge	Designated Bridge
Eth 1	NO-SFP	2000000	128	DISABLED	True	00:00:00:00:00:00
Eth 2	NO-SFP	2000000	128	DISABLED	True	00:00:00:00:00:00
Eth 3	10/100TX	200000	128	FORWARDING	False	00:07:7c:02:0e:61
Eth 4	10/100TX	2000000	128	DISABLED	True	00:00:00:00:00:00
Eth 5	10/100TX	2000000	128	DISABLED	True	00:00:00:00:00:00
Eth 6	10/100TX	200000	128	FORWARDING	True	00:07:7c:02:0e:61

Auto-Refresh: Off, [5s](#), [15s](#), [30s](#), [60s](#)

Refresh

Version	Always RSTP, with fallback to STP.
Topology Change Count	Number of RSTP topology changes since switch start-up.
Time Since Last Topology Change	Time since last topology change.
ID	The local and elected root bridge ID, used for root bridge and designated bridge election; consists of two parts: MAC Address The local MAC-address that is used for bridge ID. If local and root values are equal, this switch is root. Priority Priority value configured on the unit.
Continued on next page	

Continued from previous page	
Root Port	The port with the open path to the root switch. If this switch is root, the text Unit is root will be displayed.
Root Path Cost	Calculated cost to designated root switch.
Max Age	Used to detect that a STP/RSTP neighbor is down. Current value learnt from BPDUs.
Hello Time	The time between two consecutive transmissions of hello messages. Current value learnt from BPDUs.
Forward Delay	Used when operating in STP mode (i.e., not RSTP). Defines the time period by which the protocol can be sure that STP information on a topology change has propagated from one side of the network to the other. Current value learnt from BPDUs.
Auto Refresh	Click on a value to make the page reload with updated statistics automatically every 5, 15, 30 or 60 seconds. Click Off to turn off auto refresh.
Refresh	Click on this button to reload with updated statistics.

Port Status

Label	Port label, identifying the port.
Type	Type of port, e.g. Eth for ethernet.
Path Cost	Path cost associated with the port.
State	<p>FORWARDING Unit forwards packets. Normal operation.</p> <p>LEARNING The port is preparing itself for entering FORWARDING state.</p> <p>BLOCKING Unit does not forward any packets.</p> <p>DISABLED Port does not participate in operation.</p>
Edge	If TRUE the port is in admin edge mode and assumes the port leads to a host or a router (i.e., not another bridge), and the port is therefore put in FORWARDING state without first verifying that the LAN is loop free. If FRNT, the port is controlled by FRNT protocol.
Designated Bridge	The designated bridge MAC-address.

18.3 Managing RSTP via the CLI

Command	Default	Section
<u>Spanning Tree Configuration</u>		
[no] spanning-tree	Disabled	Section 18.3.1
priority <0-15 0-65536>	8 (32768)	Section 18.3.2
max-age-time <6-40>	20	Section 18.3.3
hello-time <1-10>	2	Section 18.3.4
forward-delay <4-30>	15	Section 18.3.5
stp-port <PORTLIST all>		Section 18.3.6
[no] enable	Enabled	Section 18.3.7
[no] admin-edge	Disabled	Section 18.3.8
[no] path-cost <0-20000000>	0 (Auto)	Section 18.3.9
<u>Spanning Tree Status</u>		
show spanning-tree		Section 18.3.10

18.3.1 Manage RSTP

Syntax [no] spanning-tree

Context [Global Configuration](#) context

Usage Enter Spanning Tree Configuration context, and activate spanning-tree (if not already activated). Use **"no spanning-tree"** to disable spanning-tree and to remove spanning-tree configurations.

Use **"show spanning-tree"** to view general spanning-tree settings, given that spanning-tree is enabled (also available as **"show"** command within the Spanning Tree Configuration context).

Default values Disabled

18.3.2 Bridge Priority Setting

Syntax priority <0-15|0-65535>

Context [Spanning Tree Configuration](#) context

Usage Set bridge priority, where a low value means high priority, which increase the probability of being elected as *root bridge*. Values can be entered in

two ways, either in range 0-15, which corresponds to the 4-bit priority field specified in IEEE std 802.1D-2004, or in range 16-65535 which corresponds to the traditional 2 byte priority field defined in IEEE 802.1D-1998. In the latter case, the value is divided by 4096, and stored as a value 0-15. See [section 18.1.2](#) for more information.

"no priority" resets the bridge priority to the default setting.

Use **"show priority"** to view the current bridge priority setting.

Default values 8 (32768)

18.3.3 Max Age Setting

Syntax max-age-time <6-40>

Context [Spanning Tree Configuration](#) context

Usage Set spanning-tree max age timeout. Since bridges use the max age configured at the root bridge, this parameter setting only matters if this bridge becomes the root bridge.

"no max-age-time" resets the max age timeout to the default setting.

Use **"show max-age-timeout"** to view the current max age timeout setting.

Default values 20

Error messages An error message is given if the **"max-age-time"** is not given a valid value with respect to **"hello-time"** or **"forward-delay"**, see [section 18.1.1](#).

18.3.4 Hello Interval

Syntax hello-time <1-10>

Context [Spanning Tree Configuration](#) context

Usage Set spanning-tree hello time interval. Since bridges use the hello time configured at the root bridge, this parameter setting only matters if this bridge becomes the root bridge.

"no hello-time" resets the hello time to the default setting.

Use **"show hello-time"** to view the current hello time setting.

Default values 2 (seconds)

Error messages An error message is given if the **"hello-time"** is not given a valid value with respect to **"max-age-time"**, see [section 18.1.1](#).

18.3.5 Forward Delay

Syntax forward-delay <4-30>

Context [Spanning Tree Configuration](#) context

Usage Set spanning-tree forward delay. Since bridges use the forward delay configured at the root bridge, this parameter setting only matters if this bridge becomes the root bridge.

"no forward-delay" resets the forward delay to the default setting.

Use **"show forward-delay"** to view the current forward delay setting.

Default values 15 (seconds)

Error messages An error message is given if the **"forward-delay"** is not given a valid value with respect to **"max-age-time"**, see [section 18.1.1](#).

18.3.6 Manage RSTP Ports

Syntax [no] stp-port <PORTLIST|all>

Context [Spanning Tree Configuration](#) context

Usage Enter Spanning Tree Port Configuration context to manage per port spanning-tree settings for one or more ports.

"no stp-port <PORTLIST|all>" (e.g., **"no stp-port all"**) will disable spanning tree for the specified ports.

Use **"show stp-port <PORTLIST|all>"** to view the spanning tree settings for the specified port(s).

Default values Not applicable.

 **Example**

```
example:/config/spanning-tree/#> show stp-port all
Port      Enabled  Admin-Edge  Path-cost
-----
Eth 1     YES      NO           AUTO
Eth 2     YES      NO           AUTO
Eth 3     YES      YES          AUTO
Eth 4     YES      YES          AUTO
```

```
Agg A1  YES    YES    20000
Agg A2  NO     NO     AUTO
example:/config/spanning-tree/#>
```

18.3.7 Enable Spanning Tree on a Port

Syntax [no] enable

Context [Spanning Tree Port Configuration](#) context

Usage Enable the spanning tree protocol on a port. Use **"no enable"** to disable spanning tree protocol on a port.

Default values Enabled

18.3.8 Admin Edge Setting

Syntax [no] admin-edge

Context [Spanning Tree Port Configuration](#) context

Usage Configure the port as an *access port* (**"admin-edge"**), or as an *inter-switch port* (**"no admin-edge"**).

Note

It is *recommended* that every port where it is certain that only end hosts and routers connect (but **not** switches/bridges) are configured as **"admin-edge"**. Port which (may) connect to **another switch/bridge** should be configured as **"no admin-edge"**.

Use **"show admin-edge"** to view the admin edge setting for this port.

Default values Disabled (**"no admin-edge"**)

18.3.9 Path Cost Setting

Syntax [no] path-cost <0-200000000>

Context [Spanning Tree Port Configuration](#) context

Usage Configure the spanning tree path cost for a port. A low speed link should get a higher cost, a high speed link a lower cost. Use **"path-cost 0"** (or

"no path-cost") to have the path-cost assigned automatically depending on the port speed (see [section 18.1.3](#)).

Values in range 1-20000000 means a statically configured path cost of the given value.

Use **"show path-cost"** to view the path cost setting for this port.

Default values Automatic (**"path-cost 0"**)

18.3.10 Show RSTP Status

Syntax show spanning-tree

Context [Admin](#) [Exec](#) context.

Usage Show spanning-tree status information, including current port states, root bridge ID, etc..

Default values Not applicable.

Chapter 19

Media Redundancy Protocol

This chapter describes WeOS support for the Media Redundancy Protocol (MRP). MRP is specified in IEC 62439-2[19], and just like FRNT ([chapter 16](#)), MRP is designed to handle redundancy in switched ring topologies.

MRP support in WeOS requires the product to have an MRP license installed, see [section 7.1.9](#).

19.1 Overview of the MRP protocol and its features

Feature	Web	CLI	General Description
MRP Mode (Manager/Client)	X	X	Section 19.1.1
Define Ring Ports	X	X	Section 19.1.2
VLAN Encapsulation	X	X	Section 19.1.3
Link React	X	X	Section 19.1.4
Ring Open Detect	X	X	Section 19.1.5
MRP and Routing			Section 19.1.6
MRP and Upgrading			Section 19.1.7

19.1.1 MRP introduction

MRP is a protocol to handle redundancy in ring topologies. When the ring is intact (closed), the Media Redundancy Manager (MRM) will put one of its two ring ports, its *secondary* port, in BLOCKING mode.

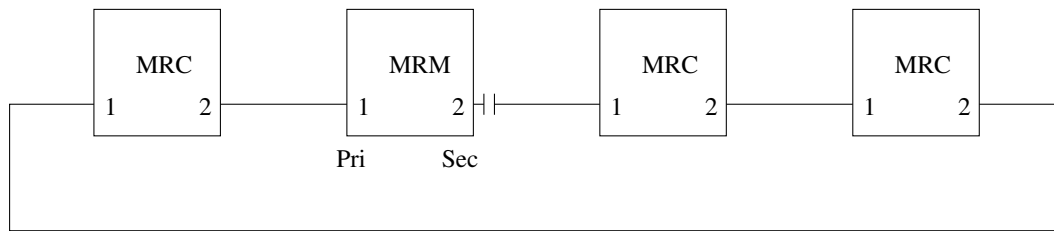

Figure 19.1: When MRP ring is closed, the MRM (manager) will put its *secondary* port BLOCKING.

If a link or node in the ring topology goes down, the MRM will determine the ring as broken (open) and put its *secondary* port in FORWARDING mode. In MRP, the first ring port coming up on the MRM will be denoted *primary* and the other *secondary*. If the primary port goes down, the other MRM port will become primary, i.e., the roles can change dynamically depending on the link state.

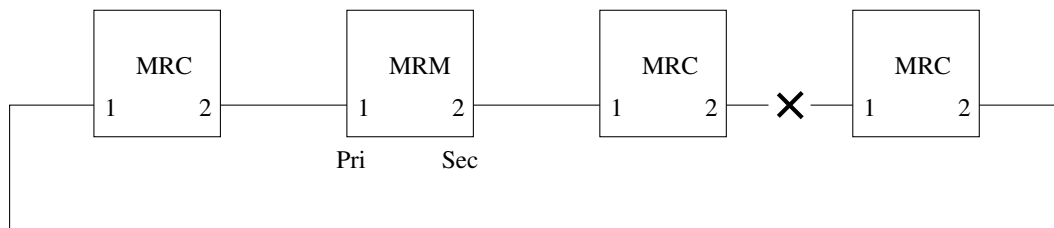

Figure 19.2: When MRP ring is open/broken, the MRM (manager) will put its *secondary* port in FORWARDING state.

A WeOS unit with MRP license installed is capable of acting as MRM (manager) or MRC (client) with the MRP 30 ms or 200 ms recovery time profile. As of WeOS v4.33.0, the MRP implementation has the following characteristics:

- No automanager election (MRA): Automanager election is **not** supported. That is, there should be one and only one MRM configured in the ring. Other MRP nodes in the ring should be configured as MRCs.
- No CFM on ring ports: Connectivity Fault Management (CFM) for MRP ring ports is **not** supported.
- Single MRP instance An MRP node can only be configured as part of one MRP ring.
- Assumes MRCs capable of BLOCKING: A WeOS MRM node assumes MRCs are capable of BLOCKING their MRP ports. Thus, interoperability is not supported

with MRP implementations where MRCs are unable to block their ring ports.

Although it possible to run MRP and other layer-2 redundancy protocols as FRNT ([chapter 16](#)) and RSTP ([chapter 18](#)), such usage implies topology restrictions. See [section 16.2](#) for more information.

19.1.2 Guidelines when selecting MRP ports

MRP handles redundancy in switched ring topologies. The ports selected as ring ports should be Ethernet ports. As required by the MRP standard[19], full duplex Ethernet links of 100 Mbit/s or higher speed is assumed.

When configuring MRP in slot based WeOS products (see [section 10.1.1](#)) both ring ports must reside in the same slot. Similar restrictions apply to WeOS Viper, RedFox Rail (RFR) and RedFox Industrial Rack (RFIR) products.

It is **not** possible to use a link aggregate ([chapter 20](#)) as an MRP port. SHDSL ports cannot be used as MRP ports.

19.1.3 VLAN encapsulation of MRP frames

By default, MRP signalling frames are sent *without* IEEE 802.1Q VLAN tags. The WeOS MRP implementation supports assigning a specific VLAN for MRP signalling. The same VLAN ID should then be configured on all MRP nodes in the ring.

Example

```
example:/#> configure
example:/config/#> mrp
example:/config/mrp-1/#> vid 33
```

19.1.4 React on Link Change

When an MRC detects link down, it will send an MRP Link-Down message to inform the MRM. With *react-on-link-change* enabled on the MRM, an MRM with a ring in *closed* state will immediately set its BLOCKED port in FORWARDING state when receiving a Link-Down message.

With *react-on-link-change* disabled on the MRM, it will ignore Link-Down messages and instead rely its mechanism of sending and monitoring of MRP Test messages to determine whether the ring is closed or open.

In WeOS the *react-on-link-change* behaviour is configurable and it is enabled by default. Only managers can have this option configured, thus this is not available as configuration option in client mode.

19.1.5 Ring Open Detection Mode

WeOS offers the ability to fine tune the criteria when the MRM determines the ring as broken. The following two modes are available:

- *conservative*: Determine ring open (broken) when failing to receive MRP_Test packets on primary AND secondary ring port.
- *standard*: Determine ring open (broken) when failing to receive MRP_Test packets on primary OR secondary ring port.

When the MRM determines the ring to be open (broken), it will set its secondary port to Forwarding mode. The *standard* mandates the MRM to determine the ring as open when failing to receive MRP_Test packets in one direction, i.e., not receiving MRP_Test packets on its primary OR secondary port. This speeds up failover when a ring becomes broken, but may cause a forwarding loop (storm) in case of *one-way transmission errors*¹. With the *conservative* setting, the MRM will determine the ring to be open first when MRP_Test packets in both directions fail. The default mode for WeOS MRM is *conservative*.

19.1.6 MRP and Routing

MRP is a function to support redundancy at layer-2 (switching). This improves capacity and failover performance compared to layer-3 (routing) mechanisms such as OSPF (chapter 29). Nevertheless, routing techniques have good scalability characteristics as the network is segmented into different broadcast domains.

Although technically feasible, it is *strongly recommend* to separate MRP and routing, localising the distinct functions in dedicated WeOS units.

¹One-way transmission error means that data can be forwarded in one direction, but not the other. One example is when only one fiber in a fiber pair works.

Note

In some cases using MRP nodes as routers makes sense. To ensure correct operation of the MRP node, the CPU bandwidth is reduced by default, i.e., when "**cpu-bandwidth-limit**" is set to "**auto**" ([section 8.3.6](#)) on a WeOS unit configured for MRP. This in turn reduces routing performance.

This automatic reduction of CPU bandwidth can be overridden by changing the CPU bandwidth limit setting ([section 8.3.6](#)).

19.1.7 Recommendations when upgrading units in an MRP ring

Upgrading units in an MRP ring can be done in different ways. Here a structured method is described, where nodes are upgraded sequentially. The objectives are determinism and simplicity rather than optimal connectivity during upgrade or minimal upgrade time.

Note

The method assumes the MRP ring is **not** used as operational network during the upgrade procedure. Some nodes will temporarily be inaccessible when other nodes are upgrading/rebooting.

The method assumes an *upgrade management PC* is used, holding the new WeOS image. The image can either be *uploaded* to the WeOS unit from the Web interface ([section 7.2.1.1](#)), or one can login to WeOS unit from the PC (Web or SSH/CLI) and upgrade using file *download* from the PC ([section 7.2.1.2](#) or [7.3.1](#)). The latter method requires the upgrade management PC to run a TFTP or FTP server.

1. Determine where the upgrade management PC connects to the ring. It could either be directly connected to one of the MRP units, or connect remotely via an intermediate switch or a router. In [fig. 19.3a](#)), the PC connects via switch #6, which happens to be an MRP client (MRC).
2. Disable one of the MRP ports on switch #6 (here port 1). The MRM will detect the broken ring and set its backup port in forwarding mode. This step turns the ring into a bus. See [fig. 19.3b](#)).
3. Upgrade the unit farthest away from #6 (here unit #7). Upgrade is done with Web Upload or TFTP/FTP download from the management PC.

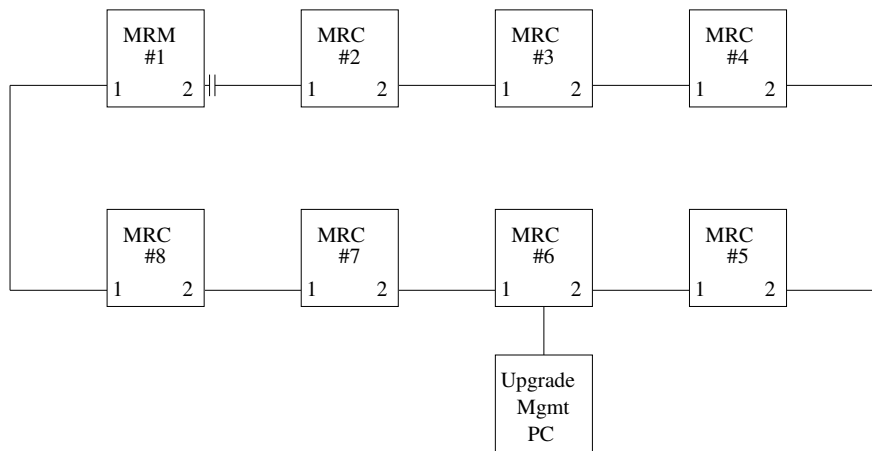

a) MRP Ring with Upgrade Management PC connected to one MRP node (#6)

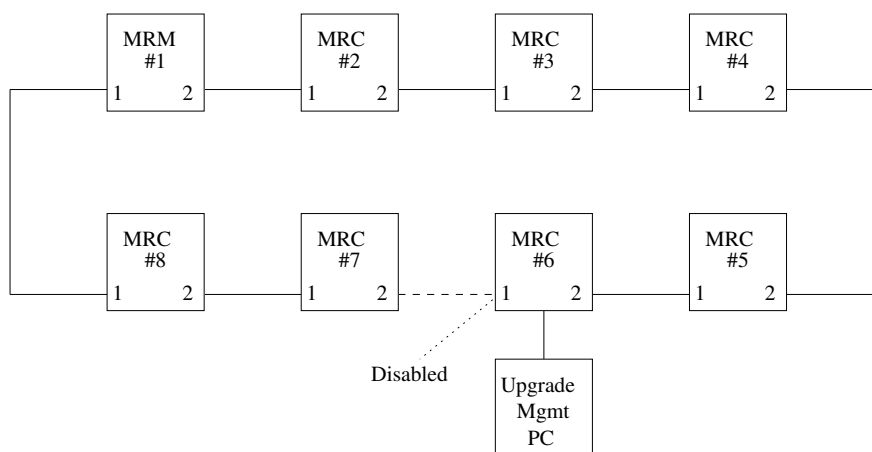

b) Disabling one MRP ring port on switch "#6" before starting the upgrade procedure

Figure 19.3: Upgrading WeOS nodes in an MRP ring.

4. When unit #7 is upgraded successfully, continue sequentially with unit #8, then #1, and so on. At last, upgrade the unit where the management PC connects (#6).
5. After unit #6 has been upgraded successfully, (re)enable port 1 on unit #6. The MRP ring is now upgraded.

19.2 Managing MRP settings via the web interface

19.2.1 Overview of MRP settings

Menu path: Configuration⇒L2 Redundancy⇒MRP

(This path is only available if a valid MRP license is installed, see [section 7.1.9.](#))

On the MRP configuration page you will be presented to an overview of the current settings for MRP on your switch, see below.

MRP

Id	Enabled	Mode	Port 1	Port 2	
1		Manager	Eth-4	Eth-6	

Id	MRP Instance Id. (As of WeOS v4.33.0, only one instance is supported.)
Enabled	Enable/disable setting of this instance.
Mode	MRP mode: Manager (MRM) or Client (MRC).
Port 1/ Port 2	MRP ring port 1 and port 2.
Edit	Click this icon to edit an MRP instance.
Delete	Click this icon to remove an MRP instance.

If no MRP instance is configured you may create one by clicking the **New** button. When editing a new or existing instance the page below is displayed.

Edit MRP Instance

Id	1
Enabled	<input checked="" type="checkbox"/>
Mode	Manager ▾
Port 1	4 ▾
Port 2	6 ▾
VLAN ID	Disabled ▾
Profile	200 ms ▾
React On Link Change	<input checked="" type="checkbox"/>
Ring Open Detect	Conservative ▾

Id	MRP Instance Id. (As of WeOS v4.33.0, only one instance is supported.)
Enabled	Enable/disable this instance.
Mode	Select MRP mode: Manager (MRM) or Client (MRC).
Port 1/ Port 2	Set MRP ring port 1 and port 2. See section 19.1.2 for guidelines on MRP port selection.
VLAN ID	Enable/disable VLAN encapsulation of MRP messages. When enabled, set associated VLAN ID.
Profile	Set reconfiguration time profile (200 or 30 ms).
React On Link Change	Enable/disable React on Link Change setting. (<i>manager</i> only)
Ring Open Detect	Select Ring Open Detect mode: Conservative or Standard (<i>manager</i> only).

19.2.2 View MRP Status

Menu path: Status ⇒ L2 Redundancy ⇒ MRP

On this page MRP status is presented.

MRP Status							
Ring	Enabled	VLAN ID	Mode	Status	React On LC	Port Primary	Port Secondary
1	✓	Disabled	Manager	Closed	✓	Eth 4	Eth 6

Auto-Refresh: Off, [5s](#), [15s](#), [30s](#), [60s](#)

[Refresh](#)

Id	Instance ID for the MRP ring.
Enabled	Indication if the ring is enabled or not.
VLAN ID	VLAN encapsulation of MRP messages. When enabled, the associated VLAN ID is shown.
Mode	Manager (MRM) or Client (MRC).
Status	Ring status: Closed (Ring OK), Open (Ring Broken; MRM present in segment) or Unknown (Ring Broken; MRM not present in segment).
Port Primary/ Secondary	(Only relevant on Manager.) Port designated as <i>Primary</i> and <i>Secondary</i> respectively. When the Ring is Closed (OK), the Manager will put its Secondary port in BLOCKING state.
Auto Refresh	Click on a value to make the page reload with updated statistics automatically every 5, 15, 30 or 60 seconds. Click Off to turn off auto refresh.
Refresh	Click on this button to reload with updated status.

19.3 Managing MRP settings via the CLI

Command	Default	Section
<u>Configure MRP settings</u>		
[no] mrp [ID]		Section 19.3.1
[no] enable	Enabled	Section 19.3.2
[no] manager	Client	Section 19.3.3
[no] profile <30 200>	200	Section 19.3.4
ring-ports <PORT-1, PORT-2>		Section 19.3.5
[no] vid <1-4095>	Disabled	Section 19.3.6
[no] link-react	Enabled	Section 19.3.7
[no] ring-open-detect <conservative standard>	Conservative	Section 19.3.8
<u>Show MRP status</u>		
show mrp		Section 19.3.9

19.3.1 Managing MRP

Syntax [no] mrp [ID]

Context [Global Configuration](#) context

Usage Enter MRP Configuration context of the given MRP instance ID. Currently only a single MRP instance is supported.

The MRP instance is only activated upon the selection of valid MRP ring ports and enable setting, see [sections 19.3.5](#) and [19.3.2](#).

Use **"no mrp [ID]"** to remove an existing MRP instance.

Use **"show mrp"** to list configured MRP settings (also available as **"show"** command within the MRP Configuration context).

Default values Default ID is 1

19.3.2 Enable/Disable an MRP instance

Syntax [no] enable

Context [MRP Configuration](#) context

Usage Enable or disable an MRP instance. Use **"enable"** to enable the MRP instance, and **"no enable"** to disable the MRP instance (without losing configuration settings for this instance).

Use **"show enable"** to show whether the MRP instance is enabled or disabled.

Default values Enabled

19.3.3 MRP manager and client switch

Syntax [no] manager

Context [MRP Configuration](#) context

Usage Configure device to act as MRP manager (MRM) or MRP client (MRC) for this MRP instance. Use **"manager"** to configure the device to act as a *manager* and, and **"[no] manager"** to configure the device as *client* switch.

Use **"show manager"** to show whether the unit is configured as manager or client switch

Default values Client ("**no manager**")

19.3.4 MRP Profile

Syntax [no] profile <30|200>

Context [MRP Configuration](#) context

Usage Configure device to use (max reconfiguration time) profile of 30 or 200 ms. Use **"profile 200"** to configure the device as *200 ms* profile, and **"profile 30"** for the *30 ms* profile.

"no profile" will reset the profile to default (200).

"show profile" to show whether the unit is configured as 30 ms or 200 ms profile.

Default values 200 (ms)

19.3.5 MRP Ring Ports

Syntax ring-ports <PORT-1, PORT-2>

Context [MRP Configuration](#) context

Usage Set the physical ports (Ethernet ports) to use as MRP ring ports.

In normal operation, the MRP manager toggles between primary or secondary port and keep secondary blocked when the ring is closed (intact). That is, if the primary port goes down, then the secondary becomes primary.

 **Note**

| For restrictions on how to select MRP ports, see [section 19.1.2](#).

Use "**show ring-ports**" to show configured MRP ring ports.

Default values Not applicable

Example

```
example:/#> configure
example:/config/#> mrp
Activating MRP with default settings, remember to change the ring ports!
Invalid settings: No ring ports defined
example:/config/mrp-1/#> ring-ports 4,6
example:/config/mrp-1/#> manager
example:/config/mrp-1/#> show
MRP ring#           : 1
Enabled              : Yes
Mode                 : Manager
Ring ports           : 4,6
Profile mode         : 200 msec
VLAN ID              : Disabled
React On LC          : On
Ring Open Detect     : Conservative
example:/config/mrp-1/#> leave
Starting Media Redundancy Protocol ..... [ OK ]
Configuration activated. Remember "copy run start" to save to flash (NVRAM).
example:/#> cp run start
```

19.3.6 MRP VLAN encapsulation

Syntax [no] vid <1-4095>

Context [MRP Configuration](#) context

Usage Enable/disable VLAN encapsulation of MRP signalling. When enabled, the MRP messages are tagged with the given VLAN ID, e.g., use "**vid 11**" to let MRP messages be tagged with VLAN ID 11.

Use "**no vid**" to disable VLAN encapsulation of MRP messages. Use "**show vid**" to show the configured VLAN encapsulation setting.

Default values Disabled ("**no vid**")

19.3.7 MRP React-On-Link-Change

Syntax [no] link-react

Context [MRP Configuration](#) context (*manager* only)

Usage Enable/disable MRP react-on-link-change. When enabled on a manager (MRM), the manager will immediately put its BLOCKED port in FORWARDING state upon receiving an MRP Link-Down message from a client.

Use **"link-react"** to enable and **"no link-react"** to disable "react-on-linkchange".

Use **"show link-react"** to show the configured setting.

Default values Enabled

19.3.8 MRP Ring Open Detect

Syntax [no] ring-open-detect <conservative|standard>

Context MRP Configuration context (*manager* only)

Usage Configure the mode ("**conservative**" or "**standard**" used by the MRM to determine the ring to be open (broken).

Use **"show ring-open-detect"** to show the configured setting.

Default values Conservative

19.3.9 Show MRP ring status

Syntax show mrp

Context Admin Exec context.

Usage Show status of configured MRP rings. This will provide information regarding:

- MRP Ring Status:
 - **Closed:** This means that the ring is "intact" (OK),
 - **Open:** This means that the ring is "broken", but that there is an MRM present in this segment.
 - **Unknown:** This means that the ring is "broken", without any MRM on this segment. The "Unknown" state can only be shown by an MRC, not an MRM.
- Port State of the local MRP ports (FORWARDING/BLOCKING).

Default values Not applicable.

Example

```
example:/#> show mrp
Instance#           : 1
Enabled             : Yes, running as PID 981
Role                : MRM
Ring                : Closed
Profile             : 200ms
Port-1              : Eth 4
Port-2              : Eth 6
VLAN ID             : Disabled
React on link change : Enabled
Transitions         : 1
Last topology change : 0 d, 5 h, 53 m, 5 s
Ring Open Detect    : Conservative

Primary port        : Eth 6 (FORWARDING)
Secondary port      : Eth 4 (BLOCKING)

MRM source: 02:07:7c:06:e2:20
example:/#>
```

Chapter 20

Link Aggregation

This chapter covers WeOS support for link aggregation (IEEE 802.3ad/802.1AX[21]). With link aggregation, two or more Ethernet links can be bundled and treated as a single MAC entity by the upper layer protocols. The primary use is to achieve *redundancy* in layer-2 bus topologies. A coarse form of load balancing is also provided, but only if different traffic flows are mapped to different aggregate member links.

WeOS supports the standard Link Aggregation Control Protocol (LACP[21]) for aggregation control, but also *static* aggregation control, where the active set of member links is solely determined based on their link up/down state.

20.1 Link Aggregation Support in WeOS

Feature	Web	CLI	General Description
Enable/Disable Aggregate	X	X	Section 20.1.1
Define Member Ports	X	X	-"
Static Aggregation Control	X	X	Section 20.1.2
LACP Aggregation Control	X	X	Section 20.1.3
Timeout (Short/Long)	X	X	-"
Active/Passive	X	X	-"
Show Link Aggregate Status			

20.1.1 Introduction to Link Aggregation

Link aggregation enables physical links to be bundled together to form a single logical link, an *aggregated link*, see fig. 20.1. Upper layer protocols will treat the aggregate as a single MAC entity, i.e., as one Ethernet port with its own label, a MAC address assigned, and so on. In WeOS, aggregates are named "a0", "a1", etc., and inherit their MAC address from one of their member ports.

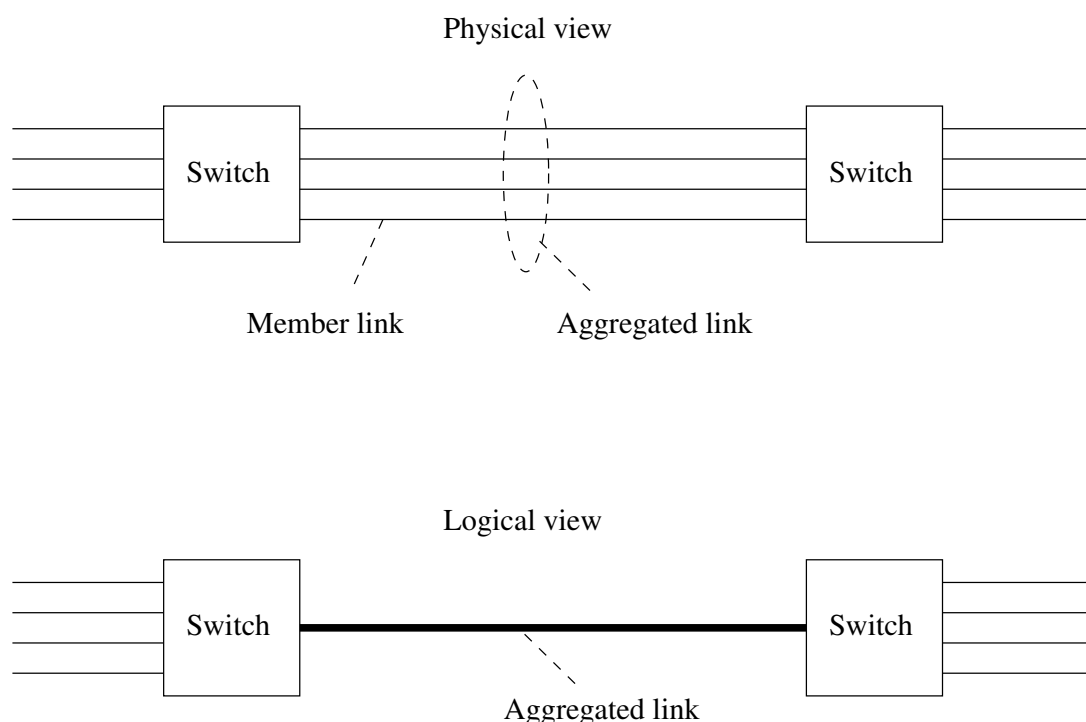

Figure 20.1: Example of link aggregation with four member links

All member ports in an aggregate are able to forward data. However, the IEEE802.1AX standard[21] mandates the aggregate to deliver packets *in order per data flow* to avoid problems for upper layer protocols. This means the switch will send all traffic of an individual *data flow* through the same member link. Other *flows* may be sent through other member links. The effectiveness of this *load balancing* depends on several factors:

- The granularity by which the switch can distinguish between different traffic flows: WeOS units determine packet flow based on the combination of the

source and destination MAC address of the packet¹ (done in hardware).

- *The distribution of traffic flows:* If there are *many* flows (and if they are of *equal load*) the ability to load balance improves. This depends on the traffic patterns in your network. Avoiding patterns where all traffic end up with the same source and destination MAC over the aggregate improves the ability to load balance².
- *The mapping of traffic flows to different member links:* WeOS units map traffic flows to different (active) member links in a *static* way. This mapping aims to equalise the number of flows mapped to each member link, but its effectiveness is limited when the number of flows are low.



Note

To summarise, link aggregation should generally be used as a means to achieve **redundancy** in bus topologies. It may be used to increase data capacity, however, the ability to load balance between the member links is limited and depends on the use case.

When an aggregate is configured in WeOS, the following restrictions apply:

- *Ethernet as member ports:* Only aggregation of Ethernet ports is supported.
- *Member ports explicitly associated with aggregate:* For a port to be part of an aggregate, it must explicitly be associated with that aggregate.
- *Maximum 8 aggregates:* At most 8 aggregates can be configured on a WeOS unit.
- *Maximum 8 member ports per aggregate:* Each aggregate can have at most 8 member ports.
- *Member ports in same slot:* In slot based WeOS products (see [section 10.1.1](#)) all member ports must reside in the same slot as of WeOS v4.33.0. Similar restrictions apply to WeOS Viper, RedFox Rail (RFR) and RedFox Industrial Rack (RFIR) products.

¹The algorithm to determine flow uses a hash function applied to the packet's source and destination MAC address.

²*Switching* traffic over the link aggregate may improve load balancing as opposed to *routing* (routers typically use the same source and destination MAC for all unicast traffic). Multicast flows commonly utilise different destination MACs irrespective if the WeOS units are switching or routing, thus has good load balancing properties.

A aggregate has state *Down* when all its member ports have state *Down*, and the aggregate is *Up* when at least one of its member ports has state *Up*.

The next subsections provide additional information on WeOS support for link aggregates: [sections 20.1.2](#) (static) and [20.1.3](#) (LACP) contain information on the methods to control link aggregates in WeOS, while [section 20.1.4](#) include more details on using link aggregates in various low-layer features in WeOS.

20.1.2 Static Link Aggregates

For static link aggregates the including member ports are the only settings that have to be specified in the configuration. The members in an aggregate do not need to have the same speed settings, although that is the preferred setting (otherwise the capacity of the aggregate will be unbalanced).

Ports that are included in an aggregate and have link up will be qualified as active ports, and the network traffic will be sent on those links. If a link goes down or up in the aggregate the network traffic will be distributed over the new set of active links. Because an active link in an aggregate is qualified on the link status **no media converters** are allowed between statically aggregated ports. Below is a CLI configuration example where the static link aggregate a1 is configured with member ports 3 and 7 on a WeOS switch.

Example

```
example:/#> configure
example:/config/#> aggregate a1
example:/config/aggregate-a1/#> ports 3,7
example:/config/aggregate-a1/#> type static
example:/config/aggregate-a1/#> show
Name          : a1
Status        : Enabled
Type          : static
Ports         : 3,7
example:/config/aggregate-a1/#> end
example:/config/#>
```

20.1.3 LACP Controlled Link Aggregates

The Link Aggregation Control Protocol (IEEE 802.3ad/802.1AX [\[21\]](#)) is a standard method for aggregating member links that have the same speed and duplex mode. The primary advantage over static link aggregation is the ability to confirm that the remote partner can handle aggregation. It is also possible to handle failover when media converters are present.

LACP relies upon periodic transmission of information and state between the switches. The protocol messages (LACP-PDUs) are sent by the first party (the Actor) to the second party (the Actor's protocol Partner) with information about what the Actor knows, both about its own state and that of the Partner.

Switches can be configured to *active* or *passive* participation in LACP. Passive LACP indicates the preference for not transmitting LACP-PDUs unless its Partner is Active LACP, i.e. it does not generate any LACP traffic by its own. Active LACP indicates the preference to participate in the protocol regardless of the Partner setting, i.e. it always generates LACP traffic.

LACP-PDUs are transmitted periodically when either the Actor or the Partner is configured with Active LACP. These transmissions will occur at either a *fast* or *slow* transmission rate depending upon the timeout setting (*short* or *long* timeout) of the Partner system.

The LACP state is determined by the contents of the LACP-PDUs and can be in any of the following states:

Detached The port is being detached from the aggregator.

Waiting The port is being attached to the aggregator.

Attached The port is attached to the selected aggregator.

Collecting Indicates that the receive function of this link is enabled.

Distributing Indicates that the transmit function of this link is enabled.

The switch will set a member port in forwarding state when LACP state is Distributing. For all other LACP states the port state will be blocking³. The aggregate is in forwarding state as long as at least one member port is in forwarding state. Also, the aggregate will be up as long as at least one member port is up.

WeOS assumes that the configured aggregate connects two switches. If the aggregate member ports on one switch is connected to several other switches LACP will only include member ports to one of the neighbours in the active port set:

- Ports to the neighbour with the highest total bandwidth will be selected.
- If several aggregates share the same bandwidth, then the aggregate is selected based on LACP *system priority*, *system identifier*, *port priority*, and *operational key*.

³If RSTP or FRNT are run over the aggregate, those protocols may also decide to set the ports in blocking state.

In WeOS v4.33.0, the LACP system priority is set to *0x8000* (hex), system identifier is set to the *MAC address of the first member port* of the aggregate, the port priority is set to *0x8000* (hex), and the operational key is set to the configured *aggregate identifier* (see [sections 20.2](#) and [20.3](#)). More information about aggregate selection can be found in IEEE 802.3ad/802.1AX [21].

20.1.4 Link Aggregates and Low layer protocols

20.1.4.1 Link Aggregation and VLAN

Ethernet and DSL ports on WeOS units are associated (*untagged* or *tagged*) with one or more VLANs as described in [chapter 15](#). Link aggregates can **not** be mapped directly to VLANs. Instead the user must add each of the aggregate member ports to the intended VLAN(s).

For the setup in [fig. 20.2](#), the physical ports 1-4 are mapped tagged ("**tagged 1-4**") to VLANs 1&2 rather than the aggregates (i.e., "**tagged a1,a2**" is not possible as of WeOS v4.33.0). An extract of the configuration file is shown below.

 **Example**

```

vlan 1
    name vlan1
    untagged 5-7
    tagged 1-4
end

vlan 2
    name vlan2
    untagged 8-10
    tagged 1-4
end

```

20.1.4.2 Link Aggregation and Link Alarms

As described in [section 25.1](#) the operational state (Up/Down) of Ethernet and DSL ports can be used as alarm triggers, i.e., *link alarms*. When a port is a member of a link aggregate, it is still possible to define link alarms for the individual member ports. It is also possible to create link alarms for the aggregates.

Below is a CLI configuration example where a link alarm is configured for aggregate *a1*. The aggregate has state *Down* when all its member ports has state *Down*, and the aggregate is *Up* when at least one of its member ports has state *Up*.

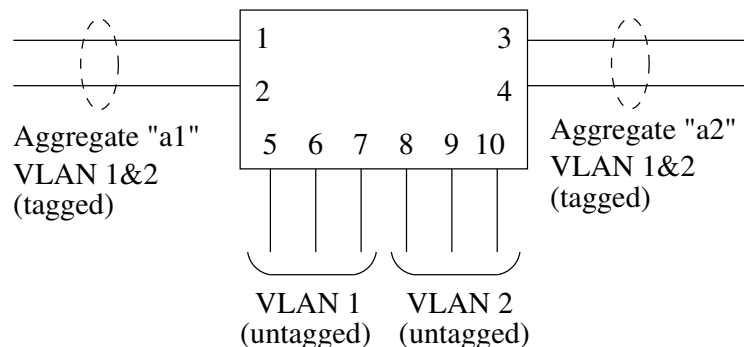

Figure 20.2: The physical ports 1-4 rather than the logical aggregates (*a1* and *a2*) are associated with the VLANs (VLAN 1 and 2).

Example

```
example:/#> configure
example:/config/#> alarm
example:/config/alarm/#> trigger link-alarm
example:/config/alarm/trigger-2/#> port a1
example:/config/alarm/trigger-2/#> end
example:/config/alarm/#>
```

20.1.4.3 Link Aggregation and unicast/multicast MAC learning

The MAC forwarding database (FDB, see [section 15.1.8](#)) holds information on where to forward *known* MAC addresses. Unicast addresses are learnt dynamically by looking at the source MAC of incoming packets, while multicast addresses are typically learnt dynamically via IGMP snooping ([chapter 21](#)), or entered manually⁴ by the operator.

When a (unicast/multicast) MAC address is learnt dynamically on a member port of a link aggregate, all ports of the aggregate are added to the MAC address' FDB entry, since the link aggregation flow distribution mechanism can map traffic to the MAC address on any member port.

In the example below, aggregate *a1* consists of member ports 5 and 6, and IGMP snooping is enabled on the VLAN the ports are associated with. An IGMP report has been received for IP multicast address 225.1.2.3 (MAC 01:00:5e:01:02:03) on one of the member ports and both ports are added to the *forwarding database* for that MAC address.

⁴See [section 15.4.3](#) for CLI command to enter MAC forwarding database entries manually.

Example

```
example:/#> sh ip igmp
VID Querier IP      Querier MAC      Port Interval Timeout
-----
  1 192.168.2.200    LOCAL
-----
VID Multicast Group Filtered MAC Addr Active ports
-----
  1 225.1.2.3        01:00:5E:01:02:03 a1
-----
Total: 1 filters, max 1200, in 1 VLAN.

example:/#> sh fdb
MAC          VLAN State      Port(s)
=====
...
01:00:5e:01:02:03 ANY IGMP      5-6
...
=====
FDB Aging time: 300 sec.
example:/#>
```

Similarly, traffic from unicast address *00:07:7c:00:02:61* has come in on one member port, thus both member ports are automatically added to the MAC's FDB entry.

Example

```
example:/#> sh fdb
MAC                VLAN  State      Port(s)
=====
...
00:07:7c:00:02:61  ANY  294 s      5-6
...
=====
FDB Aging time: 300 sec.
example:/#>
```

When adding (multicast) MAC addresses statically to the MAC FDB, each of the individual member ports needs to be specified. Thus, in the example below, with ports 5 and 6 belonging to aggregate *a1*, the command **"mac 01:00:5e:00:11:22 port 5,6"** is used (while **"mac 01:00:5e:00:11:22 port a1"** would not work as of WeOS v4.33.0).

Example

```
example:/#>
example:/#> configure
example:/config/#> fdb
example:/config/fdb/#> mac 01:00:5e:00:11:22 port 5,6
example:/config/fdb/#> end
```

20.1.4.4 Running FRNT or RSTP over Link Aggregates

It is possible to run FRNT (chapter 16) or RSTP (chapter 18) over a link aggregate. Fig. 20.3 shows an example of using FRNT together with link aggregation.

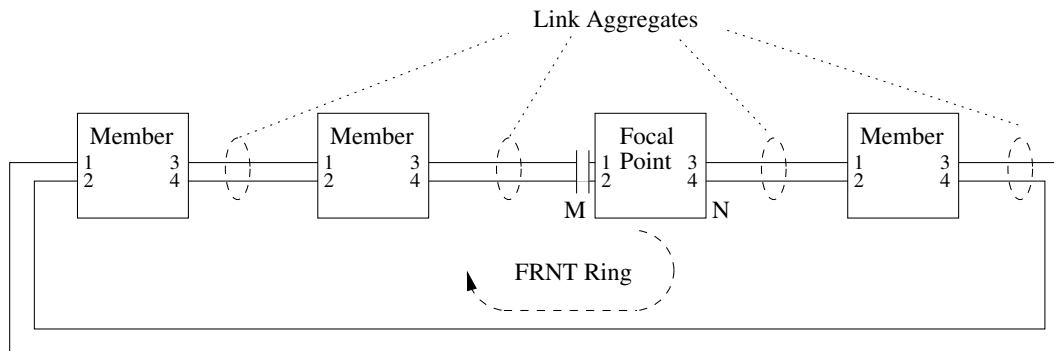

Figure 20.3: FRNT can run over aggregated links

Additional information on running RSTP over a link aggregate:

- *Failover performance:* RSTP failover performance may be degraded when running RSTP over a link aggregate as opposed to using regular links.
- *Forwarding/Blocking state:* An aggregate is forwarding data packets only if *both* RSTP and the link aggregate itself determine that it should be in forwarding state.
- *RSTP link cost:* The RSTP link cost can be configured manually. If "auto" is used for cost calculation, WeOS determines the aggregate link cost based the aggregated bandwidth of the member ports (higher aggregated capacity gives lower RSTP cost).
- *Link Up/Down:* An aggregate is up if at least one of its member ports are considered up. An aggregate is down if all its member ports are down.

Example

```
example:/#> configure
example:/config/#> spanning-tree
example:/config/spanning-tree/#> stp-port A1
example:/config/spanning-tree/stp-port-A1/#> no admin-edge
example:/config/spanning-tree/stp-port-A1/#> show
Port      Enabled Admin-Edge Path-cost
=====
Agg A1    YES      NO          AUTO
```

Additional information on running FRNT over a link aggregate:

- *Failover performance:* FRNT failover performance may be degraded when running FRNT over a link aggregate as opposed to using regular links.
- *Forwarding/Blocking state:* An aggregate is forwarding data packets only if *both* FRNT and the link aggregate itself determine that it should be in forwarding state.
- *Link Up/Down:* An aggregate is up if at least one of its member ports are considered up. An aggregate is down if all its member ports are down.
- *Mixing aggregated and regular links:* The topology in [fig. 20.3](#) uses link aggregation throughout the whole FRNT ring. It is possible to run link aggregation on a subset of the links in the FRNT ring.

Example

```
example:/#> configure
example:/config/#> frnt 1
example:/config/frnt-1/#> ring-ports A1,A2
example:/config/frnt-1/#> leave
example:/#> show frnt
Ring#                : 1
Version              : FRNTv0
Enabled              : Yes, running as PID 1585
Ring Status          : OK
Topology Change Count : 2
Time Since Last Change : 0 Days 0 Hours 0 Mins 14 Secs
Mode                 : Focal Point
Ring ports swapped   : No
Port M                : Agg A1    UP   Blocking
Port N                : Agg A2    UP   Forwarding
```

20.1.4.5 Link Aggregation and other Low-level WeOS features

Use of link aggregation with other low-level features, e.g., *port monitoring* ([chapter 26](#)), *port access control* ([section 15.2](#) and [chapter 9](#)), etc. is not supported as of WeOS v4.33.0. To use those features together with link aggregation it may be possible to specify the individual member ports in the configuration, however, the behaviour is undefined and its use is unsupported.

20.2 Link Aggregation Settings and Status via the Web Interface

20.2.1 Configuring Link Aggregation Settings via the Web Interface



Menu path: Configuration ⇒ Port ⇒ Aggregate

On the Link Aggregate overview page all configured link aggregates will be presented in a list, see below.

When first accessing this page link aggregates can be created by pressing the **New** button.

Aggregate

Name	Ports	Type		
A1	2/1-2/3	lACP		
A2	3/1-3/3	lACP		
A3	3/6-3/8	lACP		

Name	The link aggregate name.
Ports	The set of ports defined for this aggregate.
Type	The type of the aggregate, Static or LACP .
 Edit	Click this icon to edit an existing aggregate.
 Delete	Click this icon to remove an aggregate. You will be asked to acknowledge the removal before it is actually executed.
New	Click the New button to create a new link aggregate.

20.2.2 Create new link aggregate using the web interface

Menu path: Configuration ⇒ Port ⇒ Aggregate ⇒ **New**

When clicking the **New** button, you will be presented to the aggregate *new* page.

Aggregate, New

Name	The link aggregate name. Valid values are A{n} or a{n}, where n is an integer.
Ports	The set of ports to be included in this aggregate. Only ports in the same slot may be aggregated together.
Type	The type of the aggregate, Static or LACP .
LACP Mode	Only available for type LACP. Modes: Active Always send frames (LACP-PDUs) along the configured links. Passive Only send frames (LACP-PDUs) along the configured links if any LACP-PDU frames have been received.
LACP Timeout	Only available for type LACP. The type of the aggregate: Short 3 seconds Long 90 seconds

For more information, see [section 20.1](#).

20.2.3 Edit link aggregate settings using the web interface

Menu path: Configuration ⇒ Port ⇒ Aggregate ⇒ 

When clicking the *Edit* icon for an aggregate you will be presented to the aggregate edit page, which is identical to the *new* page. See [section 20.2.2](#) for description of fields.

20.2.4 Link Aggregation Status via the Web Interface

Menu path: Status ⇒ Port ⇒ Aggregate

This page display status information for the currently configured link aggregates.

Aggregate Status

Name	Link	Mac	Type	Port																				
A1	UP	00:07:7c:82:1f:c9	lacp	<table border="1"> <thead> <tr> <th>Label</th> <th>Link</th> <th>Active</th> <th>Link State</th> <th>LACP State</th> </tr> </thead> <tbody> <tr> <td>Eth 2/1</td> <td>UP</td> <td>No</td> <td>FORWARDING</td> <td>DISTRIBUTING</td> </tr> <tr> <td>Eth 2/2</td> <td>Down</td> <td>No</td> <td>BLOCKING</td> <td>ATTACHED</td> </tr> <tr> <td>Eth 2/3</td> <td>Down</td> <td>No</td> <td>BLOCKING</td> <td>ATTACHED</td> </tr> </tbody> </table>	Label	Link	Active	Link State	LACP State	Eth 2/1	UP	No	FORWARDING	DISTRIBUTING	Eth 2/2	Down	No	BLOCKING	ATTACHED	Eth 2/3	Down	No	BLOCKING	ATTACHED
				Label	Link	Active	Link State	LACP State																
				Eth 2/1	UP	No	FORWARDING	DISTRIBUTING																
Eth 2/2	Down	No	BLOCKING	ATTACHED																				
Eth 2/3	Down	No	BLOCKING	ATTACHED																				
A2	Down	00:07:7c:82:1f:cd	lacp	<table border="1"> <thead> <tr> <th>Label</th> <th>Link</th> <th>Active</th> <th>Link State</th> <th>LACP State</th> </tr> </thead> <tbody> <tr> <td>Eth 3/1</td> <td>Down</td> <td>No</td> <td>BLOCKING</td> <td>ATTACHED</td> </tr> <tr> <td>Eth 3/2</td> <td>Down</td> <td>No</td> <td>BLOCKING</td> <td>ATTACHED</td> </tr> <tr> <td>Eth 3/3</td> <td>Down</td> <td>No</td> <td>BLOCKING</td> <td>ATTACHED</td> </tr> </tbody> </table>	Label	Link	Active	Link State	LACP State	Eth 3/1	Down	No	BLOCKING	ATTACHED	Eth 3/2	Down	No	BLOCKING	ATTACHED	Eth 3/3	Down	No	BLOCKING	ATTACHED
				Label	Link	Active	Link State	LACP State																
				Eth 3/1	Down	No	BLOCKING	ATTACHED																
Eth 3/2	Down	No	BLOCKING	ATTACHED																				
Eth 3/3	Down	No	BLOCKING	ATTACHED																				
A3	UP	00:07:7c:82:1f:d2	lacp	<table border="1"> <thead> <tr> <th>Label</th> <th>Link</th> <th>Active</th> <th>Link State</th> <th>LACP State</th> </tr> </thead> <tbody> <tr> <td>Eth 3/6</td> <td>UP</td> <td>Yes</td> <td>FORWARDING</td> <td>DISTRIBUTING</td> </tr> <tr> <td>Eth 3/7</td> <td>Down</td> <td>No</td> <td>BLOCKING</td> <td>ATTACHED</td> </tr> <tr> <td>Eth 3/8</td> <td>UP</td> <td>Yes</td> <td>FORWARDING</td> <td>DISTRIBUTING</td> </tr> </tbody> </table>	Label	Link	Active	Link State	LACP State	Eth 3/6	UP	Yes	FORWARDING	DISTRIBUTING	Eth 3/7	Down	No	BLOCKING	ATTACHED	Eth 3/8	UP	Yes	FORWARDING	DISTRIBUTING
				Label	Link	Active	Link State	LACP State																
				Eth 3/6	UP	Yes	FORWARDING	DISTRIBUTING																
Eth 3/7	Down	No	BLOCKING	ATTACHED																				
Eth 3/8	UP	Yes	FORWARDING	DISTRIBUTING																				

Auto refresh: Off, [5s](#), [15s](#), [30s](#), [60s](#)

Name	The link aggregate name.
Link	The aggregate link status. Up/Down.
MAC	The aggregate MAC address.
Type	The type of the aggregate, Static or LACP .
Port Label	The port label for the ports included in the aggregate.
Port Link	Up/Down.
Port Active	Indicates if this port is an active member of this aggregate.

Continued on next page

Continued from previous page

<p>Port Link State</p>	<p>The port state for this port.</p> <p>FORWARDING Unit forwards packets. Normal operation.</p> <p>LEARNING The port is preparing itself for entering FORWARDING state. (Only applicable if RSTP/STP is used on the aggregate.)</p> <p>BLOCKING Unit does not forward any packets. The port is put in blocking state by LACP, or by STP/RSTP or FRNT if used on the aggregate.</p> <p>DISABLED Port does not participate in operation.</p>
<p>Port LACP State</p>	<p>The LACP negotiation state for this port: DETACHED, WAITING, ATTACHED, COLLECTING, or DISTRIBUTING. In the DISTRIBUTING state, the port is ready to send and receive data as part of the aggregate. See section 20.1.3 or [21] for more information.</p>

20.3 Managing Link Aggregation via CLI

Command	Default	Section
<u>Configure Link Aggregate</u>		
[no] aggregate <AGGREGATE_ID>	N/A	Section 20.3.1
[no] enable	Enabled	Section 20.3.2
[no] ports <PORTLIST>	N/A	Section 20.3.3
[no] type <static lacp>	lacp	Section 20.3.4
<u>LACP Specific Settings</u>		
[no] active	active	Section 20.3.5
[no] timeout <short long>	short	Section 20.3.6
<u>Aggregate Status</u>		
show aggregate		Section 20.3.7

20.3.1 Manage a Link Aggregate

Syntax [no] aggregate <AGGREGATE_ID>

Context [Global Configuration](#) context

Usage Create, modify or remove a link aggregate.

Enter the Link Aggregate Configuration context of the given aggregate identifier (a0-aN), where N is a number (up to 8 aggregates can be created). If this is a new link aggregate, the aggregate is created.

Use **"no aggregate <AGGREGATE_ID>"** to remove an existing link aggregate, or **"no aggregate"** to remove all link aggregates.

Use **"show aggregate"** to list configured aggregates. To list details of a configured aggregate, enter its configuration context and run **"show"** from there.

Default values When using the **"no aggregate"** form (without providing a specific aggregate ID), all link aggregates are removed.

Example Listing configured aggregates, and listing details for a LACP aggregate.

 **Example**

```
example:/config/#> show aggregate
a1          static 1-2
a2          lacp 5-6
example:/config/#> aggregate a2
example:/config/aggregate-a2/#> show
Name        : a2
Status      : Enabled
Type        : lacp
Ports       : 5-6
LACP mode   : active
LACP timeout : short
example:/config/aggregate-a2/#>
```

20.3.2 Enable/disable a Link Aggregate

Syntax [no] enable

Context [Link Aggregate Configuration](#) context

Usage Enable/disable this aggregate instance. Use **"enable"** to enable and **"no enable"** to disable this aggregate. When disabled, the configured member ports will not be part of this aggregate, i.e., they will operate as regular (non-aggregate) ports.

Use **"show enable"** to view the currently configured setting.

Default values Enabled (**"enable"**)

20.3.3 Configure Link Aggregation Member Ports

Syntax [no] ports <PORTLIST>

Context [Link Aggregate Configuration](#) context

Usage Add/remove a list of ports to/from the port member set of this link aggregate. Use **"no ports"** (without providing a port list) to remove all ports from the member set.

Use **"show ports"** to view the currently configured list of ports.

Default values When using the **"no ports"** form (without providing a specific PORTLIST), all ports are removed.

"PORTLIST" is a comma separated list of port ranges without intermediate spaces, e.g., **"1-2,4"**.

20.3.4 Configure Link Aggregate Control Mode

Syntax [no] type <static|lacp>

Context [Link Aggregate Configuration](#) context

Usage Set mode/operation for this aggregate. Use **"no type"** (without providing a mode) to reset to default value.

Use **"show type"** to view the currently configured mode.

Default values lacp (**"no type"**)

20.3.5 Configure LACP Active/Passive Mode

Syntax [no] active

Context [Link Aggregate Configuration](#) context (only available when aggregate control mode is lacp)

Usage Select LACP mode, i.e. active or passive participation in LACP (see [section 20.1.3](#)). Use **"active"** to select active mode and **"no active"** to select passive mode.

Use **"show active"** to view the currently configured setting.

Default values Active (**"active"**)

20.3.6 Configure LACP Timeout

Syntax [no] timeout <short|long>

Context [Link Aggregate Configuration](#) context (only available when aggregate control mode is lacp)

Usage Select LACP timeout, i.e. the number of seconds before invalidating received LACP information (see [section 20.1.3](#)). Use **"timeout short"** to set the timeout to 3 seconds and **"timeout long"** to set the timeout to 90 seconds.

Use **"show timeout"** to view the currently configured setting.

Default values Short, i.e. 3 seconds (**"no timeout"**)

20.3.7 Show Status of Link Aggregates

Syntax show aggregates

Context Admin Exec context

Usage Display status information for all configured aggregates. The header line displays the aggregate information including the name, its MAC address, and the aggregate control mode.

Each member link is listed with link status, whether or not the link is currently an active member of the aggregate, and the link state.

Aggregates using LACP also displays the LACP state (see [section 20.1.3](#)) and partner information. Partner ID is the system id of the peer, port is the remote port, and key is the operational key. In WeOS, the operational key is equal to the aggregate id.

Default values Not applicable

Example In this example an aggregate (a1) is configured. Both member ports are up, but port 'Eth 5' is unused, since no LACP partner has been discovered on that link.

```

Example
example:/#> show aggregates
Aggregate a1 MAC: 00:07:7c:00:30:b5 Type: lacp
-----
Port      Link  Active  Link State  LACP State  Partner ID      Port  Key
-----
Eth 5     UP   No      Blocking   ATTACHED    00:00:00:00:00:00  0    0
Eth 6     UP   Yes     Forwarding DISTRIBUTING 00:07:7c:00:02:61  2    1
example:/#>
    
```

Example In this example a static aggregate (a2) is configured. Two member ports are up and 'Eth 9' is down.

```

Example
example:/#> show aggregates
Aggregate a2 MAC: 00:07:7c:84:91:6b Type: static
-----
Port      Link  Active  Link State
-----
Eth 7     UP   Yes     Forwarding
    
```

```
Eth 8      UP  Yes   Forwarding
Eth 9      DOWN No    N/A
example: /#>
```

Chapter 21

Multicast in Switched Networks

This chapter gives an overview of multicast in switched networks, with a focus on IP multicast, and how it can be controlled in a WeOS device using IGMP snooping.

21.1 Overview

Feature	Web	CLI	General Description
IGMP Snooping	X	X	Section 21.1.1
IGMP Querier Settings	X	X	Section 21.1.2
IGMP Fast Leave	X	X	Section 21.1.4.3
Multicast Router Ports	X	X	Section 21.1.3
Multicast Flood Reports	X	X	Section 21.1.4.1
Multicast Router Timeout	X	X	Section 21.1.2
Low Bandwidth Networks	X	X	Section 21.1.5
Reserved Multicast Groups	X	X	Section 21.2
View IGMP Snooping Settings	X	X	Section 21.4.10

Multicast, as opposed to unicast, is an efficient means of communicating information to more than one receiver. Compared to broadcast, multicast can be controlled. If these control mechanisms are disabled, multicast will behave like broadcast. The following options exist:

1. treat multicast traffic as broadcast – flood on all ports
2. limit forwarding of multicast only to subscribers
3. flood until subscribers appear, then limiting specific flows

The latter two require switches to inspect control protocol messages exchanged by attached hosts and routers to learn which ports lead to subscribers. In IPv4 this is known as *Internet Group Message Protocol (IGMP) snooping*, RFC4541[4]. A “group” in multicast speak is the IP destination address.

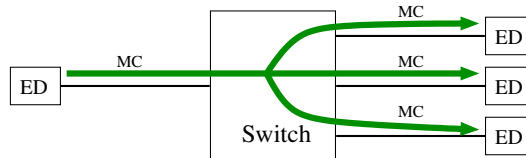

Figure 21.1: Flow of multicast when IGMP snooping is disabled¹.

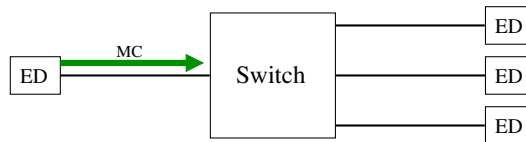

Figure 21.2: Flow of multicast when IGMP snooping is enabled².

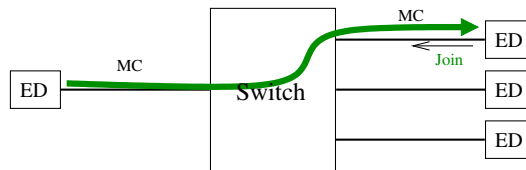

Figure 21.3: Flow of multicast with one subscriber.

Warning

WeOS devices can only limit the broadcast effects of multicast on a Layer-2 basis, it is therefore important to design IPv4 multicast networks so that groups do not overlap. For example, 225.1.2.3 and 226.1.2.3 map to the same multicast MAC address and will effectively be treated as the same group. This means that both groups will be forwarded by the device and potentially overloading the intended receiver. See RFC1112[6], for details on how IP multicast groups map to MAC multicast addresses.

¹Also the flow of multicast when IGMP snooping is enabled and flooding of unknown multicast is enabled (factory default).

²Provided flooding of unknown multicast is disabled. If flooding is enabled, however, the result is the same as in fig. 21.1. For more information, see the following sections.

21.1.1 IGMP Snooping

With IGMP Snooping enabled, switches continuously track subscribed multicast groups and limit their reach to the abilities of the underlying switch fabric. Most devices support limiting up to 2048 groups, with exceptions for devices with fewer ports and hashing algorithms in the switch MAC database. When this resource is exhausted³, the device can be configured to either drop new flows or flood them on all ports (in the same VLAN).

Multicast is either *known* or *unknown*. I.e., the switch either has a matching multicast group entry in its MAC database or not. Unknown multicast can be blocked or flooded by default. Earlier WeOS releases (4.28 and earlier) by default blocked all unknown multicast, but due to the limitations in the underlying fabric, mentioned previously, having a policy of blocking unknown multicast may cause loss of multicast. Blocking also indiscriminately filter ALL multicast, not just IP based but also low-level MAC based protocols, requiring static FDB entries for any (all) traffic that should still be flooded. Which in turn only adds to the exhaustion problem.

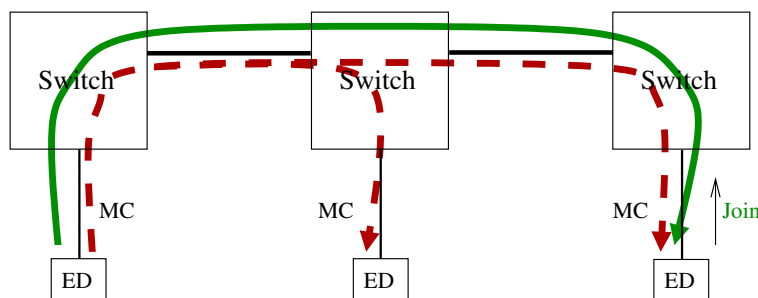

Figure 21.4: Flooding of unknown multicast (dashed red) to all, known multicast (solid green) only to subscribers.

Later WeOS releases allow for the more common paradigm, flood multicast until the network knows more. Here IPv4 multicast is broadcast until an IGMP *join* message⁴ from an end device is received, IGMP snooping in the switch detects this, installs a (temporary static) MAC entry to reclassify the group as known and then forwards the IGMP report to other switches on the LAN. In the event of MAC db exhaustion in this setup, the multicast will still be forwarded.

³Both unicast and multicast MAC addresses are stored hashed in the switch’s MAC database. When addresses hash to the same location they are stored in one of four “bins”, when all these are occupied the db is exhausted. This applies to all products running WeOS 4.

⁴In IGMP v2 the terms are *join* and *leave*, with the collective name *IGMP report*. In IGMP v3 only *report* is used.

Flooding of multicast applies to both IP and MAC multicast alike, IGMP can only limit IPv4 multicast⁵. Flooding is configured per port, meaning any setting made applies to multicast in all VLANs on said ports:

```
example:/config/ip/> [no] multicast-flood-unknown [PORTS]
```

For the most part, users will likely opt for either flood on all ports (the safe default), or none:

- With flooding of unknown multicast *enabled* on all ports, all multicast traffic is forwarded on all ports in the same VLAN, i.e., like broadcast traffic. Only IPv4 multicast may be limited in this mode, and only while at least one subscriber of an IPv4 multicast group is active. The factory default is to flood on all ports (excluding CPU): **"multicast-flood-unknown all"**
- With flooding of unknown multicast *disabled* on all ports, multicast packets are only forwarded on ports leading to a subscriber of an IPv4 multicast group, ports leading to an IP multicast router (i.e., the elected querier or a statically configured multicast router port.), and ports in static FDB filters (see [section 15.4.3](#))

While the **"multicast-flood-unknown"** setting is a global setting in the [IP Configuration](#) context, enabling and disabling of IGMP snooping is done per VLAN (see also [section 15.1.5](#)).

Ports shared between multiple VLANs may have different IGMP snooping settings on different VLANs, i.e., one VLAN may have IGMP snooping *enabled* and another may have it *disabled*. The *disabled* mode takes precedence on such ports, i.e., multicast will be flooded on ports where at least one VLAN has IGMP Snooping *disabled*.

See [section 21.4.7](#) for details on the CLI multicast flood unknown setting.

**Hint**

The factory-config comes with defaults optimised for limiting IP multicast yet allowing for flooding of MAC multicast. Optimising this further is described in [Section 21.1.5](#).

⁵Provided flooding of unknown multicast is enabled (factory default).

21.1.2 IGMP Querier Settings

WeOS devices can act as *IGMP querier* – a role usually handled by *multicast routers*. Switches with IGMP querier capabilities allow for distribution of IP multicast in networks without multicast routers, using IGMP to limit the broadcast effects of multicast. The querier related settings are as follows:

Querier mode: The *auto mode* is the default setting of the switch. It implements the IGMP standard election of a designated IGMP querier on each LAN⁶. In this mode all multicast, both known and unknown, is flooded in the direction of the elected querier and any dynamically detected or statically configured multicast router ports. (In FRNT and MRP ring topologies as well as RiCo setups, multicast is automatically flooded on both ring ports, or all uplinks, when a querier is detected on a ring port, or uplink. This enables quick reconfiguration of both known and unknown multicast in case of ring breakage.)

In *proxy mode*, the switch acts as a forwarder of IGMP queries (and reports) between the elected IGMP querier and end devices. However, to prevent loss of multicast traffic in the case when there is no elected IGMP querier on a LAN, the switch defaults to send *proxy queries*⁷. This feature of proxy mode can be used to optimise low-bandwidth setups, see [section 21.1.5](#) for more information.

On VLANs where the network interface is not assigned an IP address, the switch will automatically fall back to *proxy mode* on that VLAN, regardless of the global querier mode setting.

The proxy query feature can confuse IGMP implementations from some vendors. This may result in other switches forwarding **all** multicast towards the switch originating the proxy query, severely impacting performance by saturating links. Therefore this feature can be disabled, see [section 21.4.3](#), leaving the switch to only forward any IGMP reports (join/leave messages) and IGMP queries, acting as a pure proxy.

Previously a *forced querier mode* existed. It was a non-standard mode for compatibility with pre-WeOS devices. It has been removed since WeOS 4.29.

See [section 21.4.2](#) for how to configure this in the CLI.

⁶The querier with the lowest IP address on each LAN is elected. Usually the gateway or multicast router.

⁷Proxy queries use source IP address 0.0.0.0, which is reserved and must never take part in the IGMP querier election process, as clearly stated in RFC4541[4].

Query interval (QI): When elected as IGMP querier, the switch can emit queries in the range 5-300 sec. This used to be fixed intervals, make sure the setting matches all other switches (and routers) on the LAN that can act as querier. The default value is 125 seconds.

See [Section 21.4.4](#) for how to configure this in the CLI.

Multicast router timeout: When a multicast router, or a switch acting as IGMP querier, goes down, the absence of IGMP Query messages will cause a re-election after the given timeout expires. The default value is 255 seconds. The value should follow the formula $2 * QueryInterval + 10/2$ seconds.

This setting is *critical* to match against all other switches (and routers) on the LAN that can act as querier. When there is a mismatch, odd behavior and loss of multicast traffic will occur.

See [Section 21.4.9](#) for how to configure this in the CLI.

21.1.3 Multicast Router Ports

The switch always forwards *all* multicast traffic, *known* and *unknown*, on *multicast router ports*:

- Ports configured as multicast router ports
- Ports where IGMP Queries are received, usually queries are sent by multicast routers, but also by IGMP snooping switches with querier functionality, like WeOS
- Ports on which Multicast Router Discovery (MRDISC) packets are received, see RFC4286[12]

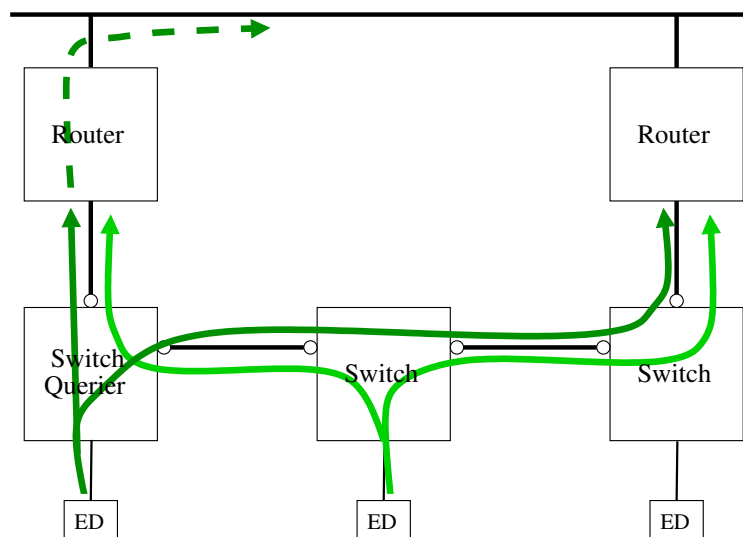

Figure 21.5: Ports to set as multicast-router-ports marked with a ring (o).

In a setup like [fig. 21.5](#), where no FRNT ring is used and the multicast routers⁸ themselves do *not join* the groups they want to route, or *can not* act as IGMP queriers, it is important to set up every port that points to a potential router as a multicast router port. The routers themselves possibly run VRRP, or similar, to ensure only one is active at a time.

FRNT or MRP ring ports are not considered multicast router ports because that controls both *known* and *unknown* multicast alike. Instead, *known* multicast is treated as if the ring is a single port. I.e., when an IGMP report is received on

⁸I.e., not a PIM or DVMRP router, but likely a static multicast router that do not send MRDISC, RFC4286[12], messages to announce themselves.

one ring port, the other ring port is automatically added to the switch MAC filter⁹, which in case of ring breakage ensures an extremely low reconfiguration time.

21.1.4 Optimizations

This section details optimisations that can be made for IGMP snooping in ring topologies. In most cases, however, the factory defaults are good enough. The settings can be used to tweak the behavior of IGMP (signaling) and the reach of multicast traffic flows (data).

21.1.4.1 Multicast Flood Reports

In non-trivial layer-2 topologies, such as multi-ring, ladder, or any spanning tree topology, unknown multicast traffic flows (data, not IGMP signaling) may flood on links where an administrator may not want it to flood.

When multicast is known in one part of the LAN, but flooded in other segments, the **"multicast-flood-reports"** setting may be used to inform IGMP snooping where to safely "leak" IGMP reports to increase the knowledge of other IGMP-aware devices in the network. A report lets these devices reclassify unknown multicast as known, and thus limit the reach of the traffic.

The configuration setting **"multicast-flood-reports auto"** (default) handles FRNT (v0 and v2), RiCo, and MRP topologies automatically. For more advanced setups additional ports can be added.



Warning

Remember, make sure to never forward IGMP reports to end devices! This is particularly important in IGMPv2 networks because of the report suppression mechanism in RFC2236[9].

Fig. 21.6 shows **"multicast-flood-reports auto"** in action. Without this setting, reports are only sent in the direction of the querier, so when the ring changes direction (also known as topology change) due to a link breakage, or loss of a ring switch, the multicast (MC) is flooded to end devices on switches that have not received the IGMP join. The auto setting automatically adds the ring ports, allowing reports to reach all switches (even those beyond the querier), dashed *Join* arrows. So when the ring changes direction these switches are prepared to forward the

⁹This can be seen using the CLI [Admin Exec](#) command **"show fdb"**

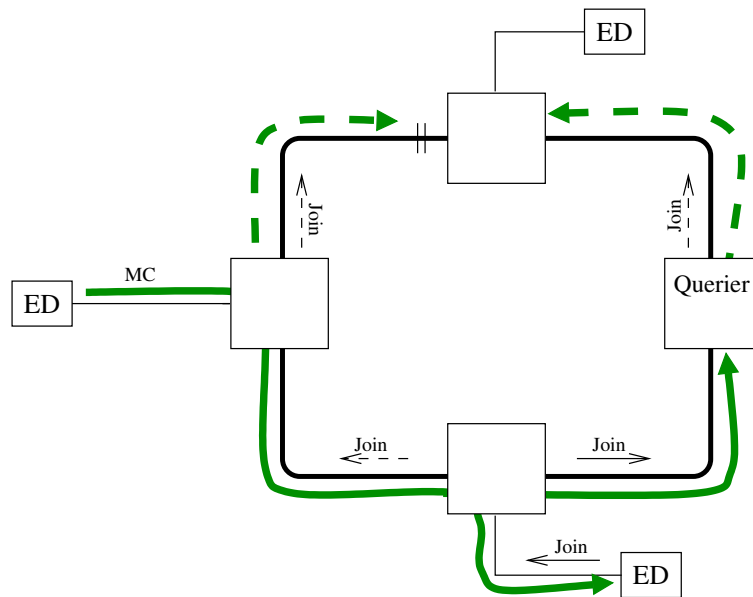

Figure 21.6: Report flooding (dashed Join) prevents flooding to end-device.

multicast only on the ring ports (dashed green MC), but not to any of their end devices (e.g., top ED).

For more information, see [section 21.1.5](#) and [section 21.4.8](#) for details on how to configure this in the CLI.

21.1.4.2 Multi-ring Setups

In setups with multiple layer-2 rings, e.g., connected as depicted in [fig. 21.7](#), unknown multicast is flooded in the middle ring and on all access ports until a receiver joins the group or groups.

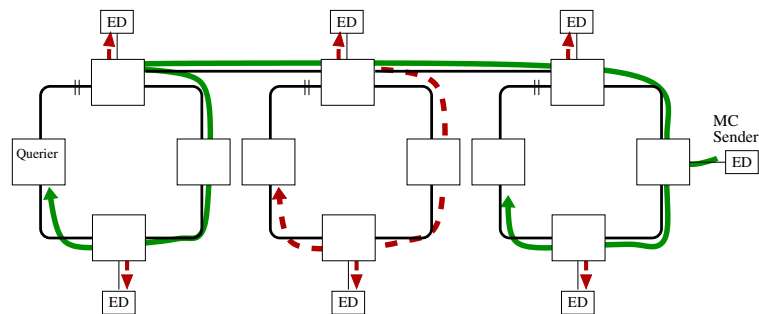

Figure 21.7: Multicast flow before first join, forwarded to Querier.

This is the factory default behavior of WeOS, which remains unless proper counter-measures are taken. One way is to share the knowledge of existing receivers (IGMP group members) across the whole topology, i.e., forward the join messages. In a single ring, or rings bridged with RiCo, this is handled automatically, in more advanced setups some help is needed from the administrator:

1. Enable **"multicast-flood-reports"** on the distribution links. The ring ports, depending on ring protocol, may¹⁰ already be set automatically to flood reports
2. Optionally, selectively disable **"multicast-flood-unknown"** on access ports which cannot handle the startup flood

With this in place, as soon as the first group member sends a report (join), it is flooded towards all other IGMP snooping capable devices on the LAN, [fig. 21.8](#). As a result, multicast data is no longer "leaked" on the middle ring or on any of the end devices in any of the rings.

Note: remember the caveat to disabling flooding; may cause loss of multicast due to hashing to same bucket, as mentioned previously.

¹⁰Depending on what your current configuration is based on.

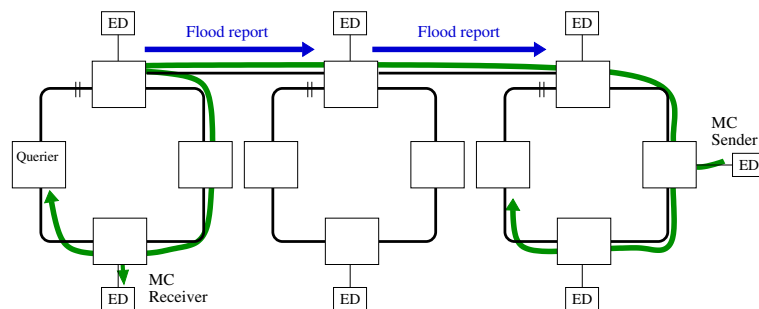

Figure 21.8: Multicast flow after first join, reports flooded on whole LAN.

21.1.4.3 IGMP Fast Leave

Another possible optimisation is to speed up IGMP *leave*. These reports are sent by end devices no longer interested in subscribing to a particular multicast group. The IGMP standard was originally written for hubbed networks, so a *leave* is not immediate by default in consideration of other devices attached to the same “hub”. The same applies to setups with intermediate non-IGMP-aware switches.

It works like this; when a multicast receiver attached to a switch port stops responding to *IGMP Query* messages, the multicast stream will linger for up to $2 * QI + QRI/2$ seconds, i.e., twice the query interval (QI) plus half the query response interval (QRI). With a query interval of 12 seconds this evaluates to $2 * 12 + 10/2 = 29$ seconds. If the receiver sends an *IGMP Leave* message, the leave latency is slightly shorter, up to $1 * QI + QRI/2$, e.g., 17 sec.

When an end device is directly connected to a switch port, the WeOS *Fast Leave* feature may be enabled. When enabled, an *IGMP Leave* causes the multicast group to be immediately pruned.



Note

Remember, multicast filtering depends on how the switch is set up to treat *unknown* multicast, as described previously in [section 21.1.1](#). Hence, when leaving a multicast group it may still be flooded if it becomes classified as unknown.



Example

```
example:/#> configure
example:/config/#> ip
example:/config/ip/#> no igmp-fast-leave-ports
```

```
example:/config/ip/#> igmp-fast-leave-ports eth 3,6
example:/config/ip/#> leave
Configuration activated. Remember "copy run start" to save to flash (NVRAM).
example:/#> copy run start
example:/#> show ip igmp
example:/#> show ip igmp
Configured multicast router ports : ---
Discovered multicast router ports : ---
Fast Leave ports                  : 3, 6
Flood reports on ports            : ---
Known multicast flooded on ports  : ---
Unknown multicast flooded on ports : ---

VID Querier IP      Querier MAC      Port      Interval Timeout
-----
  1 192.168.2.1     LOCAL
VID Multicast Group Filtered MAC Addr Active ports
-----
  1 225.1.2.3      01:00:5E:01:02:03 1, 9, 3
-----
```

21.1.5 Low Bandwidth Networks

In low-bandwidth topologies, like FRNT over an SHDSL ring, you typically cannot afford wasting bandwidth on unwanted traffic. With the IGMP *Proxy Mode*, *Fast Leave* and a few other tricks this can be avoided.

In the default auto mode of IGMP, all multicast, both known and unknown, must per RFC4541[4], section 2.1.2, be forwarded on multicast router ports, i.e., at least the port in the direction of the elected IGMP querier. But if there is no elected querier, and all switches have proxy mode enabled, we can prevent *unknown* multicast from being flooded in the network.

The relevant settings, for *all* switches on the LAN, are:

- Enable IGMP Proxy Mode
- Enable IGMP Fast Leave on all (!) ports
- Enable flooding of IGMP reports on all switches towards other (IGMP-capable) switches (never to end-devices!) on the LAN. In established ring topologies, like FRNT, this is handled automatically
- Disable all flooding of unknown multicast; **"no multicast-flood-unknown"**

Multicast is now only forwarded when a subscriber joins a group. The flooding of reports (join/leave) ensures a distributed state of all receivers on the LAN shared between all switches. When the subscriber joins a group the multicast is classified as *known* and forwarded on the LAN to the receiver. By also enabling Fast Leave, on the access port towards the receiver, the multicast overhead can be kept to a near minimum.

For more advanced LAN topologies, multiple rings, sub-rings, etc, the *auto* setting to **"multicast-flood-reports"** cannot safely detect all possible inter-switch connections. Adding upstream and downstream ports to this list ensures rapid reconfiguration.

 **Note**

By disabling flooding of unknown multicast, and thus *enabling* perfect filtering, limitations in the underlying switch fabric may be triggered. I.e., for certain combinations of multicast groups the switch's MAC db may get full.

Hence, take heed to monitor the system properly at deployment and look out for the following syslog warning:

"Failed adding 01:00:5e:xx:yy:zz to switchcore: ATU full!"

Disabling the FDB profinet support may help "**config/fdb> no profinet**", but usually the only thing that helps is updating the IP address plan for multicast, or enabling flooding of unknown multicast, with the downside, of course, of wasting bandwidth.

21.2 Reserved Multicast Groups

IP multicast in the Local Network Control Block, 224.0.0.x, is reserved for protocols like RIP (224.0.0.9), OSPF (224.0.0.5 and 224.0.0.6), and VRRP (224.0.0.18). Traffic in this range should not be filtered by IGMP Snooping switches[4]. Furthermore, WeOS units filter multicast on the MAC level, and since multiple IP multicast addresses map to the same MAC address, see RFC1112[6], this means there is a larger set of “well-known” reserved groups in consecutive ranges that IGMP does not filter. Any packets received for these groups are flooded on all ports in the same VLAN on which they were received, except the port on which the packets entered the switch.

The table below lists the IP multicast address groups excluded from IGMP filtering, i.e., the 32 well-known address groups (8192 total addresses) that IGMP does not filter.

224.0.0.x	232.0.0.x	224.128.0.x	232.128.0.x
225.0.0.x	233.0.0.x	225.128.0.x	233.128.0.x
226.0.0.x	234.0.0.x	226.128.0.x	234.128.0.x
227.0.0.x	235.0.0.x	227.128.0.x	235.128.0.x
228.0.0.x	236.0.0.x	228.128.0.x	236.128.0.x
229.0.0.x	237.0.0.x	229.128.0.x	237.128.0.x
230.0.0.x	238.0.0.x	230.128.0.x	238.128.0.x
231.0.0.x	239.0.0.x	231.128.0.x	239.128.0.x

Table 21.1: Reserved RFC1112 groups. X is any value from 0 to 255.

21.2.1 FRNT Reserved Groups

If FRNTv0 is enabled there is an additional set of multicast groups that are reserved. FRNTv0 uses the following MAC multicast addresses:

- 01:00:5e:05:0a:01
- 01:00:5e:05:0a:02
- 01:00:5e:05:0a:04
- 01:00:5e:05:0a:05
- 01:00:5e:05:0a:06
- 01:00:5e:05:0a:07

- 01:00:5e:05:0a:08
- 01:00:5e:05:0a:09
- 01:00:5e:05:0a:0a

Reverse mapping, using RFC1112, from MAC to IPv4 multicast, gives us the following reserved IP multicast groups when FRNTv0 is enabled:

224.5.10.x	232.5.10.x	224.133.10.x	232.133.10.x
225.5.10.x	233.5.10.x	225.133.10.x	233.133.10.x
226.5.10.x	234.5.10.x	226.133.10.x	234.133.10.x
227.5.10.x	235.5.10.x	227.133.10.x	235.133.10.x
228.5.10.x	236.5.10.x	228.133.10.x	236.133.10.x
229.5.10.x	237.5.10.x	229.133.10.x	237.133.10.x
230.5.10.x	238.5.10.x	230.133.10.x	238.133.10.x
231.5.10.x	239.5.10.x	231.133.10.x	239.133.10.x

Table 21.2: Reserved FRNTv0 groups. X is one of: 1, 2, 4-10.

21.3 Managing IGMP in the Web Interface

Configuration Overview

Menu path: Configuration ⇒ IGMP

IGMP Snooping





Enabled	Querier Mode	Query Interval	Querier Timeout	
<input type="checkbox"/>	Auto	12	300	





On the IGMP snooping configuration page you will be presented with some of the current settings for IGMP. Click the  icon to change settings.

Configuration settings

Menu path: Configuration ⇒ IGMP⇒ 

IGMP Snooping

Enabled	<input type="checkbox"/>
Querier Mode	<input checked="" type="radio"/> Automatic <input type="radio"/> Proxy
Query Interval	<input type="text" value="12"/>
Querier Timeout	<input type="text" value="300"/>
Proxy Query	<input checked="" type="checkbox"/>
IGMP Fast Leave Ports	None 
Multicast Router Ports	Auto 
Multicast Flood Reports	Auto 
Multicast Flood Unknown	None 

Enabled	Allow per VLAN IGMP snooping, or disable it entirely.
Querier Mode	Selects the IGMP snooping operating mode Automatic: Auto Mode (default) allows the device to take part in the IGMP querier election process. Proxy: Proxy Mode is automatically activated for a VLAN if there is no IP address assigned to its corresponding interface, but it can also be enforced globally here. In Proxy Mode the device acts as a forwarder of queries and membership reports (join/leave). For more information on the modes, see Section 21.1.1
Query Interval	Number of seconds between each query, this must be the same value for all IGMP and IGMP snooping capable devices on a LAN.
Querier Time-out	The amount of time in seconds that must pass before an elected querier (multicast router or IGMP Query capable switch). It currently defaults to 300 sec.to be a backwards compatible.
Proxy Query	Allow sending query with source IP 0.0.0.0 in proxy mode. For more information on the modes, see Section 21.1.2
IGMP Fast Leave Ports	Enable IGMP Fast Leave on ports for end devices. Click the  icon to select ports . See Section 21.1.4.3 for details.
Multicast Router Ports	A selection of ports on which to enable multicast traffic, ALL multicast will forward these ports. The default value for this setting is auto. Click the  icon to select multicast router ports. For more information see Section 21.1.3
Multicast Flood Reports	A selection of ports on which to flood reports to. Click the  icon to select ports . For more information see Section 21.1.4.1
Multicast Flood Unknown	A selection of ports on which to flood unknown multicast traffic. Click the  icon to select ports For more information see Section 21.1.1

Click **Apply** to save and apply the changes.

IGMP Status

Menu path: Configuration ⇒ IGMP Status

IGMP Status

```
Configured multicast router ports : ---
Discovered multicast router ports : 3
Fast Leave ports                  : ---
Flood reports on ports            : 3
Known multicast flooded on ports  : 3
Unknown multicast flooded on ports: ALL
```

VID	Querier IP	Querier MAC	Port	Interval	Timeout
1	10.18.88.94	00:07:7c:6e:35:27	Eth 3	12 sec	297 sec

VID	Multicast Group	Filtered MAC Addr	Active ports
1	224.0.0.252	01:00:5E:00:00:FC	3
1	224.0.0.251	01:00:5E:00:00:FB	3
1	239.255.255.250	01:00:5E:7F:FF:FA	3

Total: 3 filters, max 2048, in 1 VLAN.

Auto-Refresh: Off, [5s](#), [15s](#), [30s](#), [60s](#)

Refresh

21.4 Managing IGMP in the CLI

The available general IP settings and monitoring commands are shown below.

Command	Default	Section
<u>Configure General IGMP Snooping settings</u>		
ip		Section 22.7.1
[no] igmp	Enabled	Section 21.4.1
[no] igmp-mode <auto proxy>	auto	Section 21.4.2
[no] igmp-proxy-query	Enabled	Section 21.4.3
[no] igmp-interval <5-300>	125 sec	Section 21.4.4
[no] igmp-fast-leave-ports [PORTLIST]	Disabled	Section 21.4.5
[no] multicast-router-ports [auto] [PORTLIST]	auto	Section 21.4.6
[no] multicast-flood-unknown [PORTLIST]	all	Section 21.4.7
[no] multicast-flood-reports [auto] [PORTLIST]	auto	Section 21.4.8
[no] multicast-router-timeout <1-2147483647>	255 sec	Section 21.4.9
<u>Per VLAN IGMP Snooping settings</u>		
vlan <VID>		Section 15.4.7
[no] igmp	Enabled	Section 15.4.15
<u>Show IGMP Snooping Status</u>		
show ip igmp		Section 21.4.10

21.4.1 IGMP Control

Syntax [no] igmp

Context [IP Configuration](#) context

Usage This setting controls if IGMP snooping is enabled, and controlled per VLAN, or *globally disabled*.

In previous WeOS releases the only way to entirely disable IGMP snooping was to disable it for all existing, and all new, VLANs. This [IP Configuration](#) setting was added as a convenience.

Default Enabled

21.4.2 IGMP Querier Mode

Syntax [no] igmp-mode <auto|proxy>

Context IP Configuration context

Usage Set IGMP Querier mode. In *auto mode* the device participates in the querier election process (querier with lowest IP becomes querier). In *proxy mode* the device acts as an IGMP proxy, only initiating queries when no other eligible querier is available. This can be disabled using no igmp-proxy-query.

Note: if there is no IP address configured for an interface, the device falls back to proxy mode regardless of the mode setting.

"no igmp-mode" resets the IGMP Querier mode to the default setting ("auto").

Use "show igmp-mode" to view configured IGMP Querier mode.

Default auto

21.4.3 IGMP Proxy Query

Syntax [no] igmp-proxy-query

Context IP Configuration context

Usage This setting controls the sending of IGMP queries on LANs where there is no elected querier, as well as on topology changes and link-up events. It is usually sent with source address 0.0.0.0, which is a reserved address to prevent it from ever becoming a Querier, but on topology changes and link-up events the source IP of the elected querier may be used to facilitate convergence. This function is often referred to as *proxy query*.

When the IGMP querier mode is set to *proxy mode*, or the VLAN interface does not (yet) have a valid IP address, the device will send IGMP queries with source address 0.0.0.0. This feature is for networks where there is no active multicast router, or no IGMP snooping switch has an IP address set (yet). Some multicast receivers do not operate correctly without receiving an IGMP query.

The 0.0.0.0 address must however never win an IGMP querier election. Yet some manufacturers do not handle 0.0.0.0 in a correct manner and this may cause all multicast to be flooded in the direction of the device sending a proxy query, which in turn may lead to saturating low-bandwidth links and loss of function.

Hence, in networks with mixed vendors this setting can be used to prevent this device from ever initiating an IGMP query with source address 0.0.0.0. When the setting is disabled on a device operating in *proxy mode*, the device will only forward incoming IGMP queries.

Default Enabled

21.4.4 IGMP Querier Interval

Syntax [no] igmp-interval <5-300>

Context IP Configuration context

Usage Set IGMP Querier interval (seconds). The same interval is used for all interfaces.

The **"no igmp-interval"** command resets the IGMP Querier interval to the default setting, **"125"** sec. Use **"show igmp-interval"** to view configured IGMP Querier interval.

See [Section 21.4.9](#) for how elected multicast routers (IGMP queriers) time out and recommendations for fail-over.

Default 125 sec.

21.4.5 IGMP Fast Leave

Syntax [no] igmp-fast-leave-ports [PORTLIST]

Context IP Configuration context

Usage Add or remove IGMP Fast Leave ports. For details, see [section 21.1.4.3](#)

"no igmp-fast-leave-ports <PORTLIST>" removes the specified port(s) and **"no igmp-fast-leave-ports"** all ports from the list of IGMP Fast Leave ports.

Use **"show igmp-fast-leave-ports"** to view configured multicast router ports.

Default Disabled

A **"PORTLIST"** is a comma separated list of port ranges, e.g., **"1/1-1/3, 2/3"** or the keyword ALL.

21.4.6 Multicast Router Ports

Syntax [no] multicast-router-ports [auto] [PORTLIST]

Context IP Configuration context

Usage Add or remove multicast router ports. All (layer-2) multicast traffic will be forwarded on multicast router ports, IGMP/MLD control traffic and multicast data alike. For a comparison of alternatives, see [section 21.1.1](#).

"no multicast-router-port PORTLIST" removes the specified port(s) and "no multicast-router-port" removes all ports, including auto, from the list of multicast router ports.

Use "show multicast-router-port" to view configured multicast router ports.

Default auto, i.e., routers are learned on the port where the elected IGMP querier is located, or where MRDISC, RFC4286[12], messages are received. In FRNT and MRP ring topologies, a router learned on a ring port is automatically learned on the other ring port. This to speed up convergence for multicast.

A "PORTLIST" is a comma separated list of port ranges, e.g., "1/1-1/3, 2/3" or the keyword ALL.

21.4.7 Flooding of Unknown Multicast

Syntax [no] multicast-flood-unknown [PORTLIST]

Context IP Configuration context

Usage Add or remove ports from the set where unknown multicast is flooded. This applies to both unknown IP and unknown MAC multicast data, not IGMP/MLD control traffic. For a comparison of alternatives, see [section 21.1.1](#).

"no multicast-flood-unknown PORTLIST" removes the specified port(s) and "no multicast-router-port" removes all ports from the list of multicast router ports.

Use "show multicast-router-port" to view configured multicast router ports.

Note Disabling this function, on one or many ports, will affect multicast based protocols in the 224.0.0.x range. To change a device back to behavior prior to WeOS 4.29, essentially all IP multicast addresses in 224.0.0.x must be

added to the FDB as MAC multicast filters in the range 01:00:5e:00:00:xx, otherwise loss of function will occur.

Default ALL. This is a factory default setting. Hence, upgrading a device from a release prior to WeOS 4.29 will not automatically enable flooding of unknown multicast.

A **"PORTLIST"** is a comma separated list of port ranges, e.g., **"1/1-1/3, 2/3"** or the keyword ALL.

21.4.8 Distribution of Multicast Membership Reports

Syntax [no] multicast-flood-reports [auto] [PORTLIST]

Context IP Configuration context

Usage Add or remove ports from the set where IGMP membership reports are flooded. The default *auto* is sufficient for most setups, see [section 21.1.5](#) for more.

This setting controls the flooding of IGMP membership reports. Reports are always forwarded from an end-device towards an elected querier, detected multicast router ports, and statically configured multicast router ports. But where **"multicast-router-ports"** applies to reports and data alike, this setting only applies to reports.

The major advantage of this over **"multicast-router-ports"** is in setups with low-bandwidth distribution links. The recommendation is to set all switches in IGMP Proxy Mode, disable flooding of unknown multicast, and use this setting to inform each switch of the direction of other IGMP snooping enabled switches, which are potential sources Multicast data flows are only forwarded when end-devices send reports to join a group.

This setting defaults to auto, meaning ports from protocols like FRNT MRP and RiCo are automatically selected. If IGMP snooping, for some reason, is disabled on a neighbor, this setting should be disabled.

Use **"do show ip igmp"** to see which ports are automatically selected.

"no multicast-flood-unknown PORTLIST" removes the specified port(s) and **"no multicast-router-port"** removes all ports from the list of multicast router ports.

Default Auto

A **"PORTLIST"** is a comma separated list of port ranges, e.g., **"1/1-1/3, 2/3"** or the keyword ALL.

21.4.9 Multicast Router Timeout

Syntax [no] multicast-router-timeout <1-2147483647>

Context IP Configuration context

Usage Set the "other Querier present" timer (sec), RFC2236[9] section 8.5. The same interval is used for all interfaces.

This setting controls the amount of time in seconds that must pass before a multicast router (IGMP querier) is considered lost. This setting should have the same value on all devices on a LAN capable of being IGMP querier.

"no multicast-router-timeout" resets the "other IGMP Querier present" timeout to the default setting (**"255"**).

Use **"show multicast-router-timeout"** to view configured "other IGMP Querier present" timeout.

The timeout should be a multiple of the query interval plus half the query response time. RFC2236[9] defines it as: "(*the Robustness Variable*) times (*the Query Interval*) plus (one half of one Query Response Interval). Where the robustness variable in WeOS is hard-coded to two (2), and the query response time is 10 seconds, for all query intervals ≥ 12 , and *query interval* minus two (2) for all query intervals < 12 .

Default 255 sec.

21.4.10 Show IGMP Snooping Status Information

Syntax show ip igmp

Context Admin Exec context

Usage Show IGMP snooping status information. Useful for continuous monitoring in combination with the **"repeat"** CLI prefix command.

Default N/A

Chapter 22

General Interface and Network Settings

This chapter presents WeOS network interface settings, such as the interface IP address and common IP network settings, e.g., default gateway, DNS server and NTP server. Topics specific to various routing protocols and services, e.g., RIP, OSPF, VRRP, etc. are left to [chapters 28-33](#).

[Section 22.1](#) presents the general concepts of network interfaces in WeOS. It also covers the notion of *interface admin distance* and *management interface*, as well as IP related settings for DNS, NTP, etc. [Section 22.4](#) and [section 22.5](#) cover management of interfaces and general network settings via the Web interface. The corresponding CLI settings are divided into [section 22.6](#), interface settings, and [section 22.7](#), general network settings.

22.1 Overview

The table below summarises general interface and network features. [Sections 22.2-22.3](#) contain further information on specific interface and network features.

Feature	Web	CLI	Description
Interface settings			
Enable/disable interface	X	X	Section 22.2.1
MAC address		X	Section 22.2.4
Primary IP address	X	X	Section 22.2.5
Continued on next page			

Continued from previous page			
Feature	Web	CLI	Description
Secondary IP addresses	X	X	Section 22.2.5
Netmask (Prefix Length)	X	X	Section 22.2.5
MTU	X	X	
Interface admin distance	X	X	Section 22.2.6
Management interface	X	X	Section 22.2.7
ICMP Redirect (sending)		X	Section 22.2.8
DHCP client: client ID	X	X	Section 22.2.9
DHCP client: vendor class ID	X	X	Section 22.2.10
DHCP client: option request	X	X	Section 22.2.11
DHCP client: link-local address		X	Section 22.2.5
View interface configuration	X	X	
View interface status	X	X	
<u>General network settings</u>			
Default gateway	X	X	Section 22.3.1
Enable/disable unicast routing	X	X	"
DNS client support			
Set DNS server	X	X	Section 22.3.3
Dynamic DNS	X	X	"
DNS search path		X	"
DNS proxy server support		X	Section 22.3.4
NTP (NTP client/server)	X	X	Section 22.3.2
View general network config.	X	X	
View general network status	X	X	

22.2 Network interfaces

WeOS supports several kinds of network interfaces:

- *LAN/VLAN network interfaces:* A network interface is created for every VLAN configured on the switch ([chapter 15](#)).
- *PPP network interfaces:* (only for WeOS Extended) A network interface is created for every PPP instance configured on the switch ([chapter 35](#)). As of

WeOS v4.33.0, PPP support is available over Ethernet/DSL ports using PPP over Ethernet (PPPoE), and over serial ports with or without external modem.

- *Loopback network interface:* The *loopback* interface *lo* is a logical network interface, which is always present. Its primary IP address cannot be changed, but it is possible to add *secondary* IP addresses, which can be useful in some situations, e.g., for OSPF ([chapter 29](#)).
- *GRE interfaces:* (only for WeOS Extended) For every configured GRE tunnel ([chapter 36](#)), an associated *GRE network interface* is created.
- *SSL interfaces:* (only for WeOS Extended) For every configured SSL VPN tunnel ([chapter 38](#)), an associated *SSL network interface* is created.
- *Blackhole interface:* WeOS has a hidden *blackhole* interface ("**NULL0**"), which can be used to avoid routing loops in case of incomplete subnetting, or to avoid that VPN traffic is forwarded towards the default gateway when the VPN tunnel is down. See [section 28.1.4.4](#).

[Fig. 22.1](#) shows how VLAN interfaces (*vlan1-vlan4*) are mapped to VLANs and ports, i.e., Ethernet and DSL ports. When using PPPoE, a PPP interface is created on top of a VLAN interface (see *pppoe0* and *vlan4* in [fig. 22.1](#)). *modem0* represents the network interface when running PPP over a serial port. The GRE and loopback interfaces are logical interfaces not directly associated with any physical port.

Every network interface can be assigned an IP(v4) address and netmask. By assigning an IP address to an interface, the operator is able to remotely manage the switch via that interface. Furthermore, if routing (IP forwarding) is enabled, the switch is able to *forward* packets *between* network interfaces. [Section 22.3](#) gives a brief overview of WeOS routing features. [chapter 28](#) gives a more detailed introduction to WeOS routing support, while [chapters 29](#) and [30](#) covers dynamic routing with OSPF and RIP.

**Note**

IP forwarding is **not** available for products running software level WeOS Standard. However, it is possible to configure static (unicast) routes in WeOS Standard products as described in [sections 28.2.1](#) (Web) and [22.7.3](#) (CLI).

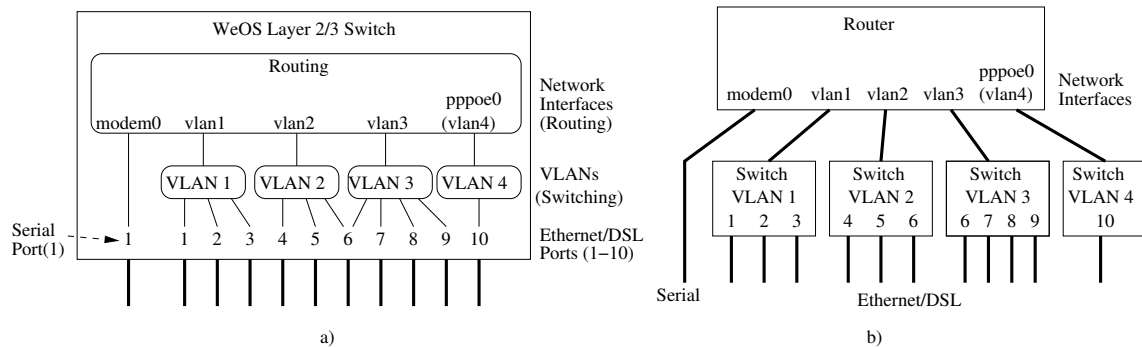

Figure 22.1: A network interface is associated with each VLAN, and VLANs are in turn associated with Ethernet (or DSL) ports as shown in figure a). Furthermore, when using PPPoE, a PPP network interface will be created and mapped on top of an associated VLAN interface, see `ppoe0` and `vlan4`. The routing switch can conceptually be seen as a router connecting a set of switches, as shown in figure b). In this sample setup, port 6 is shared by VLANs 2 and 3 (by use of VLAN tagging).

22.2.1 Interface Operational Status (up/down)

For a network interface to get *operational* status *up*, it must be *enabled* in the configuration. But for some types of interfaces there may be additional criteria to reach interface (operational) status *up*, as shown in the list below:

- *Loopback network interface*: The loopback interface `lo` is always *up*.
- *LAN/VLAN network interfaces*: For a VLAN interface to get status *up*, the interface must be *enabled* and its associated VLAN must also be *up*. In turn, the associated VLAN is *up* when that VLAN is *enabled*, and any of its associated ports have *link up* status. See [chapter 15](#) for more information on VLANs.

Note

It is possible to circumvent the link status propagation property by configuring a LAN/VLAN network interface as always up ("**enable always**", see [section 22.6.2](#)). Disabling link status propagation may significantly impact layer-3 protocols such as RIP, OSPF, VRRP, and more — the protocols will have to fall-back to other methods to detect link-down, e.g. hello message timeout and similar. Do not use the "**enable always**" setting unless you really know what you are doing.

- *PPP network interfaces:* (only for WeOS Extended) For a PPP interface to get status *up*, the PPP interface (and the associated PPP instance) must be enabled and successfully have carried out the PPP handshaking, including PPP authentication and IP address negotiation. For PPPoE, this implies that the underlying VLAN interface must also be up. See [chapter 35](#) for more information on PPP.
- *GRE interfaces:* (only for WeOS Extended) For a GRE interface to get status *up*, the GRE interface (and the associated GRE tunnel instance) must be enabled.

22.2.2 Interface Settings at Factory Default

WeOS products typically have all Ethernet and DSL ports mapped to VLAN 1 by factory default, and the network interface associated with VLAN 1 is named *vlan1*. The exception is Falcon, as described later in this section. Thus by factory default, a WeOS unit has network interfaces *vlan1* and *lo* (logical "loopback" interface).

The factory default settings for interfaces *vlan1* and *lo* are presented below. Most of the loopback settings are permanent (non-configurable).

Interface parameters	Factory Default Setting (General)	
	vlan1	lo
Administrative Mode	Enabled	Enabled
IP address	Dynamic (DHCP)	Static 127.0.0.1
Netmask	(Dynamic)	255.0.0.0
Secondary IP addresses	192.168.2.200	Disabled
Secondary Netmask	255.255.255.0	N/A
MAC address	Auto	N/A
MTU	Auto (1500)	16436
TCP-MSS	Disabled	Disabled
Admin Distance	1	16
Management Interface	Enabled¹	Disabled

The interface *administrative distance* and *management interface* concepts are described in [sections 22.2.6](#) and [22.2.7](#).

As stated earlier, Falcon has a different factory default settings than other WeOS products. The Ethernet ports are all mapped to VLAN 1 and interface *vlan1* as usual, but the Falcon xDSL port resides on a separate VLAN (VLAN 1006) and

interface (*vlan1006*). The factory default settings for the associated interfaces are shown below. Most of the loopback interface (lo) settings are permanent (non-configurable).

Interface parameters	Factory Default Setting (Falcon)		
	vlan1	vlan1006	lo
Administrative Mode	Enabled	Enabled	Enabled
IP address	Static 192.168.2.200	Dynamic (DHCP)	Static 127.0.0.1
Netmask	255.255.255.0	N/A	255.0.0.0
Secondary IP addresses	Disabled	Disabled	Disabled
MAC address	Auto	Auto	N/A
MTU	Auto (1500)	Auto (1500)	16436
TCP-MSS	Disabled	Disabled	Disabled
Admin Distance	16	1	16
Management Interface	Enabled¹	Disabled	Disabled



Note

On Falcon, the xDSL port associated with VLAN 1006 is intended to be used as the upstream "WAN" port for Internet access. Interface *vlan1006* inherits its *admin distance* from the base interface, which by default is 1. For security reasons, management services are filtered out on *vlan1006* by default.

22.2.3 Creating Additional Network Interfaces

As shown in [fig. 22.1](#) the switch will have one network interface for every VLAN defined on the switch. Thus, additional VLAN network interfaces can be created by creating new VLANs (see [chapter 15](#)). Similarly, a PPP network interface is created for every configured PPP instance, a GRE network interface is created for every configured GRE instance, etc.

The default settings for new VLAN and PPP (PPPoE and PPP over serial/modem) interfaces are shown in the table below, followed by a table presenting default settings for GRE and SSL VPN interfaces (PPP, GRE and SSL VPN interfaces are available for products running software level WeOS Extended).

¹At factory default, all management services **except Telnet** are *allowed* on interface *vlan1*.

It is not possible to create additional loopback interfaces. To have additional loopback IP addresses you can instead configure *secondary* IP addresses on the *lo* interface.

Interface Parameters	Default Setting		
	vlan<VID>	pppoe<ID>	modem<ID> ²
Administrative Mode	Enabled	Enabled	Enabled
IP address	Static¹ Disabled	Dynamic³ (IPCP)	Dynamic³ (IPCP)
Netmask	Disabled	N/A	N/A
MAC address	Auto	N/A	N/A
MTU	Auto (1500)	1492⁴	Auto (1500)
Admin Distance	16	"Inherited"	16
TCP-MSS	Disabled	1412	Disabled
Management Interface	Enabled⁵	"Inherited"	Enabled⁴

Interface Parameters	Default Setting	
	gre<ID>	ssl<ID>
Administrative Mode	Enabled	Enabled
IP address	Static Disabled	Static Disabled
Netmask	Disabled	Disabled
MAC address	N/A	Auto⁶
MTU	1476	Auto (1500)
Admin Distance	16	16
TCP-MSS	Disabled	Disabled
Management Interface	Enabled⁵	Enabled⁵

The *interface admin distance* and *management interface* concepts are described in [sections 22.2.6](#) and [22.2.7](#).

¹The exception is interface *vlan1* (VID 1). If *vlan1* does not exist, or if it is created without an address method defined, *vlan1* will default to acquire its address dynamically via DHCP.

²Interfaces for PPP over serial port (modem<ID>) are only available for products equipped a serial port.

³For PPP interfaces, the IP address assignment is handled by the PPP configuration, see [section 35.1.7](#).

⁴When using PPPoE the default PPP interface MTU is 8 bytes less than the associated VLAN interface MTU, which is typically 1500 bytes.

⁵On new interfaces, all management services **except Telnet** are *allowed* by default.

⁶Only layer-2 SSL interfaces have MAC addresses. As of WeOS v4.33.0 the *auto* mode picks a random MAC address, however, this may change in the future WeOS releases.

VLAN network interfaces will be named according to the associated VLAN ID, e.g., the interface of VLAN 100 will be named *vlan100*. PPP, GRE and SSL interfaces will be named according to their associated instance ID, e.g., *pppoe0* is the interface of PPPoE instance "0", *modem0* is the interface of serial/modem instance "0", and so on.

To communicate with the switch via a newly created interface, an IP address must be assigned to the interface, see [section 22.2.5](#).

When creating a PPP instance of type PPPoE, the admin distance and management interface properties of the associated VLAN network interface are *inherited* by the PPP interface. This inheritance does not work in the reverse direction though, i.e., if the PPP instance is removed, the management and admin distance properties of the PPP interface are not passed back to the associated VLAN interface.

**Note**

With PPPoE, one must specify which VLAN interface to run PPPoE over, e.g., see interface *vlan4* in [fig. 22.1](#). The resulting PPP interface will be said to "own" the associated VLAN interface. As of WeOS v4.33.0, it is not possible to access a switch via "owned" VLAN interfaces — access is only possible via the PPP interface.

22.2.4 VLAN Interface MAC address

Each VLAN network interface will be assigned a MAC address (also known as the Ethernet address, the link address, the hardware address, or the IEEE EUI-48 address).

In WeOS products, each *Ethernet port* (or DSL port) is assigned a MAC address, and a *VLAN interface* will by default inherit its MAC address from one of its member ports. It is also possible to manually configure a MAC address for a VLAN interface, see [section 22.6.14](#).

The algorithm to assign VLAN interface MAC address uses the following preference order:

1. If the interface has been configured with a custom MAC address, use that address as the interface MAC address.
2. If the VLAN has one or more ports assigned *untagged*, use the MAC address of the "lowest" untagged port as the interface MAC address.

3. If the port has one or more ports assigned *tagged*, use the MAC address of the "lowest" tagged port as the interface MAC address.
4. Use the MAC address of the *channel* (section 15.1.6) associated with the VLAN.

Consider the sample configuration in fig. 22.1. When all interfaces get their MAC address automatically, interface *vlan1* inherits the MAC address of port 1, *vlan2* inherits its MAC from port 4, *vlan3* from port 7 (assuming port 6 is tagged on VLAN 3), and interface *vlan4* from port 10.

**Note**

For the automatic MAC assignment methods (steps 2-4 above), the MAC address may change when the set of ports associated with the VLAN changes. When this happens, the WeOS device will submit a *gratuitous ARP* to update stale ARP caches in neighbour nodes.

For VLANs created dynamically (section 15.1.7), no associated network interface is created. Thus, for such VLANs no interface MAC address is needed.

22.2.5 IP address settings

Each network interface can be assigned a *primary* IP address and up to 8 *secondary* IP addresses, this is sometimes referred to as multinetting, but can also be another address on the same subnet as the primary address. The primary IP address can either be statically or dynamically assigned, depending on the address method configured for the interface ("**inet static**" or "**inet dynamic**").

The secondary IP addresses can only be statically configured, but can be used with both static and dynamic primary address.

Options for configuring the primary address for different interface types:

- *VLAN interfaces*: The primary IP address of a VLAN interface can be configured statically, or configured to acquire its address dynamically (DHCP). It is also possible to have a VLAN interface without any IP address.
- *PPP interfaces*: For PPP interfaces the address setting is set to *dynamic*, but the actual IP address assignment is handled by the PPP configuration (IPCP), see section 35.1.7.
- *GRE interfaces*: For GRE interfaces, the primary IP address can only be configured statically.

- *Loopback interface (lo)*: The primary IP address of the loopback interface (lo) is permanently set to 127.0.0.1.

In the example below, interface vlan2 is assigned a static primary IP address ("192.168.11.1") and an additional secondary IP address ("192.168.12.1"), i.e., multinetting is used. Here the IP address *netmask* (255.255.255.0) for both addresses has been written in *prefix length* format ('/24').

Example

```
example:/config/#> interface vlan2
example:/config/iface-vlan2/#> inet static
example:/config/iface-vlan2/#> address 192.168.11.1/24
example:/config/iface-vlan2/#> address 192.168.12.1/24 secondary
example:/config/iface-vlan2/#> end
example:/config/#>
```

Interfaces with dynamic address assignment use DHCP to acquire their IP address from a DHCP server, or IPCP for PPP interfaces. If no DHCP server is present, the interface will generally end up without any IP address. The exception is the interface with best *admin distance*, which will also acquire a *link-local* IP address¹. The interface *admin distance* and *link-local address* concepts are further described in [section 22.2.6](#).

22.2.6 Dynamic Address Assignment and Admin Distance

An interface can be configured to retrieve its IP settings dynamically via DHCP (VLAN interfaces) or IPCP (PPP interfaces). In addition to interface settings such as IP address and netmask, the switch can also acquire general network settings such as default gateway and DNS server(s) from the DHCP server, or via PPP. More information on general network settings is given in [section 22.3](#).

Multiple network interfaces can acquire their IP settings dynamically, but only one default route, one set of DNS servers and one domain search path can be active at one time in the system. WeOS handles this using a set of precedence rules. When setting up a device with automatic fail-over between multiple upstream connections these rules are important to be aware of.

Prior to WeOS 4.14.0 the precedence was handled by something called the *primary interface*. However, this has been replaced with the concept of *administrative distance* for both static routes and interfaces. Administrative distance is also

¹Assignment of link-local address can be disabled, see [section 22.6.13](#).

available to dynamic routing protocols such as OSPF and RIP, see [chapters 29](#) and [30](#), respectively.

The admin distance is a priority value ranging from 1–255, where 255 is treated as infinite distance. E.g., a static route installed with distance 255 is guaranteed to never be activated. WeOS makes use of this in fail-over scenarios with multiple upstream interfaces and *ping triggers*.

The following list summarises the rules for dynamically retrieved settings and how they are applied to the system.

- Dynamic IP address and netmask are always set on the interface, without affecting any secondary IP address configured statically.
- Default route, domain search path, and DNS servers are always saved, but not necessarily installed.
- Default routes are installed with the configured interface *admin distance* and the 'best' route is set as the active default route in the system.
- The interface with the best (lowest) distance wins. If that interface goes down, the default route of the next best interface distance is activated.
- If there are multiple interfaces with lowest distance, the system will select one of those interface as 'best'. A user wishing to have full control of what interface is 'best' should assign a unique admin distance per interface.

**Hint**

! Assign unique admin distance values to your interfaces.

- A ping trigger can be associated with the interface distance setting. When it signals loss of connectivity, the distance of the associated default route is raised to infinity (255).
- When the best upstream interface has been established, *domain search path*, *domain name servers* (DNS) and *network time protocol servers* (NTP) are set from that source, unless there exist statically configured settings.
- Statically configured DNS, domain and NTP always win, regardless of any distance.
- *NTP server* may be acquired from a DHCP server when no *NTP server* has been configured statically (see [section 22.3.2](#)).

- The 'primary' setting in WeOS prior to 4.14.0 is converted to a distance value: the primary interface gets distance 1 and all other interfaces get the default distance, 16.
- Static configuration of routes, including the default route, competes with routes learned on DHCP client interfaces *as well as* routes from dynamic routing protocols. An obvious benefit of this is to have a statically configured fallback default route that is activated automatically when no better route is available. This is often referred to as a *floating static route*.
- The default gateway setting "**ip default-gateway <IPADDR>**" is deprecated. Setting up a default gateway in the CLI will install a static default route with distance 1. Use the route command instead (see [section 22.7.3](#), notice the new keyword 'default' for '0.0.0.0/0')

Example

```
example:/config/#> ip route default 192.168.11.1 10
```

In the example below interface *vlan3* is configured to acquire its IP address via DHCP with distance 1. The system default interface, *vlan1* is moved to distance 200 and a *floating static route* to a gateway reachable via *vlan1* is setup with a distance of 200 as well. The default route acquired by DHCP on *vlan3* will be installed with distance 1 and will be made the active route.

Example

```
example:/config/#> interface vlan1
example:/config/iface-vlan1/#> address 192.168.11.2/24
example:/config/iface-vlan1/#> distance 200
example:/config/iface-vlan1/#> end
example:/config/#> interface vlan3
example:/config/iface-vlan3/#> inet dhcp
example:/config/iface-vlan3/#> distance 1
example:/config/iface-vlan3/#> end
example:/config/#> ip default 192.168.11.1 200
example:/config/#>
```

If no DHCP server is present, an interface configured to use DHCP client for address assignment will end up without any IP address. The exception is the DHCP client interface with the best distance, which will also acquire a *link-local* IP address in the range 169.254.0.0/16 in addition to any address assigned via DHCP².

²Assignment of link-local address can be disabled, see [section 22.6.13](#).

The link-local address is taken from the 169.254.0.0/16 range such that address collisions are avoided and that an interface is likely to get the same address every time it comes up.

22.2.7 Management Interface

The operator can manage the switch remotely in several ways: Web (HTTP/HTTPS), SSH, Telnet, SNMP and WeConfig (using the IPConfig service). As described in [chapter 7](#) it is possible to completely disable individual management services, however, there are situations when an operator may wish to limit management access to a certain network interface or VLAN. WeOS provides a powerful mechanism for controlling access to management services on a *per interface* basis. An interface where one or more management services are enabled is referred to as a *management interface*.

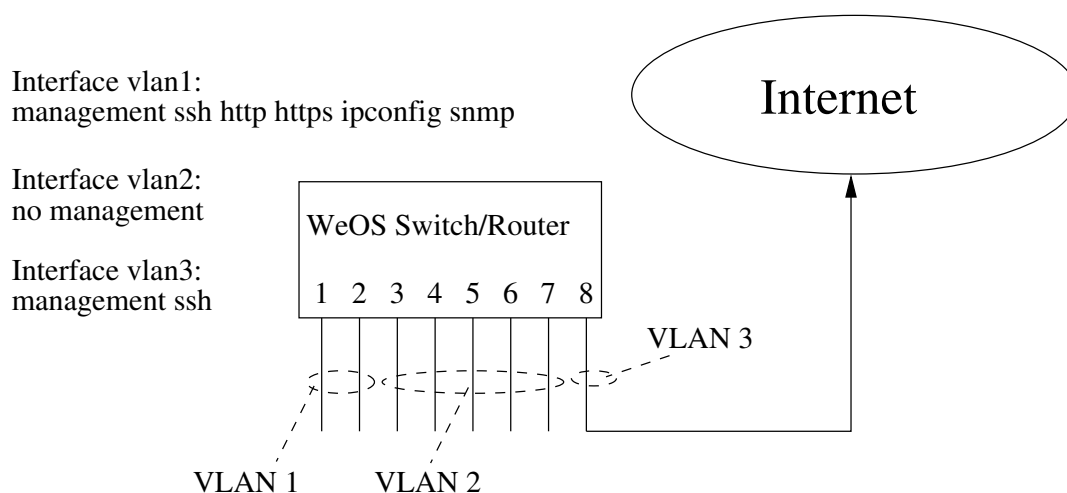



Figure 22.2: Management service filtering per interface.

[Fig. 22.2](#) gives an example on the flexibility by the *management interface* feature in WeOS. The switch has three network interfaces – one for each VLAN. VLAN 1 is the administrator’s local LAN with full management capabilities. VLAN 2 is another local LAN for regular *in-house* users, from which no management is allowed. VLAN 3 is used as the upstream connection; in this example SSH is allowed on this network interface, while other services are disabled.

 **Note**

WeOS use the term *management interface* rather than *management VLAN*. This is because management is not be limited only to VLAN network interfaces. For example, the operator may wish to manage a switch remotely through a modem connection (i.e., a PPP interface on a switch equipped with a serial port).

The equivalent of a management VLAN can be setup by filtering out management services on all interfaces but the network interfaces associated with that VLAN.

The default behaviour aims to avoid unintentional loss of management access to the switch. [Sections 22.2.2](#) and [22.2.3](#) describe the default settings for network interfaces, settings at factory default as well as settings for newly created interfaces³.

 **Warning**

Access to management services on all interfaces is convenient, but may pose a security risk if connected to an untrusted network. By default the device is (typically) manageable via all network interfaces, it is therefore strongly recommended that the operator use either interface management filters to only allow a select set of services (none), or even disable the CPU connection on untrusted networks.

E.g., for an interface connected to the public Internet one should consider disallowing all management services, or perhaps only allow management via secure protocols such as SSH and HTTPS.

Also crucial to cyber security is the password policy and setting up adequately secure passwords when providing management access via an interface connected to an untrusted/public network.

A word of caution is in order, it is entirely possible to get locked out of a device when setting up the management service filter. For devices with a console port this may not be a problem, for others this is the time to be reminded about the "crossed-cables factory reset" ([section 7.1.3.3](#)).

³As mentioned in [section 22.2.2](#) factory default on Falcon switches include a separate VLAN for the xDSL port, and the associated interface (*vlan1006*) has management services disallowed for security purposes.

However, WeOS actually does implement some safeguards to prevent against locking yourself out. If all management is disabled on all interfaces, the system falls back to enabling secure shell, SSH, access on interface *vlan1*. Furthermore, if *Web* (for instance) is the only management service allowed on any interface, but the Web server has been disabled, the same fall-back solution is triggered.

**Hint**

From security standpoint it is recommended to separate the management interface from the upstream WAN interfaces, but also from interface *vlan1* since it is also the fallback interface in WeOS.

E.g., use interface *vlan1* as a LAN interface, with high interface distance, and interface *vlan2* as the upstream WAN interface, with distance 1.

If you, e.g., remove the unrelated VLAN 3 without assigning its ports to any other VLAN, then WeOS will automatically place them as untagged in VLAN 1, the default/fallback VLAN. In most cases you do not want those ports ending up on the upstream side . . .

22.2.8 Control Sending of ICMP Redirect

A WeOS router is able to send ICMP Redirect messages when it receives IP packets which could have been routed more optimal. The topology shown in [fig. 22.3](#) can be used to illustrate a situation where ICMP Redirect is useful.

Assume that *Host 1* (H1) wishes to communicate with *Host 2*, and that H1 (only) knows about its local subnet (192.168.1.0/24) and its default route pointing to Router 1 (R1). In this case all packets from H1 to H2 will go to R1, which in turn sends them back on the same LAN to R2. The packets will be sent twice over the LAN, resulting in waste of network capacity and increased delay. By enabling sending of *ICMP Redirect* on R1, the router will send ICMP Redirect messages to H1, informing the host that it can route packets directly to R2. If the host accepts *ICMP Redirect* messages, it will update its routing table and forward future packets to H2 directly via R2.

In WeOS, the sending of ICMP Redirect messages can be enabled/disabled per network interface. By default sending ICMP Redirect messages is enabled.

**Note**

A WeOS unit does not accept *incoming* ICMP redirect messages.

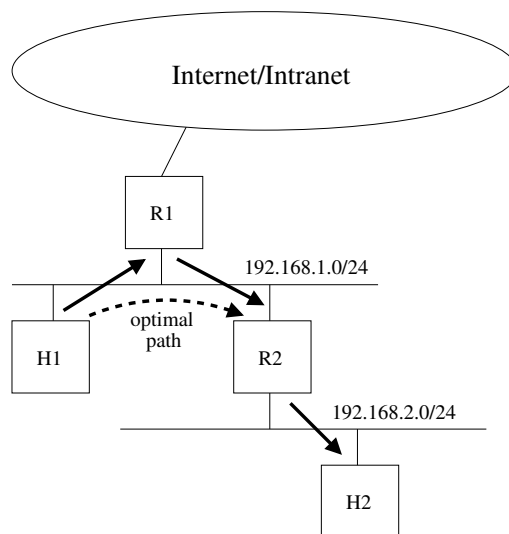

Figure 22.3: Example where ICMP Redirect is useful.

22.2.9 DHCP client identifier

When configuring an interface to use DHCP for address assignment, a WeOS unit will provide a DHCP client-identifier (DHCP option 61) in its communication with the DHCP server. As DHCP servers may use this *Client ID* when assigning host specific IP settings, understanding how the *Client ID* is formed on WeOS units can be useful:

- *MAC based:* By default the WeOS DHCP client forms the Client ID based on the MAC address of the network interface the DHCP client runs on. It forms the Client ID by concatenating '01' and the 'MAC address'[1].

For example, a DHCP client running on a network interface with MAC address '00:07:7c:12:34:56' will send a Client ID as the following sequence of hexadecimal numbers: '0100077c123456'

In WeOS each VLAN network interface is automatically assigned a MAC address according to the algorithm specified in [section 22.2.4](#). You may also configure the MAC address manually.

 **Note**

In cases where several VLANs share the exact same port setup, the automatic algorithm will assign the same MAC address to several VLAN interfaces. This is usually harmless, but if you intend to let your WeOS unit *run a DHCP client on each of those VLAN interfaces* you should assign unique MAC addresses manually. Otherwise your DHCP server may be confused when receiving different client requests reporting the same MAC address.

- **Manual String:** You can also configure the Client ID manually as an ASCII text string. The client ID will then be sent as a sequence of hexadecimal numbers, where each byte holds the ASCII value of the entered text string (e.g., 'a' is sent as hex '61', etc). You have the choice to prepend a '00' byte to the string inline with [1], or to send the string as is ("raw string").

The ASCII string can hold up to MAX_CHARACTERS_CLIENTID (63) characters, and may contain the following characters: a-z, A-Z, 0-9, hyphen ('-') and period ('.') The string may not start or end with a hyphen ('-') or period ('.').

- **Hexadecimal Sequence:** For more flexibility you can configure the Client ID manually as a sequence of hexadecimal numbers (nibbles⁴). The sequence should be an even number of nibbles up to MAX_HEX_NIBBLES_CLIENTID (126) nibbles.

22.2.10 DHCP vendor class identifier

When configuring an interface to use DHCP for address assignment, a WeOS unit will provide a *DHCP vendor class identifier* (DHCP option 60) in its communication with the DHCP server.

By default, WeOS sends the software release identifier (e.g., "WeOS v4.33.0"), but it is also possible to configure the vendor class identifier manually as an ASCII string, up to MAX_CHARACTERS_VENDORCLASSID (63) characters, or a hexadecimal sequence, up to MAX_HEX_NIBBLES_VENDORCLASSID (126) nibbles.

⁴A hexadecimal number can be in range '0-f' corresponding to decimal values 0-15. Each number is referred as a 'nibble'. Each nibble takes 4 bits, thus for every byte sent there are two hexadecimal nibbles.

22.2.11 DHCP Option Request

When configuring an interface to use DHCP for address assignment, a WeOS unit will provide a *DHCP Parameter Request List* (DHCP option 55) in its communication with the DHCP server.

By default, WeOS will provide the following DHCP options in the *DHCP Parameter Request List*:

- *Option 1*: Subnet
- *Option 3*: Router
- *Option 6*: DNS Server
- *Option 7*: Log Server
- *Option 12*: Hostname
- *Option 15*: Domain
- *Option 42*: NTP Server
- *Option 121*: Classless Static Routes
- *Option 249*: Microsoft Classless Static Routes

For the requested options, the WeOS DHCP client will apply the associated responses received by the DHCP server. When a DHCP lease for an interface expires, dynamic interface and system settings that have been installed due to that lease will be removed.

It is possible to configure the device to not include some or all of these options in the *DHCP Parameter Request List*.



Note

Only the DHCP options that are explicitly requested will be used. In other words, if the DHCP server sends options which are not configured on the WeOS DHCP client, the client will ignore them.

DHCP Option 249 is a Microsoft specific variant of option 121. If both 121 and 249 are received as part of a lease, and their contents are identical, only one copy of the relevant routes will be installed on the client. If their content differ, their union will be installed. System administrators should ensure routes advertised by options 121 and 249 are identical.

If DHCP Classless static route option (121 and/or 249) is configured on the WeOS DHCP client, then option 3 should also be configured as required by [29]. If the server provides option 121/249 in its response, it will be used by the client and any response to option 3 will be ignored. See [section 23.3.19](#) for an example of assigning classless static routes via DHCP.

22.3 General IP settings

The general IP settings provided fall into three categories:

- Routing: Configuration of default gateway, static IP routes, and ability to enable/disable IP forwarding (IP forwarding is available for products running software level WeOS Extended).
- IGMP: Configuration of IGMP snooping parameters such as *querier mode*, *query interval* and static multicast router ports. (IGMP snooping is covered in [chapter 21](#).)
- Services: Examples of include settings for DNS and DDNS servers, domain search path, and NTP client/server settings.

22.3.1 Routing

To manage the WeOS unit remotely, it should generally be configured with a default gateway. It is also possible to configure additional, static IP routes.

WeOS units running software level WeOS Extended are capable of *IP forwarding*, i.e., it can *route* incoming IP packets to other interfaces and IP subnets. For unicast, both static routing and dynamic routing (RIP and OSPF) are supported. Units running WeOS Extended act as routers by default, i.e., IP forwarding is *enabled* in the factory default setting.

WeOS units are also able to route IP multicast (static multicast routing). In addition, WeOS devices can efficiently distribute IP multicast packets in a switched LAN by use of IGMP snooping.

This chapter only covers rudimentary routing features, such as enabling/disabling IP forwarding and configuring a default gateway. WeOS routing support is described further in [chapters 28-32](#). IGMP snooping support is covered in [chapter 21](#).

22.3.2 Time synchronisation via NTP Server

The switch can synchronise its clock with an external time server via the NTP protocol. Up to 8 NTP servers can be configured, but it is also possible to acquire NTP server(s) via DHCP when no static NTP server is configured (see [section 22.2.6](#)). It is also possible to enable a local NTP server on this switch which other devices can use.

If the total number of servers manually configured and acquired via DHCP exceeds 8, WeOS employs the following precedence rules to select which to include in the active NTP server list.

- Manually configured server address(es)
- Server address(es) acquired via the default route interface.
- Server address(es) acquired via the lowest administrator distance interface.
- Server address(es) acquired via the next lowest administrator distance interface.

The process is restarted if a new NTP server is configured or acquired via DHCP.

22.3.3 DNS client - setting DNS server and dynamic DNS

Most users find it is easier to refer to Internet hosts using *domain names*, e.g., <http://www.example.com>, than using IP addresses, e.g., <http://93.184.216.119>. To facilitate the use of the Domain Name System (DNS), WeOS supports configuration of up to two DNS server entries. It is also possible to configure a *domain search path*. These settings can also be acquired dynamically via DHCP or PPP (see [section 22.2.6](#)).

Use of domain names on a switch can be convenient, e.g., when setting up ping triggers, VPN peers or when troubleshooting with tools such as *ping* or *tracert*, see [section 7.1.10](#).

It is also convenient to communicate *with* the switch using domain names. When the switch acquires its IP address dynamically (via DHCP or PPP), maintaining the DNS server entry is cumbersome. To manage this situation, WeOS includes support for dynamic DNS (DDNS). With DDNS enabled, the switch will update its DNS server entry automatically when acquiring a new IP address.

Examples of supported DDNS providers are:

- **dyndns:** <http://www.dyndns.org>,
- **freedns:** <http://freedns.afraid.org>
- **no-ip:** <http://www.no-ip.com>

See the CLI or Web online help for a more up-to-date list.

Steps to setup DDNS.

- Get DDNS account and domain name.

- Go to the site of your provider of choice, e.g., DynDNS.
- Set up an account at your provider. Remember your *username* and *secret*, referred to as *AccountName* and *AccountSecret* in the example below.
- Create a domain name (hostname and domain) from the list of available domains at your provider, e.g., *foo.example.com*.
- Configure your WeOS unit to use DDNS with this domain name. **Note:** The example below use an example provider, and dummy hostname and credentials (account name and secret).

Example

```
example:/#> configure
example:/config/#> ip
example:/config/ip/#> ddns
Activating DDNS with default settings, type 'abort' to cancel.
Invalid settings: Invalid login.
example:/config/ip/ddns/#> provider dyndns
example:/config/ip/ddns/#> login AccountName AccountSecret
Invalid settings: Invalid hostname.
example:/config/ip/ddns/#> hostname foo.example.com
example:/config/ip/ddns/#> show
Provider : dyndns
SSL      : Disabled
Login    : AccountName
Password : AccountSecret
Hostname : foo.example.com
Interval : 600
example:/config/ip/ddns/#> leave
```

22.3.4 Proxy DNS server

WeOS units are able to act as DNS proxy servers (enabled by default). When enabled, the unit will act as a DNS server and respond to DNS queries for *known hosts*:

- either statically added by the **"host"** (section 22.7.9), see also the **"show ip host"** (section 22.7.29) command, or
- hosts for which this unit acts as DHCP server (chapter 23), see also the **"show dhcp-clients"** (section 23.3.28) command .

Up to MAX_DNS_HOST_RECORDS (1024) static host records can be configured.

As DNS proxy, the WeOS the unit will also act as a caching DNS forwarder; DNS queries of unknown hosts are forwarded to the unit's own DNS server (see section 22.3.3 and the **"show ip name-server"** command covered in section 22.7.27), and the answer is cached for fast response of subsequent requests for the same host. Domain specific overrides may be set as domain forwarding rules, see section 22.3.4.2.

When proxy DNS server is enabled on a WeOS unit, it will accept incoming DNS packets on all its interfaces.



Hint

For security purposes you may wish to avoid accepting DNS packets on some interfaces, e.g., your upstream interface towards the Internet. To block such request you are recommended to configure appropriate *deny* filter rules, e.g., **"filter deny in vlan1 dport 53 proto udp"** and **"filter deny in vlan1 dport 53 proto tcp"** to block incoming DNS request on interface *vlan1*. For more details on the WeOS firewall, see chapter 33.

Alternatively, disable the DNS proxy service.

For WeOS products running software level WeOS Standard attached directly to the Internet, it is recommended to disable the DNS proxy service.

22.3.4.1 Conditional Domain Forwarding

The unit can also be configured to perform conditional forwarding based on the domain name in the DNS query. By specifying a domain name and the IP(v4) address of the DNS server to which queries should be forwarded, queries for that domain and all its sub-domains will be forwarded to the specified DNS server.

Up to MAX_DOMAIN_FORWARD (1024) rules may be specified. Multiple rules may have the same domain name to provide DNS server redundancy. If a sub-domain rule is specified, the sub-domain rule will have precedence over the domain rule.

For example, consider the following rules:

- **"domain-forward example.net 10.10.10.10"**
- **"domain-forward sub1.example.net 20.20.20.20"**

With these two rules, the unit will forward queries for *www.sub1.example.net* to address *20.20.20.20*, but queries for *www.example.net* to address *10.10.10.10*. Queries for domain names not matching any conditional domain rule will be forwarded to the default DNS server(s), see [section 22.3.3](#).

22.3.4.2 Rejecting AAAA requests

The unit can be configured to reject any IPv6 (AAAA) name resolution requests. By enabling this, all AAAA requests will be refused instead of getting forwarded.

22.4 Managing network interfaces via the web interface

This section covers network interface settings of the unit. Settings related to IGMP snooping is described in [section 21.3](#).

Menu path: Configuration ⇒ Network (IP) ⇒ Interface

Network - Interface

Name	Enabled	Status	Distance	Address method	Address/Netmask	
lo	✓	Up	N/A	Static	127.0.0.1 / 255.0.0.0 192.168.5.0 / 255.255.255.0 192.168.7.85 / 255.255.255.255	
vlan1	✓	Up	16	Static	192.168.2.210 / 255.255.255.0	
vlan2	N/A	Owned (pppoe0)				
vlan3	✓	Up	28	Static	192.168.3.77 / 255.255.255.0	
pppoe0	✓	Down	16	Dynamic	Pending	

Sort by Default ▼ Apply

Name	A unique identifier for the interface. Automatically generated from VLAN/PPP/GRE/SSH identifier when the VLAN/PPP/GRE/SSH/ instance is created. <i>lo</i> is the <i>loopback</i> interface. (PPP, GRE and SSH interfaces are available for WeOS Extended.)
Enabled	Shows whether the interface is enabled or disabled. A green checkmark means the interface is enabled, and a dash means it is disabled.
Status	The status of the interface, <i>Up</i> or <i>Down</i> .
Distance	The administrative distance value used for routes acquired on this interface. Route selection is based on this number. A lower value indicates a more preferred route.
Continued on next page	

Continued from previous page	
Address method	The IPv4 address assignment method used for the interface: <i>Static</i> means the IPv4 address is configured manually, <i>Dynamic</i> means the address is acquired automatically via DHCP (for VLAN interfaces) or is part of the PPP configuration (for PPP interfaces), and <i>Disabled</i> means IPv4 address assignment is disabled on the interface.
Address/Netmask	The IPv4 address, and its associated netmask, assigned to the interface. The netmask identifies what IP addresses are located on the same subnet. Displays configured IP address, when address method <i>Static</i> is used. Displays the dynamically assigned address, or <i>Pending</i> if <i>Dynamic</i> address method is set. Text <i>Disabled</i> is shown if IP address assignment is disabled. Text <i>Owned</i> is shown when there is a PPPoE interface associated with that VLAN interface. Secondary addresses assigned to the interface are also listed.
 Edit	Click this icon to edit the interface.
Sort by	The list of interfaces may be sorted either in a default sort order, or by the distance value. Select desired sort order and press apply button.

When clicking the *Edit* icon for an interface you will be presented to its associated edit page.

Interface vlan1

MAC-Address	00:07:7c:00:02:11		Management services
Enabled	<input checked="" type="checkbox"/>		
Distance	<input type="text" value="16"/>		
IP Address Enabled	<input checked="" type="checkbox"/>		
IP Address Method	<input checked="" type="radio"/> static <input type="radio"/> dynamic		
Primary Address	<input type="text" value="192.168.2.210"/>	<input type="text" value="255.255.255.0"/>	
Secondary Addresses	<input type="text" value="192.168.5.4"/>	<input type="text" value="255.255.255.0"/> 	
MTU	<input type="text" value="Override"/> <input type="text" value="870"/>		
TCP MSS	<input type="text" value="Auto"/> <input type="text" value="1460"/>		
<input type="button" value="Apply"/> <input type="button" value="Cancel"/>			

Note: The user support to only display relevant input fields is only available when using a JavaScript enabled browser.

MAC Address	(Only applicable for VLAN interfaces.) The media access control (MAC) address is used for controlling the communication on OSI layer 2. Shows the MAC-address associated to this interface.
Enabled	The interface may be activated or deactivated by the Enabled setting. Click the check-box to activate/deactivate the interface.
Distance	The administrative distance value used for routes acquired on this interface. Route selection is based on this number. A lower value indicates a more preferred route.
IP Address Enabled	(Only applicable for VLAN interfaces.) When disabling the IP address, traffic may not be sent to the switch from units connected to the VLAN associated with this interface. The address may be disabled to e.g. prevent administration access from specific VLANs. The IP address mode field, and for static address mode the IP address and netmask fields, will not be visible unless this box has been checked.
IP Address Mode	Choose <i>Static</i> to manually configure IP address and netmask or <i>Dynamic</i> to let the unit query a DHCP server for address information.(PPP interfaces can only be specified for dynamic IP address, but the actual IP address assignment is handled by the PPP configuration, see section 35.2.)
Primary Address	The IPv4 address, and its associated netmask, assigned to the interface. The netmask identifies what IP addresses are located on the same subnet. Not applicable for PPP and loopback interfaces. These fields will only be visible if static IP Address Mode has been selected.
Secondary Addresses	Address and netmask for the secondary IPv4-addresses associated to this interface. These fields will only be visible if <i>IP Address Enable</i> has been checked. Up to eight secondary IPv4-addresses may be associated to the interface. Click the plus sign to add new lines. Click the  to delete a row.
Continued on next page	

Continued from previous page	
<p>Client ID Type (Only for Address Method "dynamic')</p>	<p>Select the method to form the DHCP Client ID.</p> <p>Auto The Client ID will be '01'+MAC-Address of interface'.</p> <p>Hex Form Client ID manually from a hexadecimal sequence. Limited to 1-63 octets.</p> <p>String Form Client ID manually from a text string. Limited to 1-63 characters. Valid characters are a-z, A-Z, 0-9, hyphen ('-') and period ('.'). The string shall not start or end with a hyphen ('-') or period ('.'). The Client ID is formed by prefixing the string with '00'.</p> <p>Raw String Same as 'String', except that no '00' prefix is used.</p> <p>For more information about Client ID, see section 22.2.9.</p>
<p>Vendor Class ID (Only for Address Method "dynamic')</p>	<p>Select the method to form the DHCP Vendor Class ID.</p> <p>Auto The Vendor Class ID will be the Software release and number, (WeOS v4.33.0).</p> <p>Hex Form Vendor Class ID manually from a hexadecimal sequence.</p> <p>String Form Vendor Class ID manually from a ASCII string.</p> <p>For more information about Vendor Class ID, see section 22.2.10.</p>
<p>DHCP Client Option (Only for Address Method "dynamic')</p>	<p>Select what DHCP options to request, by default all will be requested.</p> <p>For more information about DHCP Client Option Request, see section 22.2.11.</p>
<p>MTU</p>	<p>This option is not available for all interface types.</p> <p>Override Set a non-default MTU size by entering an override value.</p> <p>Auto The interface will let its MTU be the default MTU of the associated link type.</p>
Continued on next page	

Continued from previous page	
TCP MSS	<p>This option is not available for all interface types.</p> <p>Override Limit TCP-MSS to the given number of bytes.</p> <p>Auto Lets the TCP-MSS depend on the MTU of the interface This will work fine for typical TCP connections, but is not likely to work over IPsec tunnels or when additional IP header options are in use.</p> <p>Disabled Disables TCP-MSS clamping.</p>
Management Services	Check the boxes for the services that should be accessible from this interface.

Click the **Apply** button to save and apply the changes.

22.4.1 Interface Status

Menu path: Status ⇒ Interface

Network Interface Status

Name	Enabled	Status	Distance	Address Method	Address/Netmask	MAC Address
lo	✓	Up	N/A	Static	127.0.0.1 / 8 192.168.5.0 / 24 192.168.7.85 / 32	n/a
vlan1	✓	Up	16	Static	192.168.2.210 / 24	00:07:7c:00:02:11
vlan2	N/A	Owned (pppoe0)				
vlan3	✓	Up	28	Static	192.168.3.77 / 24	00:07:7c:00:02:14
pppoe0	✓	Down	N/A	Dynamic	Pending	P-t-P: 0.0.0.0

Sort by

Name	A unique identifier for the interface. Automatically generated from VLAN/PPP/GRE/SSH identifier when the VLAN/PPP/GRE/SSH/instance is created. <i>lo</i> is the <i>loopback</i> interface. (PPP, GRE and SSH interfaces are available for WeOS Extended.)
Enabled	Shows whether the interface is enabled or disabled. A green check-mark means the interface is enabled, and a dash means it is disabled.
Status	The status of the interface, <i>Up</i> or <i>Down</i> . Text <i>Owned</i> is shown when there is a PPPoE interface associated with the VLAN interface. The <i>owner</i> is also displayed within parenthesis.
Distance	The administrative distance value used for routes acquired on this interface. Route selection is based on this number. A lower value indicates a more preferred route.
Continued on next page	

Continued from previous page	
Address method	The IPv4 address assignment method used for the interface: <i>Static</i> means the IPv4 address is configured manually, <i>Dynamic</i> means the address is acquired automatically via DHCP (for VLAN interfaces) or is part of the PPP configuration (for PPP interfaces), and <i>Disabled</i> means IPv4 address assignment is disabled on the interface.
Address/ Netmask	The IPv4 address, and its associated netmask, assigned to the interface. The netmask identifies what IP addresses are located on the same subnet. Displays configured IP address, when address method <i>Static</i> is used. Displays the dynamically assigned address, or <i>Pending</i> if <i>Dynamic</i> address method is set. Text <i>Disabled</i> is shown if IP address assignment is disabled. Secondary addresses assigned to the interface are also listed.
Sort by	The list of interfaces may be sorted either in a default sort order, or by the distance value. Select desired sort order and press apply button.

22.5 Managing general IP settings via the web interface

This section covers general IP related settings of the unit. Settings related to IGMP snooping are described in [section 21.3](#).

22.5.1 Global Network Settings Overview

Menu path: Configuration ⇒ Network(IP) ⇒ Global settings

When entering the Network(IP) configuration page you will be presented to a list of common network settings.

Network - Global Settings

Global Settings	
Configured Default Gateway	192.168.2.1
Active Default Gateway	192.168.2.1
Routing	Enabled 
Domain Name Server(s)	192.168.2.88 192.168.2.89
Domain Name	

Global Settings (Default Gateway, Routing and DNS servers)

Configured Default Gateway	Statically configured default gateway of the unit. This is the IP address of the gateway to send packages to when no more specific route can be found in the routing table. <i>Empty field</i> indicates that no default gateway address has been statically configured.
Active Default Gateway	The currently active default gateway in use. <i>N/A</i> indicates that no default gateway is in active use. A default gateway cannot be active if no route to the default gateway is available.
Continued on next page	

Continued from previous page	
Routing	(only for WeOS Extended) Routing, also known as IP-forwarding, allows traffic to flow between VLANs. Use the firewall to protect VLANs from unwanted traffic. Texts <i>Enabled</i> and <i>Disabled</i> shows routing status.
Domain Name Server(s)	List manually configured DNS servers. An empty field indicates that no DNS server has been manually configured.
 Edit	Click this icon to edit "this part" of the global settings.

These settings are described further in [section 22.5.2](#).

To change the settings for a specific Interface click the associated edit icon which will take you to the interface settings edit page. Interface settings are described further in [section 22.4](#).

22.5.2 Edit Common Network Settings

Menu path: Configuration ⇒ Network (IP) ⇒ Global settings ⇒ 

Network - Global Settings

Default Gateway	<input type="text" value="192.168.55.11"/>
Routing	<input checked="" type="checkbox"/>
Name server 1	<input type="text"/>
Name server 2	<input type="text"/>

Default Gateway	Statically configured default gateway of the unit. This is the IP address of the gateway to send packages to when no more specific route can be found in the routing table. Leave empty if no default gateway is desired.
Routing	(only for WeOS Extended) Routing, also known as IP-forwarding, allows traffic to flow between VLANs. Use the firewall to protect VLANs from unwanted traffic. Check this box to enable routing, uncheck to disable.
Name server 1	IP address of (primary) DNS server.
Name server 2	IP address of (secondary) DNS server.

Click the **Apply** button to save and apply the changes.

22.5.3 Set System Date and Time

Menu path: Configuration ⇒ System ⇒ Date & Time

Date & Time

Figure 22.4: Switch date and time settings, NTP client/server

Timezone	Select a timezone region to get adjusted local time.
Current Date/Time	Shows current date and time. Click the  icon to manually set date/time.
Remote NTP Server	The IP address of a time server to be used to keep the units calendar time synchronised. Leave empty if you do not want to use a time server, or if NTP server should be acquired via DHCP or PPP.
Local NTP Server	Check if the unit should to serve as NTP server toward NTP clients. It is expected that the unit itself gets it time from a remote (higher level) NTP server, see the Remote NTP Server setting above.

Continued on next page

Continued from previous page

Step Adjust	If the difference for the ntp client time and server time is greater than "threshold" seconds, the ntp client will adjust its clock in a step rather than slewing. This is repeated for up to "limit" number of measurements. "limit 0" means unlimited, i.e., step adjust are always allowed. This is not recommended for regular use, but can be necessary in situations where a network is isolated for long periods of time. "no step-adjust" disables step adjusts.
--------------------	--

**Note**

When setting the timezone using 'Etc/GMT+/-offset', please take into account that the unit is consistent with POSIX, which has positive signs west of Greenwich, while many people expect positive signs east of Greenwich. For example, 'Etc/GMT+4' corresponds to 4 hours behind UT (i.e. west of Greenwich) even though many people would expect it to mean 4 hours ahead of UT (i.e. east of Greenwich).

22.5.4 DDNS settings

Menu path: Configuration ⇒ Network (IP) ⇒ DDNS

Dynamic DNS (DDNS) provider settings

Enabled

Provider	dyndns ▼	SSL <input checked="" type="checkbox"/>
Login	<input type="text"/>	
Password	<input type="text"/>	<input type="checkbox"/>
Hostname	<input type="text"/>	
Interval	600	

Enabled	Check this box to enable Dynamic DNS, uncheck to disable.
Provider	Select DDNS provider. Example of supported providers: dyndns http://www.dyndns.org , freedns http://freedns.afraid.org , and no-ip http://www.no-ip.com See the online help for more.
SSL	Check this box if your DDNS provider supports HTTPS updates.
Login	Set login <i>username</i> for the account at your DDNS provider
Password	Set login <i>password</i> for the account at your DDNS provider
Hostname	Set the DNS hostname, i.e., registered domain name which should map to the IP address of this your switch. When selecting freedns, the domain name must be followed by a hash value (" HOSTNAME, HASH "); the <i>hash</i> is provided by FreeDNS).
Interval	Set the interval by which DDNS verifies that the IP address mapping at your DDNS provider matches the IP address of your switch. Maximum 10 days (864000 seconds).

Click the **Apply** button to save and apply the changes.

22.5.5 Domain Proxy Settings

Menu path: Configuration ⇒ Network (IP) ⇒ DNS Proxy

Domain Proxy

Enabled	<input checked="" type="checkbox"/>	
Forwarding Rules	Domain	Name Server
	foo.example.com	192.168.2.1
	bar.example.com	192.168.3.1
Reject AAAA	<input type="checkbox"/>	

Apply Cancel

Enabled	If checked, the device acts as a DNS proxy server. If not checked the device will not listen to and answer name queries. See section 22.3.4 for more information.
Forwarding Rules	Conditional domain forwarding rules: Domain - The domain for which name queries should be conditionally forwarded. Name Server - The IPv4 address of the name server to which the queries should be conditionally forwarded. See section 22.3.4.2 for more information.
Reject AAAA	If checked, the device will reject all DNS AAAA resolution requests. If not checked the requests will get forwarded.

Click the **Apply** button to save and apply the changes.

22.6 Managing network interfaces via the CLI

The available interface settings and monitoring commands are shown in the table below:

Command	Default	Section
iface <IFNAME> inet <static dynamic>	<i>Differs</i> ¹	Sec. 22.6.1
[no] enable [always]	Enabled	Sec. 22.6.2
[no] address <ADDRESS/LEN ADDRESS NETMASK> [secondary]	Disabled	Sec. 22.6.3
[no] primary	DEPRECATED	Sec. 22.6.4
[no] distance <1-255>	16	Sec. 22.6.5
[no] management <[ssh] [telnet] [http] [https] [ipconfig] [snmp] all>	Enabled ²	Sec. 22.6.6
[no] mtu <68-1500>	<i>Differs</i> ¹	Sec. 22.6.7
[no] tcp-mss <40-1460 auto>	<i>Differs</i> ¹	Sec. 22.6.8
[no] redirect	Enabled	Sec. 22.6.9
<u>Only if "inet" is set to "dynamic"</u>		
[no] clientid <hex string rawstring> <VALUE>	Auto ³	Sec. 22.6.10
[no] vendor-classid <hex string> <VALUE>	Auto ⁴	Sec. 22.6.11
[no] option <OPT> [<OPT>...]	All ⁵	Sec. 22.6.12
[no] zeroconf	Enabled	Sec. 22.6.13
<u>Only for VLAN interfaces</u>		
[no] mac <X:X:X:X:X:X>	Auto	Sec. 22.6.14
<u>Show interface status</u>		
show iface [IFNAME]		Sec. 22.6.15

¹Some interface "native" default settings depend on the interface type, see [section 22.2.3](#). [Section 22.2.2](#) provides information on "factory" default settings.

²By default, all management services **except Telnet** are *allowed* on newly created VLAN and PPP interfaces.

³By default the *Client ID* is formed by concatenating '01' and the 'MAC address', see [section 22.2.9](#).

⁴The *Vendor Class ID* defaults to the release name (WeOS v4.33.0).

⁵By default the *Option* is set to request all options that can be requested, see [section 22.2.11](#) for a list of available DHCP options.

22.6.1 Manage Network Interfaces

Syntax `iface <IFNAME> inet <static|dynamic>`

Context [Global Configuration](#) context

Usage Enter Interface Configuration context, and specify IP address assignment method.

- **"static"** means static IP address assignment. The IP address is configured via the **"[no] address <ADDRESS/LEN|ADDRESS NETMASK>"** command, see [section 22.6.3](#).
- If **"dynamic"** is selected, the switch attempts to acquire its address via DHCP (VLAN interfaces) or IPCP (PPP interfaces). If no DHCP server is available, the interface will generally end up without an IP address. The exception is the interface with best *admin distance*, which also gets a *link-local* IPv4 address⁵.

Use **"show iface"** to show network interface configuration information of all interfaces. Use **"show iface [IFNAME]"** to show configuration information for a specific interface (also available as **"show"** command within the Interface Configuration of that specific interface).

Default values **"static"** for VLAN and GRE interfaces, and **"dynamic"** for PPP interfaces. For VLAN interfaces there is one exception – If *vlan1* does not exist, or if it is created without an address method defined, *vlan1* will default to acquire its address dynamically via DHCP.

⁵Assignment of link-local address can be disabled, see [section 22.6.13](#).

22.6.2 Interface Administrative Mode (Enabled or Not Enabled)

Syntax [no] enable [always]

Context [Interface Configuration](#) context

Usage Bring interface up/down. Note, even if an interface is configured administratively *up*, its operational status may still be *down* if the associated VLAN (or PPP instance) is not up.

Use command **"enable"** to configure an interface as *up*, and **"no enable"** to configure the interface as down. When disabled the CPU connection to that VLAN is also completely severed.



Warning

Specifying no enable means that only layer-2 switching will work on this VLAN. All layer-3 services will stop working. Like management, routing, firewall and so on.

On the upside for **"no enable"** it can be used to stop unwanted traffic from reaching the CPU. For instance it can stop Denial of Service attacks from an external network like the internet and if used together with Q-in-Q (See [section 15.1.9](#)) **"no enable"** can be used to make sure no traffic from the CPU reaches the tunnel and vice-versa.

On LAN/VLAN interfaces, it is possible to circumvent the link status propagation property by configuring an interface as always up (**"enable always"**). However, disabling link status propagation may significantly impact layer-3 protocols such as RIP, OSPF, VRRP, and more -- the protocols will have to fall-back to other methods to detect link-down, e.g. hello message timeout and similar. Do not use the **"enable always"** setting unless you really know what you are doing.



Note

An interface configured as *always up* will in SNMP report *ifOperStatus* "testing(3)".

Use **"show enable"** to show whether this interface is configured as administratively enabled (up) or disabled (down).

Default values Enabled (**"enable"**)

22.6.3 IP Addresses (primary and secondary)

Syntax [no] address <ADDRESS/LEN|ADDRESS NETMASK> [secondary]

Context [Interface Configuration](#) context

Usage Set static IP address and netmask for an interface.

When *static address assignment* is chosen ("**inet static**", see [section 22.6.1](#)), the "**address**" command can be used to the *primary* IP address of the interface, as well as *secondary* IP addresses of the interface (using the "**secondary**") keyword.

When *dynamic address assignment* is chosen ("**inet dynamic**", see [section 22.6.1](#)), the "**address**" command is limited to assign *secondary* IP addresses.

Up to 8 secondary addresses can be configured for an interface.

It is possible to specify the boundary between the *network part* and the *host specific part* of the IP address either as a prefix length (e.g. "**address 192.168.0.1/24**") or as a regular netmask (e.g., "**address 192.168.0.1 255.255.255.0**").

Use "**show address**" to show the IP address setting for this interface.

Default values Disabled (no address). That is, newly created interfaces have no IP address configured, see also [section 22.2.3](#).

22.6.4 Primary Interface

Syntax [no] primary

Context [Interface Configuration](#) context

Usage This command is deprecated and only kept for backwards compatibility when upgrading. It is recommend to instead use the interface admin distance setting ([section 22.6.5](#)).

An old configuration file with this setting is converted to set the selected interface as distance 1 and keep other interfaces at their default distance of 16.

For more information, see [section 22.2.6](#).

22.6.5 Interface Administrative Distance

Syntax [no] distance <1-255> [trigger ID]

Context [Interface Configuration](#) context

Usage Administrative distance for routes learned on this interface.

Static routes learned dynamically, e.g. via DHCP, will be installed in the routing table with this administrative distance.

Possible values are 1-255, where 1 is the best and 255 is infinity, it will be visible in the routing table but will never be activated.

Use the form *no distance* to reset the value to its default value, 16. Use *distance 255* to prevent routes from ever being activated.

A trigger ID may be set, e.g., for monitoring an upstream network with a ping trigger, and dynamically adjusting the default route to infinite distance. Effectively switching to another upstream interface not only on link loss.

For more information, see [section 22.2.6](#).

Default values 16 (no distance)

Notes:

- A PPP interface created via PPPoE will "inherit" the *admin distance* setting from its associated VLAN interface.
- The old *primary* setting on an interface is converted to distance 1 and all other interfaces are shifted downwards in priority.
- This setting does not apply to protocols such as RIP and OSPF.

22.6.6 Management Service Filtering

Syntax [no] management <[ssh][telnet][http][https][ipconfig][snmp]|all>

Context [Interface Configuration](#) context

Usage Filter management services on this interface.

The setting controls what services are allowed to use on this network interface. E.g., "**management ssh https**" adds SSH and HTTPS to the set of services accessible for traffic entering via this interface, and "**no management http**" disallows management via unencrypted HTTP on this interface.

Use **"no management"** to filter out access to all management services on this interface.

Use **"management all"** to allow all management services on this interface.

Use **"show management"** to show the list of currently allowed services via this interface.

Default values All services except **"telnet"** are allowed on newly created interfaces.

Note: PPP interfaces created via PPPoE will inherit the management settings from its associated VLAN interface.

22.6.7 Interface MTU Size

Syntax [no] mtu <68-1500>

Context [Interface Configuration](#) context

Usage Configure a non-default maximum transmission unit (MTU) size (in bytes) for this interface. The MTU size is the packet size a network interface will pass to the link layer for transmission, i.e., the maximum payload of the link layer protocol.

The default is to let the MTU depend on the type of link layer (*auto* mode). For interfaces associated with Ethernet and DSL links this implies a default MTU of 1500 bytes.

For PPP interfaces (PPPoE), the MTU is set to 8 bytes less than the MTU of the associated VLAN interface, which typically implies a PPP interface MTU of 1492 bytes (1500 – 8). This value is set at the time of PPP interface creation; if the VLAN interface MTU is changed afterwards, the PPP interface MTU is **not** updated automatically. Note: The operational MTU can change based on the PPP connection negotiation, see [section 35.3.19](#).

The MTU of GRE interfaces defaults to 1476 bytes.

Changing the MTU of a SSL interface sets the tunnel MTU.

Use **"mtu <68-1500>"** to set a non-default MTU size. Use **"no mtu"** to specify that the interface should let its MTU be the default MTU of the associated link type.

Use **"show mtu"** to show the interface maximum transfer unit (MTU) size setting.

Default values

- *VLAN interfaces*: Auto ("**no mtu**") For Ethernet and DSL links, this implies MTU 1500 bytes.
- *GRE interfaces*: 1476 bytes ("**mtu 1476**")
- *PPP interfaces (PPPoE)*: Typically 1492 bytes ("**mtu 1492**", i.e., 8 bytes less than the associated VLAN interface)

22.6.8 Interface TCP MSS Size

Syntax [no] tcp-mss <40-1460|auto>

Context [Interface Configuration](#) context

Usage Enable/disable TCP-MSS clamping on this interface.

TCP-MSS clamping is used to limit the packet size (or more precisely, limit the "maximum TCP segment size") of TCP connections over the given interface, and is useful in situations where path MTU discovery of some reason does not work.

Enabling TCP-MSS clamping implies additional packet processing, thus it degrades routing performance somewhat. It is disabled by default on most interface types (exception is PPP interface of type PPPoE).

Use "**tcp-mss <BYTES>**" to limit TCP-MSS to the given number of bytes.

Use "**tcp-mss auto**" to let the TCP-MSS depend on the MTU of the interface ("MTU-40", i.e., interface MTU minus typical size of IP and TCP headers). This will work fine for typical TCP connections, but is not likely to work over IPsec tunnels or when additional IP header options are in use.

Use "**no tcp-mss**" to disable TCP-MSS clamping.

Use "**show tcp-mss**" to show the interface maximum TCP segment size (MSS).

Default values Disabled (no tcp-mss) (Exception: "**tcp-mss 1412**" for PPPoE PPP interfaces.)

22.6.9 Sending ICMP Redirect messages

Syntax [no] redirect

Context [Interface Configuration](#) context

Usage Enable/disable sending of ICMP Redirect messages. When enabled on a WeOS router, the router will send ICMP Redirect messages when detecting that packets coming in on this interface have a more optimal route towards the destination.

Use **"redirect"** to enable sending of ICMP Redirect, and **"no redirect"** to disable it.

Use **"show redirect"** to show if sending of ICMP Redirect is enabled or disabled.

Default values Enabled

22.6.10 DHCP Client ID

Syntax [no] `clientid <hex|string|rawstring> <VALUE>`

Context [Interface Configuration](#) context

Usage Configure the Client ID that is sent in DHCP requests. This command is only applicable when DHCP is used for address assignment ([section 22.6.1](#)).

- **Auto:** (Default) Use **"no clientid"** to form the Client ID automatically by concatenating '01' and the MAC address of the interface.
- **Hex:** Use **"clientid hex <VALUE>"** to form the Client from a manual sequence of hexadecimal numbers.
- **String:** Use **"clientid string <VALUE>"** to form the Client ID from a manual string. A prefix '00' will be added.
- **Raw String:** Use **"clientid rawstring <VALUE>"** to form the Client ID from a manual string, without any '00' prefix.

The *Client ID* is restricted to the length of 1-63 string characters or hexadecimal octets. When using the **"string"** or **"rawstring"** method, valid characters are a-z, A-Z, 0-9, hyphen ('-') and period ('.'). The string shall not start or end with a hyphen ('-') or period ('.').

Use **"show clientid"** to show the Client ID setting for this interface.

Default values Auto (form Client ID from MAC address)

Example

Example

```
"clientid hex c0ffee" > 3d 03 c0 ff ee  
"clientid hex c0:ff:ee" > 3d 06 c0 ff ee  
"clientid string coffee" > 3d 07 00 63 6f 66 66 65 65  
"clientid rawstring coffee" > 3d 06 63 6f 66 66 65 65  
"no clientid" > 3d 07 01 00 00 5e 00 53 01
```

The last example assumes the interface has the MAC address 00:00:5e:00:53:01.

22.6.11 DHCP Vendor Class ID

Syntax [no] vendor-classid <hex|string> <VALUE>

Context [Interface Configuration](#) context

Usage Configure the Vendor Class ID (DHCP option 60) sent in DHCP requests. This command is only applicable when DHCP is used for address assignment ([section 22.6.1](#)).

- **Auto:** (Default) Use **"no vendor-classid"** to form the Vendor Class ID automatically as the release name (WeOS v4.33.0).
- **Hex:** Use **"vendor-classid hex <VALUE>"** to form the Vendor Class ID from a manual sequence of hexadecimal numbers.
- **String:** Use **"vendor-classid string <VALUE>"** to form the Client ID from a manual string.

The *Vendor Class ID* is restricted to the length of 1-63 string characters or hexadecimal octets. When using the **"string"** method, valid characters are ASCII 32-126 except double quote ("), i.e., ASCII 34. Double quotes are used to delimit strings including space.

Use **"show vendor-classid"** to show the Vendor Class ID setting for this interface.

Default values Auto (form Vendor Class ID from software release name)

Example

Example

```
vendor-classid hex c0ffee > 3c 03 c0 ff ee
vendor-classid hex c0:ff:ee > 3c 03 c0 ff ee
vendor-classid string coffee > 3c 06 63 6f 66 66 65 65
vendor-classid string "coffee mug" > 3c 0a 63 6f 66 66 65 65 20 6d 75 67
no vendor-classid > reset to send software release name, e.g.,
WeOS v4.33.0 as ASCII string.
```

22.6.12 DHCP Option Request

Syntax [no] option <OPT> [<OPT>...]

Context Interface Configuration context

Usage Configure what DHCP options that should be requested. This command is only applicable when DHCP is used for address assignment ([section 22.6.1](#)).

See [section 22.2.11](#) to see DHCP options relevant for this setting. Use **"option OPT"** to configure the interface to request a specific option. Use **"no option OPT"** to not request the specified option.

Using the command **"no option"** will reset the setting to its default value, requesting all available options.

Use **"show option"** to show the current setting.

Default values All (see [section 22.2.11](#))

Example Do not request DHCP option 7 (Log Server):

Example

```
example:/config/iface-vlan1/#> no option 7
example:/config/iface-vlan1/#> show option
1, 3, 6, 12, 15, 42, 121, 249
example:/config/iface-vlan1/#>
```

22.6.13 Enable/disable link-local address

Syntax [no] zeroconf

Context [Interface Configuration](#) context

Usage Enable/disable assignment of link-local IP address. This command is only applicable when DHCP is used for address assignment ([section 22.6.1](#)).

If no DHCP server is available, an interface will generally end up without an IP address. The exception is the interface with best *admin distance*, which by default is also assigned a *link-local* IPv4 address.

When *link-local* address is undesirable, the **"no zeroconf"** setting can be used to disable it on this interface.

Use **"show zeroconf"** to show the current setting.

Default values Enabled

22.6.14 VLAN Interface MAC address

Syntax [no] mac <X:X:X:X:X:X>

Context [Interface Configuration](#) context

Usage Configure a specific MAC address for this (VLAN) interface. The address is given as a colon-separated hexadecimal string of numbers, e.g., **"mac 00:00:5e:00:53:01"**. Leading zeros can be ignored. Uppercase or lowercase letters can be used.

Use **"no mac"** specify that the interface should get its MAC address automatically.

Use **"show mac"** to show the interface MAC setting for this (VLAN) interface.

For more information, see [section 22.2.4](#).

Default values Auto (no mac)

Example

```
example:/config/iface-vlan1/#> mac 00:00:5e:00:53:01
example:/config/iface-vlan1/#>
```

22.6.15 Show Network Interface Status

Syntax show iface [IFNAME]

Context Admin Exec context.

Usage Show status information for this interface (or all interfaces). If dynamic address assignment is configured on an interface, this command will display the IP address acquired.

Default values Unless a specific interface is specified, status for all interfaces will be shown.

22.7 Managing general IP settings via the CLI

The available general IP settings and monitoring commands are shown below.

Command	Default	Section
<u>Configure general IP settings</u>		
ip		Section 22.7.1
[no] default-gateway <IPADDR>	(DEPRECATED)	Section 22.7.2
[no] route <SUBNET NETMASK NETWORK/LEN> <GATEWAY IFACE> [DISTANCE] [src ADDRESS]	Distance 1	Section 22.7.3
[no] forwarding	Enabled	Section 22.7.4
[no] name-server <IPADDR>	Disabled	Section 22.7.5
[no] domain <DOMAIN>	Disabled	Section 22.7.6
[no] domain-proxy	Enabled	Section 22.7.7
[no] domain-forward <DOMAIN> <IPADDR>		Section 22.7.8
[no] reject-AAAA	Disabled	Section 22.7.10
[no] host <FQDN HOSTNAME> <IPADDR>		Section 22.7.9
[no] ddns	Disabled	Section 22.7.11
[no] provider <dyndns freedns no-ip>	dyndns	Section 22.7.12
[no] ssl	Disabled	Section 22.7.13
[no] login <USERNAME> <PASSWORD>	Disabled	Section 22.7.14
[no] hostname <HOSTNAME>[,HASH]	Disabled	Section 22.7.15
[no] interval <SECONDS>	600	Section 22.7.16
icmp		Section 22.7.17
[no] broadcast-ping	Enabled	Section 22.7.18
[no] ntp	Disabled	Section 22.7.19
[no] enable	Enabled	Section 22.7.20
[no] listen	Disabled	Section 22.7.21
[no] server <FQDN IPADDR>	N/A	Section 22.7.22
[no] enable	Enabled	Section 22.7.23
[no] poll-interval <SECONDS>	600 sec	Section 22.7.24
[no] sntp	(DEPRECATED)	Section ??
[no] server <FQDN IPADDR>	Disabled	Section ??

Continued on next page

Continued from previous page		
Command	Default	Section
[no] poll-interval <SECONDS>	600 sec	Section ??

Continued on next page

Continued from previous page		
Command	Default	Section
<hr/>		
Show general IP status		
show ip route		Section 22.7.26
show ip name-server		Section 22.7.27
show ip domain		Section 22.7.28
show ip host		Section 22.7.29
show ntp		Section 22.7.30

22.7.1 Manage Global IP Settings

Syntax ip

Context [Global Configuration](#) context

Usage Enter IP Configuration context

Use "**show ip**" to show general IP configuration settings.

Default values Not applicable.

22.7.2 Configure IP Default Gateway

Syntax [no] default-gateway <ADDRESS>

Context [IP Configuration](#) context

Usage This command is deprecated and only kept for backwards compatibility when upgrading. It is recommend to instead use the route command since it also has the distance attribute.

A default route configured using this command will always get a distance of 1. With multiple upstream WAN connections using PPPoE or DHCP it is recommended to use the route command instead.

Use "**show gateway**" to show configured default gateway.

Default values Disabled ("**no default-gateway**")

22.7.3 Configure Static IP Routes

Syntax [no] route <SUBNET NETMASK | NETWORK/LEN> <GATEWAY|INTERFACE>
[DISTANCE] [src ADDRESS]

Context IP Configuration context

Usage Add or remove a static IP route, including default routes.

The network boundary of the destination subnet can be given as a netmask (e.g., "**route 192.168.3.0 255.255.255.0 192.168.0.1**") or as a prefix length (e.g., "**route 192.168.3.0/24 192.168.0.1**").

System default routes are setup using the subnet 0.0.0.0 with prefix length 0, but the key keyword 'default' is much easier to use "**route default 192.168.0.1**". The optional distance is useful when setting up backup routes in multiple upstream scenarios where interfaces acquire default routes using PPPoE or DHCP.

The destination network is however typically located *remotely* (specify the next hop gateway, e.g., "**route 192.168.3.0/24 192.168.0.1**"), but it is also possible to use the static route command to specify additional *directly connected* subnets (specify the local interface, e.g., "**route 192.168.3.0/24 vlan1**").

When adding a route on a multihomed unit, the preferred source IP address can be specified with the "src ADDRESS" argument. For example, to use source address 10.0.0.1 with sending to network 10.0.2.0/24 (via 10.0.1.1), use "**route 10.0.2.0/24 10.0.1.1 src 10.0.0.1**" (see [section 28.1.4.3](#)).

Use the "no"-form to remove a static route, e.g., "**no route 192.168.3.0/24 192.168.0.1**".

Use "**show route**" to list configured static routes.

Default values Using "**no route**" (without a subnet address, etc.) removes all configured static routes.

22.7.4 Manage IP Forwarding

Syntax [no] forwarding

Context IP Configuration context

Usage (only for WeOS Extended) Enable/disable IPv4 routing.

Use **"show forwarding"** to show whether IP forwarding (routing) is enabled or disabled.

Default values Enabled (**"forwarding"**)

22.7.5 Name Server (DNS)

Syntax [no] name-server <ADDRESS>

Context IP Configuration context

Usage Add/remove name-server (DNS). Two name-servers can be configured - call the same **"name-server"** command twice.

Run **"no name-server <ADDRESS>"** to remove a specific name server, or **"no name-server"** to remove all configured name servers.

If a name server is not configured using the **"name-server"** command, name server(s) (and domain search path) can be acquired dynamically from an interface with DHCP address assignment.

Use **"show name-server"** to show configured name servers.

Default values Disabled (**"no name-server"**) Running **"no name-server"** (without specifying any name removes all configured name servers.

22.7.6 Domain Search Path

Syntax [no] domain <DOMAIN>

Context IP Configuration context

Usage Add/remove domain search path. A single search path can be added.

Run **"no domain"** to remove the domain search path.

If a name server is not configured using the **"name-server"** command, domain(s) can be acquired dynamically from an interface with DHCP address assignment.

Use **"show domain"** to show configured domain search path.

Default values Disabled (**"no domain"**)

22.7.7 Enable/Disable DNS proxy service

Syntax [no] domain-proxy

Context IP Configuration context

Usage Enable or disable DNS proxy support. When enabled, the unit will act as a DNS server and respond to DNS queries for *known hosts*:

- either statically added by the **"host"** (section 22.7.9), see also the **"show ip host"** (section 22.7.29) command, or
- hosts for which this unit acts as DHCP server (chapter 23), see also the **"show dhcp-clients"** (section 23.3.28) command .

Furthermore, the unit will act as a caching DNS forwarder; DNS queries of unknown hosts are forwarded to the unit's own DNS server (see the **"show ip name-server"** command described in section 22.7.27), and the answer is cached for fast response of subsequent requests for the same host.

Use command **"domain-proxy"** to enable the DNS proxy service, and **"no domain-proxy"** to disable it.

Use **"show domain-proxy"** to view the current setting.

Default values Enabled (**"domain-proxy"**)

Example

```
example:/#> show ip host
127.0.0.1 localhost
127.0.1.1 example.local example

192.168.3.11 mypc
example:/#> ping mypc
Press Ctrl-C to abort PING mypc (192.168.3.11): 56 data bytes
64 bytes from 192.168.3.11: seq=0 ttl=64 time=1.049 ms
64 bytes from 192.168.3.11: seq=1 ttl=64 time=0.627 ms
^C
--- mypc ping statistics ---
2 packets transmitted, 2 packets received, 0% packet loss
round-trip min/avg/max = 0.627/0.838/1.049 ms
example:/#> show dhcp-clients
Lease Time  MAC Address      IP Address      Hostname        Client ID
=====
120         00:07:7c:03:ec:02  192.168.5.106  alice          01:00:07:7c:03:ec:02
example:/#> ping alice
Press Ctrl-C to abort PING alice (192.168.5.106): 56 data bytes
64 bytes from 192.168.5.106: seq=0 ttl=64 time=1.182 ms
64 bytes from 192.168.5.106: seq=1 ttl=64 time=0.754 ms
^C
```

```
--- alice ping statistics ---
2 packets transmitted, 2 packets received, 0% packet loss
round-trip min/avg/max = 0.754/0.968/1.182 ms
example:/#>
```

22.7.8 Add conditional domain forwarding entry

Syntax [no] domain-forward <DOMAIN> <IPADDR>

Context IP Configuration context

Usage Add conditional domain forwarding entries. When an entry exists for a domain, name lookups for the domain will be forwarded to the DNS server specified as IP-address. The server with most specific domain match will be used.

Name lookups for other domains will be handled as described in [section 22.3.4](#).

The commands **"domain-proxy"** and **"no domain-proxy"** ([section 22.7.7](#)) enables and disables the conditional domain forwarding as well.

Use **"show domain-forward"** to view the current setting.

Default values Not applicable (no forwarding entries configured)

Example

```
example:/#> configure ip
example:/config/ip/#> domain-forward example1.org 192.168.2.2
example:/config/ip/#> domain-forward ext.example1.org 192.168.2.3

example:/config/ip/#> show domain-forward

2 domain forwarding entries configured
Domain
=====
example1.org                192.168.2.2
ext.example1.org           192.168.2.3

example:/config/ip/#> leave
example:/#> ping server.example1.org
Press Ctrl-C to abort PING mypc (192.168.2.40): 56 data bytes
64 bytes from 192.168.2.40: seq=0 ttl=64 time=1.049 ms
64 bytes from 192.168.2.40: seq=1 ttl=64 time=0.627 ms
^C
--- mypc ping statistics ---
2 packets transmitted, 2 packets received, 0% packet loss
round-trip min/avg/max = 0.627/0.838/1.049 ms
example:/#> ping server.ext.example1.org
Press Ctrl-C to abort PING mypc (192.168.2.140): 56 data bytes
```

```
64 bytes from 192.168.2.140: seq=0 ttl=64 time=1.049 ms
64 bytes from 192.168.2.140: seq=1 ttl=64 time=0.627 ms
^C
--- mypc ping statistics ---
2 packets transmitted, 2 packets received, 0% packet loss
round-trip min/avg/max = 0.627/0.838/1.049 ms
```

The first name lookup for *server.example1.org* will be forwarded to name-server 192.168.2.2 and the second lookup for *server.ext.example1.org* will be forwarded to name-server 192.168.2.3 due to the matching rules.

22.7.9 Add static hostname lookup entry

Syntax [no] host <FQDN | HOSTNAME> <IPADDR>

Context IP Configuration context

Usage Add or delete entries in the static hostname resolution table (host table). The table is both used when resolving hostnames of DNS requests originating from the unit itself (e.g., when running "**ping www.example.com**" from the CLI command line), and when responding to DNS queries from hosts (assuming this unit is configured as DNS proxy, see [section 22.7.7](#)).

- Hostnames containing a dot (".") are interpreted as fully qualified domain names (FQDN).
- Hostnames without a dot are interpreted as simple hostnames. The system will both be able to resolve DNS queries for the *hostname*, as well as *hostname* concatenated with the unit's *domain search path*. Use "**show ip domain**" ([section 22.7.28](#)) to view the unit's search path domain.

Example

```
example:/#> configure
example:/config/#> ip
example:/config/ip/#> domain example.org
example:/config/ip/#> host mypc 192.168.10.1
example:/config/ip/#> host www.anotherexample.org 10.0.0.1
example:/config/ip/#> leave
example:/#> show ip hosts
127.0.0.1 localhost
127.0.1.1 example.local example

192.168.10.1 mypc mypc.example.org
10.0.0.1 www.anotherexample.org
example:/#> ping mypc
Press Ctrl-C to abort PING mypc (192.168.10.1): 56 data bytes
64 bytes from 192.168.10.1: seq=0 ttl=64 time=8.291 ms
```

```
64 bytes from 192.168.10.1: seq=1 ttl=64 time=0.650 ms
^C
--- mypc ping statistics ---
2 packets transmitted, 2 packets received, 0% packet loss
round-trip min/avg/max = 0.650/4.470/8.291 ms
example:/#>
```

Use **"no host <HOSTNAME>"** to remove a specific entry in the host table, and **"no host"** to remove all configured entries in the host table.

Use **"show host"** to view the currently configured static host entries.

Default values Not applicable (no static host entries configured)

22.7.10 Reject DNS AAAA resolution requests

Syntax [no] reject-AAAA

Context [IP Configuration](#) context

Usage Enable/disable AAAA reject.

Use **"show reject-AAAA"** to show whether AAAA rejecting is enabled or disabled.

Default values Disabled (**"no reject-AAAA"**)

22.7.11 Manage DDNS Settings

Syntax [no] ddns

Context [IP Configuration](#) context

Usage Enter DDNS Configuration context. Upon entering the context, the DDNS service will be enabled. However, it will not be activated until valid DDNS parameters (login, etc.) are configured. Use **"no ddns"** to disable the DDNS service.

Use **"show ddns"** to show configured DDNS settings (also available as **"show"** command within the DDNS Configuration context).

Default values Disabled (**"no ddns"**)

22.7.12 Set DDNS Provider

Syntax [no] provider <dyndns|freedns|no-ip>

Context [DDNS Configuration](#) context

Usage Set DDNS provider. Example of supported providers:

dyndns <http://www.dyndns.org>,

freedns <http://freedns.afraid.org>, and

no-ip <http://www.no-ip.com>

For a complete list of supported DDNS providers, type **"help provider"**.
Use **"no provider"** to return to the default provider setting.

Default values dyndns

22.7.13 Enable HTTPS Updates

Syntax [no] ssl

Context [DDNS Configuration](#) context

Usage Enable/disable HTTPS updates, if the provider supports it.

Use **"show ssl"** to show whether HTTPS updates is enabled or disabled.

Default values Disabled (HTTP)

22.7.14 Set DDNS Login and Password

Syntax [no] login <USERNAME> <PASSWORD>

Context [DDNS Configuration](#) context

Usage Set login *username* and *password* for your account at your DDNS provider (see [section 22.7.12](#)). Use **"no login"** to remove a configured DDNS login setting.

Default values Disabled

22.7.15 Set DDNS Hostname

Syntax [no] hostname <HOSTNAME>[,HASH]

Context [DDNS Configuration](#) context

Usage Set the DNS hostname, i.e., registered domain name which should map to the IP address of this your switch.

When selecting **"provider freedns"**, the domain name must be followed by a hash value (**"hostname HOSTNAME,HASH"**); the *hash* is provided by FreeDNS).

Default values Disabled

22.7.16 Set DDNS interval

Syntax [no] interval <SECONDS>

Context [DDNS Configuration](#) context

Usage Set the interval by which DDNS verifies that the IP address mapping at your DDNS provider matches the IP address of your switch. Maximum 10 days (864000 seconds).

Use **"no interval"** to return to the default provider setting.

Default values 600 (seconds)

22.7.17 Manage ICMP Settings

Syntax icmp

Context [IP Configuration](#) context

Usage Enter ICMP Configuration context.

Use **"show icmp"** to show ICMP settings (also available as **"show"** command within the ICMP Configuration context).

Default values Not applicable.

22.7.18 Enable/disable Broadcast Ping

Syntax [no] broadcast-ping

Context [ICMP Configuration](#) context

Usage Define whether the switch should respond to broadcast "ping" (ICMP Echo Request) messages or not. Responding to broadcast ping is convenient when troubleshooting the network, but can in some situations be considered a security risk.

Use **"no broadcast-ping"** to disable responding to broadcast ping messages.

Use **"show broadcast-ping"** to show whether the switch is configured to respond to broadcast ping messages or not.

Default values Enabled (**"broadcast-ping"**)

22.7.19 Manage NTP Settings

Syntax [no] ntp

Context [Global Configuration](#) context

Usage Enter NTP Configuration context by using the **"ntp"** command.

Use **"no ntp"** to remove all configured NTP settings.

Use **"show ntp"** to show NTP settings (also available as **"show"** command within the NTP Configuration context).

Default values Not applicable.

22.7.20 Enable/Disable NTP Settings

Syntax [no] enable

Context [NTP Configuration](#) context

Usage Enable or disable configured NTP settings.

Use **"enable"** to enable/activate configured NTP settings. Use **"no enable"** to disable/deactivate configured NTP settings (the settings are not removed, only deactivated).

Use **"show enable"** to show whether NTP settings are enabled or disabled.

Default values Enabled

22.7.21 Local NTP Server

Syntax [no] listen

Context [NTP Configuration](#) context

Usage Enable or disable a *local* NTP server.

Use **"listen"** to start a local listening NTP server that others can connect to. (It is expected that the unit itself gets its time from a remote NTP server, see [section 22.7.22.](#)) Use **"no listen"** to disable the local NTP server.

Use **"show listen"** to show whether local NTP server is enabled or disabled.

Default values Disabled

22.7.22 Manage (remote) NTP Server(s)

Syntax [no] server <FQDN|IPADDR>

Context [NTP Configuration](#) context

Usage Add, delete, or manage a *remote* NTP server with specified IP Address or domain name, to set the time on this unit. Up to 8 NTP servers can be configured. With the **"server <FQDN|IPADDR>"** you enter the NTP Remote Server Configuration context for that specific NTP server.

If no (remote) NTP server is configured, the unit can acquire NTP server(s) dynamically from an interface with DHCP address assignment.

Use **"no server <FQDN|IPADDR>"** to remove a specific NTP server, or **"no server"** to remove all configured NTP servers.

Use **"show server"** to show settings for all configured NTP servers, or **"show server <FQDN|IPADDR>"** to show NTP settings for a specific NTP server (also available as **"show"** command within the NTP Remote Server Configuration context).

Default values Not applicable

22.7.23 Enable/Disable (remote) NTP Server

Syntax [no] enable

Context [NTP Remote Server Configuration](#) context

Usage Enable or disable configured settings for this NTP server.

Use **"enable"** to enable/activate configured NTP server settings. Use **"no enable"** to disable/deactivate configured NTP server settings (the settings are not removed, only deactivated).

Use **"show enable"** to show whether NTP server settings are enabled or disabled.

Default values Enabled

22.7.24 Set NTP Server Poll Interval

Syntax [no] poll-interval <30-720>

Context [NTP Remote Server Configuration](#) context

Usage Set NTP server poll interval (in seconds) for this NTP server. "no poll-interval" will reset the poll interval to its default (600 seconds).

Use "show poll-interval" to show configured poll interval.

Default values 600 (seconds)

22.7.25 Set NTP Step Adjust

Syntax [no] step-adjust [threshold <0.1-0.9|1-10>] [limit <0-100>]

Context [NTP Remote Server Configuration](#) context

Usage If the difference for the ntp client time and server time is greater than "threshold" seconds, the ntp client will adjust its clock in a step rather than slewing. This is repeated for up to "limit" number of measurements.

"limit 0" means unlimited, i.e., step adjust are always allowed. This is not recommended for regular use, but can be necessary in situations where a network is isolated for long periods of time.

"no step-adjust" disables step adjusts.

Default: step-adjust threshold 10 limit 1 That is, step-adjust is by default only allowed on the first contact with an NTP server, and if the time-difference is larger than 10 seconds.

Use "show step-adjust" to show configured step adjustment configuration.

Default values Threshold 10 Limit 1

22.7.26 Show IP Forwarding Table

Syntax show ip route

Context [Admin Exec](#) context

Usage Show IP Forwarding table (summary of configured routes and routes acquired dynamically).

Default values Not applicable.

22.7.27 Show Name Server and Domain Search Path Status Information

Syntax show ip name-server

Context Admin Exec context

Usage Show name-server and domain search path status information (statically configured or acquired dynamically)

22.7.28 Show Domain Search Path Status Information

Syntax show ip domain

Context Admin Exec context

Usage Show domain search path status information (statically configured or acquired dynamically)

Example

```
example:/#> show ip domain
example.org
example:/#>
```

22.7.29 Show local host table

Syntax show ip hosts

Context Admin Exec context

Usage Show the local hostname resolution table. Static hostname resolution entries configured with the **"host"** command ([section 22.7.9](#)) are listed, as well as entries for the unit itself (localhost and entries for the unit's own hostname, see [section 8.3.2](#)).

Example

```
example:/#> show ip hosts
127.0.0.1 localhost
127.0.1.1 example.local example

192.168.10.1 mypc mypc.example.org
```

```
10.0.0.1      www.anotherexample.org
example:/#>
```

22.7.30 Show NTP Status Information

Syntax show ntp [verbose]

Context Admin Exec context

Usage Show NTP status information. An asterisk '*' shows which NTP server is used to synchronise the time. For more information, use "**show ntp verbose**".

Example

```
example:/#> show ntp
NTP Client/Server running as PID: 805
210 Number of sources = 2
MS Name/IP address      Stratum Poll Reach LastRx Last sample
=====
^* ntp-anycast.kth.se    2   9   37   370   +222us[ -916ms] +/-  22ms
^- cecar.ddg.lth.se     2   9   37   370   -8317us[-8317us] +/-  81ms
```

22.8 Feature Parameters

MAX_CHARACTERS_CLIENTID	63
MAX_HEX_NIBBLES_CLIENTID	126
MAX_CHARACTERS_VENDORCLASSID	63
MAX_HEX_NIBBLES_VENDORCLASSID	126
MAX_DNS_HOST_RECORDS	1024
MAX_DOMAIN_FORWARD	1024

Chapter 23

DHCP Server

The WeOS DHCP server is capable of handing out IP settings to hosts (DHCP clients) on *local* and *remote* IP subnets. For each defined IP subnet, the DHCP server can assign IP addresses dynamically from a *pool* of addresses, but also statically based on

- the *port* the (DHCP) client is connected to (“one IP per port”, DHCP option 82),
- the DHCP *client identifier* provided by the connecting client,
- the *MAC address* of the connecting client, or
- a combination of DHCP option 82 *and* DHCP client identifier

To serve clients on remote IP subnets, DHCP relay agents would be used to forward the DHCP messages between the clients and the DHCP server. In WeOS you can even configure a DHCP relay agent on the same unit as the DHCP server – this is useful if you wish to hand out addresses per port (DHCP option 82) on the DHCP server unit itself. For more information on configuring DHCP relay agents, see [chapter 24](#).

The WeOS DHCP server is also able to act as a (proxy) DNS server for the DHCP clients it serves (see [section 22.3.4](#)).

Being part of an embedded system, the WeOS DHCP server does *not* store the current set of leases in persistent storage. In most use cases this is fine, however if it necessary that the current lease table survives a reboot you are recommended to use a dedicated DHCP server instead.

23.1 Overview of DHCP Server Support in WeOS

The table below presents a summary of DHCP server functionality in WeOS.

Feature	Web	CLI	General Description
<u>General DHCP Server Functionality</u>			
Enable DHCP Server	X	X	
Define subnets to serve	X	X	Section 23.1.1
Caching DNS server	X	X	Secs. 23.1.1, 22.3.4
Enable/Disable Ping check	X	X	Section 23.1.3
Server Listening UDP Port		X	-"
Server Source UDP Port		X	-"
Address lease preemption	X	X	-"
<u>Client configuration settings</u>			
<u>Client IP assignment and matching</u>			
Address pool	X	X	Section 23.1.2.1
Per port (Option 82)	X	X	Secs. 23.1.2.1, 23.1.4
Per client-ID	X	X	Secs. 23.1.2.1, 23.1.4
Per MAC	X	X	Secs. 23.1.2.1, 23.1.4
Per port & client-ID	X	X	Secs. 23.1.2.1, 23.1.4
Deny client service	X	X	Section 23.1.2.1
<u>Additional client configuration parameters</u>			
Default Gateway	X	X	Section 23.1.2.2
DNS Server	X	X	-"
Log Server	X	X	-"
Classless Route	X	X	-"
Domain search path	X	X	-"
NTP Server	X	X	-"
Hostname	X	X	-"
TFTP Server Name	X	X	-"
TFTP Server Address	X	X	-"
TFTP File	X	X	-"
Lease time	X	X	-"
<u>DHCP Server Status</u>			
List current clients		X	

23.1.1 Introduction to WeOS DHCP server support

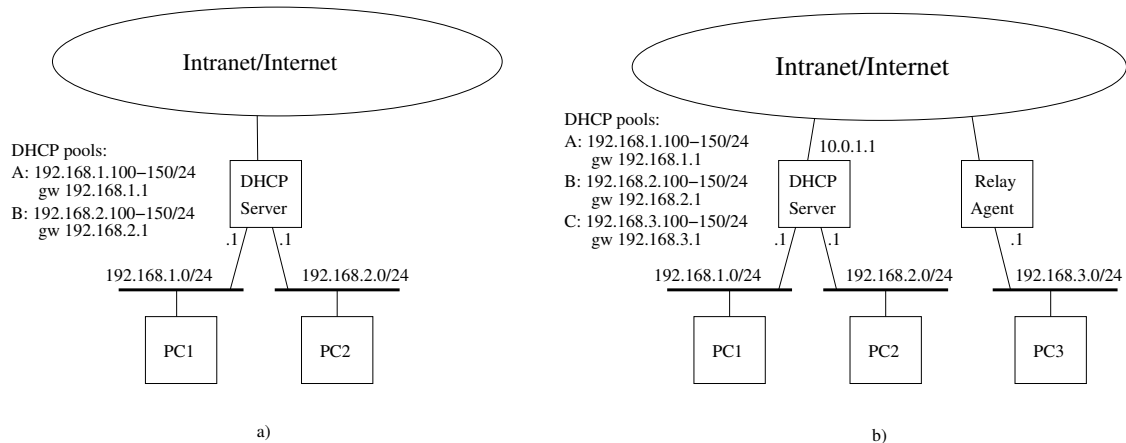

Figure 23.1: Sample DHCP use cases: (a) DHCP server serving local subnets, and (b) serving local and remote subnets.

DHCP servers are typically used to dynamically assign IP settings (IP address, netmask, default gateway, etc.) to hosts on the local subnet, see [fig. 23.1a](#). The server maintains an *address pool* for each served subnet, from which it assigns addresses to DHCP clients currently present on that LAN. Addresses in the pool are maintained dynamically - they are assigned to clients for a configurable time (DHCP *lease time*), and if a client goes away, that address can be reused and assigned to another client.

The DHCP server also hands out configuration settings for *default gateway* and *DNS server(s)*. For local clients as in [fig. 23.1a](#), the DHCP server unit will commonly act as default gateway and DNS server¹ too.

To provide DHCP service on multiple subnets throughout your infrastructure, you could either deploy a DHCP server on each subnet, or you could use DHCP *relay agents* to forward DHCP packets between the remote subnet and a central DHCP server, as shown in [fig. 23.1b](#).

When configuring the server, there is no major difference if the subnet is local or remote – you will simply define which subnets to serve. When the server receives a DHCP message, it will automatically detect which subnet the request originated from and thereby be able to hand out an address from the pool it has defined for that subnet. Up to MAX_DHCP_SUBNETS (64) subnets can be managed by the WeOS DHCP server.

¹A WeOS unit acts as (proxy) DNS server by default, see [section 22.3.4](#).

In addition to handing out addresses dynamically from a pool, it is possible to assign addresses more *specifically* based on the client's *MAC address*, the *client identifier* (client-ID) included in the DHCP messages from the client, or the physical port where the client is connected. More information on this is given in [sections 23.1.2.1](#) and [23.1.5](#).

The DHCP server unit will by default accept incoming DHCP packets on any of its interfaces, including the loopback interface "**lo**". (The exception are those interfaces where a DHCP relay agent has been configured on the local unit, see [section 23.1.5](#) – there DHCP packets will be handled by the relay agent.)

**Hint**

For security purposes you may wish to avoid accepting DHCP packets on some interfaces, e.g., your upstream interface towards the Internet. To block such request you are recommended to configure appropriate *deny* filter rules, e.g., "**filter deny in vlan1 dport 67 proto udp**" to block incoming DHCP request on interface *vlan1*. For more details on the WeOS firewall, see [chapter 33](#).

By default the DHCP server will check that an address is not in use before offering it to a client. In some rare cases it may be useful to disable this.

23.1.2 Available features and scope of configuration

Configuration of DHCP server settings can be done at three levels of scope:

- **Global level:** Settings in the global scope can be seen as default values. They are valid for communication with all DHCP clients, unless overridden by a corresponding setting at subnet or host level.
- **Subnet level:** Settings at the subnet level apply to a specific IP subnet. They override corresponding settings done at global level, but may themselves be overridden by settings at host level. Some settings only apply to the subnet level, e.g., specifying the IP range for the address pool.
- **Host level:** Settings at host level applies to individual DHCP clients. They override corresponding settings at global or subnet level. Some settings only apply to the host level, e.g., specifying the IP address to hand out to a specific host. Assigning IP settings per host is referred to as "static lease", as opposed "dynamic" assignment from a pool.

An exception is classless routes (option 121/249); routes defined at subnet level complements routes defined at global level, and routes defined at host level complements routes defined at subnet and global levels.

Below is a summary of server settings for client configuration and DHCP server features, and the possible level of scope. More details of the individual settings are found in later sections.

Setting	Global	Subnet	Host
Settings for client configuration			
Address pool		X	
Address (individual)			X
Deny service			X
Netmask		X	
Gateway/Router	X ¹	X	X
Name server	X	X	X
Hostname			X
Domain path		X	X
NTP Server		X	X
Log Server	X	X	X
Classless Static Route	X	X	X
TFTP-server address	X		X
TFTP-server name	X		X
TFTP file	X		X
Lease-time		X	X
Other Server settings			
Ping-check	X		
Server-port	X		
Client-port	X		
Preempt static lease			X

¹The gateway/router at global scope level is not used to set an explicit gateway/router; it only affects the default behaviour for assigning gateway/router at subnet or host level, see [section 23.1.2.2](#).

23.1.2.1 IP address assignment

The addresses can either be assigned *dynamically* from an *address pool*, or be assigned statically depending on the client's MAC, its DHCP client identifier, or the port to which it is connected.

- *Address pool*: For each subnet served it is possible to define a pool of addresses for dynamic assignment. The default range is "100-199", e.g., 10.10.2.100-10.10.2.199 on the 10.10.2.0/24 subnet.

It is possible to disable dynamic address allocation using the "**no pool**" syntax in the CLI. This is mostly useful in combination with fixed assignment.

- *Static lease*: Instead of handing out addresses from a dynamic pool, the WeOS DHCP server enables you to assign addresses with more fine grain control. You can match these *host specific assignments*, based on the *MAC address* of the client, the *DHCP Client-ID* provided by the client, or *port* to which the client has connected (DHCP option 82).

The static lease matching method (MAC, Client-id, Option 82) can also be used to *deny* clients an IP address. To specify this feature, use the keyword "**deny**" instead of an IP address in the assignment command.

For more information on how to match incoming DHCP Requests to static leases, see [section 23.1.4](#).

23.1.2.2 Configuration Options other than IP address

In addition to IP address, the WeOS DHCP server allows you configure the following configuration options:

- *Netmask (DHCP Option 1)*: IP netmask is passed to the client in DHCP option 1. By default, the netmask is set to 255.255.255.0.
- *Router IP address (DHCP Option 3)*: The DHCP server will pass information about what router (default gateway) the DHCP client should use. It is possible to tweak router/gateway address assignment, although the default behaviour is likely to work for most setups.
 - *Auto*: By default the DHCP server will automatically fill out a value likely to work for the client.
 - * *Local clients*: For DHCP requests originating on the local subnets, the DHCP server will put its own IP address on that subnet as *gateway* IP address.

- * *Remote clients*: For DHCP requests originating on remote subnets, the DHCP server will put the IP address of the relay agent as *gateway* IP address.

The *Auto* behaviour is set at global scope level (enabled by default), and can be overridden with a specific address at lower levels, see below.

- *No router assignment*: At global level you can change the default behaviour to skip assigning router address (instead of the *Auto* behaviour). This can still be overridden with a specific address at lower levels, see below.
- *Assign specific router address*: You can specify the IP address to be assigned as router/gateway for the DHCP clients. This setting is available at subnet and host scope levels. Disabled by default.
- *DNS Server (DHCP option 6)*: The DHCP server will pass information about what name server(s) the DHCP client should use. By default the DHCP server will provide its own address as name server. This works well in simple setups, as the DHCP server will then act as DNS forwarder and forward any (non-cached) incoming DNS requests to the name-server(s) configured on the unit, see [chapter 22](#)). However, it is possible to tweak the name server assignment.
 - *Auto*: By default the DHCP server will fill out itself as DNS server in the DHCP assignment. This behaviour is achieved by specifying mode *Auto* as name server setting at global level, and to leave the name server unspecified at subnet and host levels.
 - *No DNS server assignment*: To avoid assigning any name server, disable name server at global level, and leave the name server unspecified at subnet and host levels.
 - *Assign specific DNS server(s)*: It is possible to specify up to two DNS servers to be passed to the DHCP client. These name servers can be specified at global, subnet or host level.
- *Log Server (DHCP option 7)*: The DHCP server can be configured to pass up to two *Log Servers* to the DHCP client. (Leaving the setting empty implies that no Log Server is sent to the client.)
- *Domain search path (DHCP option 15)*: The DHCP server can be configured to pass a *domain search path* to the DHCP client. (Leaving the setting empty implies that no domain search path is sent to the client.)

- *NTP Server (DHCP option 42)*: The DHCP server can be configured to pass up to two *NTP Servers* to the DHCP client. (Leaving the setting empty implies that no NTP server is sent to the client.)
- *Lease time (DHCP Option 51)*: The lease time can be configured in range 120-5256000 seconds or "infinite". It defaults to 864000 seconds (10 days).
- *TFTP server address*: The DHCP server can be configured to pass the next-server address *siaddr* in DHCP and BOOTP messages from the DHCP server, i.e., the IP address of a TFTP server (or other type of file transfer server) used by a BOOTP/DHCP client to retrieve a boot file (see below).
- *TFTP server name (DHCP Option 66)*: The DHCP server can be configured to pass the next-server domain name. It can be used to inform BOOTP/DHCP clients about their next-server to download a boot file, as an alternative to the next-server address (see above).

The server name is typically passed within the *sname* field of a BOOTP/DHCP message, but is instead sent as DHCP option 66 if *option overloading* applies or if the client has requested DHCP option 66.

- *TFTP file (DHCP Option 67)*: The DHCP server can be configured to pass the boot filename (as stored at the TFTP server).

The bootfile name is typically passed within the *file* field of a BOOTP/DHCP message, but is instead sent as DHCP option 67 if *option overloading* applies or if the client has requested DHCP option 67.

- *Classless Static Route (DHCP Option 121/249)*: The DHCP server can be configured to pass multiple classless static routes (destination, prefix length and next-hop) to the DHCP client.

DHCP Option 249 is a Microsoft specific variant of option 121. As a server may need to handle clients requesting option 121 and 249, the WeOS DHCP server uses the same setting to control both options. This ensures that routes advertised by options 121 and 249 be identical.

The WeOS DHCP server can be configured with up to 512 classless static routes in total.

23.1.3 General DHCP Server settings

WeOS allows you to configure a set of general DHCP server settings. These are advanced settings, and are primarily of interest to users with special demands. The default values are sufficient in almost all use cases.

- *DHCP Server Listening UDP port*: The DHCP server listens to UDP port 67 by default (in-line with RFC2131[7]). It is possible to set the server port to a different value. That may be of interest in some specific DHCP relay setups, to avoid that the server receives packets directly from clients (in addition to *relayed* packets).

 **Note**

It is possible to configure the WeOS relay agent to forward DHCP messages to non-standard UDP ports on the server, see [chapter 24](#).

- *DHCP Server Source UDP port (client port)*: The DHCP server will send packets with source UDP port 68 by default. It is possible to set the source UDP port to a non-default value.
- *Enable/disable Duplicate Address Detection (ICMP Ping Check)*: Before a DHCP server offers a client an address it will check that no-one is already using that address. The server conducts this *duplicate address detection* mechanism by attempting to "ping" the IP address a couple of time to verify that it gets no response. Disabling "ping check" can speed up address assignment.

The "ping check" mechanism is recommended for robustness and is enabled by default. Only consider disabling "ping-check" if you are using static leases.

 **Warning**

The WeOS DHCP server does **not** store the lease table in persistent storage. Disabling "ping check" can therefore lead to situations where a server reboot causes some host to be assigned an address, which was already assigned to (and in use by) another host.

- *Preemption of static leases*: When replacing a unit, which has been assigned an address according to a static lease (e.g., matching on option 82 or client-id) it is possible to preempt the existing lease.
 - *Option 82 preemption*: When assigning an address to a unit connecting via a specific port (option 82), a WeOS DHCP server assumes that an existing lease should be preempted if it receives a new DHCP Request from that port. That is, a WeOS DHCP server will always preempt static leases when option 82 is used in the matching criteria; this also applies

when combining option 82 with *client-id* as match criteria. Before handing out the address to a new client, the server will run a ping-check to verify that the old client is not active (given that ping-check is enabled).

- *Client-id preemption*: When matching is done based on *client-id* it is possible to configure if the static lease should be preempted or not. The server will still conduct a ping-check before reassigning the address (see comment on "Option 82 preemption" above).
- *MAC address preemption*: The DHCP server will treat requests from the same MAC address as being the same client unit. Thus, preemption is not relevant for static leases matching on MAC addresses.

23.1.4 Matching Static Lease Assignments

You can define specific configuration settings for different hosts (static leases). Up to MAX_STATIC_LEASES (1024) static leases can be configured. Incoming DHCP requests can be matched to a static lease based on several criteria:

- *Client MAC*: You can reserve a specific address to a client with a certain MAC address.
- *Client identifier (option 61)*: You can reserve a specific address to a client including a certain *client-identifier* in its DHCP messages (DHCP option 61[1]). In the DHCP server, you can specify the *client-id* as a hexadecimal sequence (e.g., "01485b392f34bc") or as a text string such as "foobar".

Note

If the *client-id* is specified as a text string, it would match a DHCP option 61 holding a hexadecimal sequence of the corresponding ASCII numbers^a, e.g., "foobar" would match an option 61 holding value "666f6f626172" (hex). In addition, the WeOS DHCP server would accept the same string with a prepended "00"; thus, "foobar" would also match an option 61 holding value "00666f6f626172" (hex).

^aAmerican Standard Code for Information Interchange (ASCII), see e.g. <http://en.wikipedia.org/wiki/ASCII> (accessed May 2009).

Note

A WeOS unit acting as *DHCP client* sends a *client-id* consisting of a concatenation of '01' and 'the MAC address of the interface', see [section 22.2.9](#).

- *Connected Port (option 82)*: The server can be configured to assign a specific address to the client connected to a certain switch port ("one IP per port"). This is useful when you wish to replace a client unit, such as a CCTV camera, and ensure that the new unit gets the same IP as the replaced unit.
- *Combination of connected port (option 82) and client identifier (option 61)*: You may to assign the address based on the combination of option 82 and 61. This can be useful in situations where you have multiple hosts connected to the same port of the (WeOS) relay agent (e.g., via a external hub). As long as the client-id is unique per port on the (WeOS) relay agent, the combination of client-id (option 61) and connected port (option 82) can uniquely identify the host.
- *Other combinations*: Use of other combinations for matching is discouraged. If other combinations are used, the behaviour is undefined.

As described in [chapter 24](#), DHCP relay agents can add information to identify the client's port in a relay information option (DHCP option 82[38]). The DHCP server can then extract relevant information (*circuit-id* and *remote-id*) and use that when assigning the IP address.

The WeOS DHCP server allows for flexible specification of *circuit-id* and *remote-id* (both as hexadecimal sequences and text strings), enabling it to work with relay agents of various vendors. E.g., to make the DHCP server hand out a specific IP address to a client unit attached to WeOS Relay Agent with default settings, the DHCP server can be configured as follows:

- *Circuit-id*: If the client is supposed to connect to Ethernet port 2, then specify "**Eth2**" (string) for the circuit-id. If a slotted WeOS product is used, then specify e.g., "**Eth3/5**" for Ethernet port 5 on slot 3.
- *Remote-id*: The remote-id is optional, but needed to distinguish between relay agents on the same subnet. A WeOS relay agent defaults to using its base MAC² address as remote-id.. E.g., specify "**00077c8209d0**" (hex) for a WeOS relay agent with base MAC `00:07:7c:82:09:d0`.

Note: to assign IP addresses per (local) ports on the DHCP server itself in WeOS v4.33.0, you will need to setup a Relay Agent on the same unit (see [section 23.1.5](#)).

²To find the base MAC of your WeOS unit, see [sections 4.4.2](#) (Web) or [7.3.2](#) (CLI).

 **A note on matching precedence order**

A client request associated with a subnet served by the DHCP server may match multiple static lease match entries, e.g., it may match one entry based on its MAC and another entry based on the port (option 82). Such ambiguities may be mitigated by avoiding use of different types of match criteria (e.g., only use "option 82"). When a client request matches multiple static lease entries, they are evaluated in the following precedence order:

- Matching port (option 82) **and** client-id (option 61) (*first*)
- Matching port (option 82)
- Matching client-id (option 61)
- Matching MAC address
- Assign address from pool (*last*)

23.1.5 Running a DHCP server and relay agent on the same unit

There are situations when you wish to run a DHCP relay agent ([chapter 24](#)) on the same WeOS unit as your DHCP server.

- **IP per port on DHCP server unit:** [Section 23.1.5.1](#) describes how to use a DHCP server and a relay agent to assign IP addresses per port on the DHCP server unit itself.
- **Non-“DHCP snooping” relay agents in switched topologies:** [Section 23.1.5.2](#) explains how to handle non-“DHCP snooping” relay agents in *switched* (as opposed to *routed*) topologies. (An alternative approach is to let the DHCP server listen to a non-default UDP port, see [section 23.1.3.](#))

23.1.5.1 IP per port on local DHCP server ports

With DHCP option 82, a relay agent can inform the DHCP server which port (circuit-id) the client is connected to, thereby enabling the server to assign IP addresses per port. In WeOS, the same approach is used when you wish to hand out IP addresses per port on the DHCP server’s local ports.

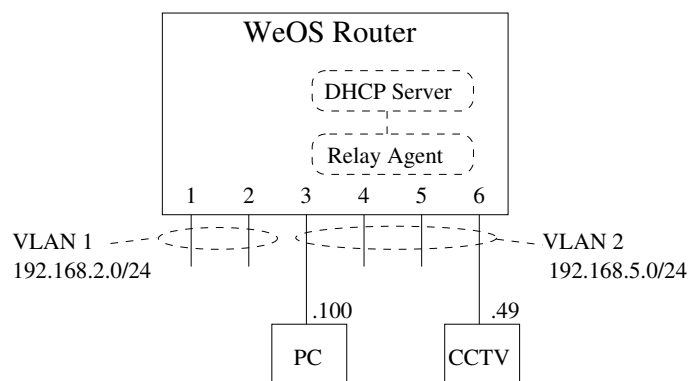



Figure 23.2: Running both a DHCP Server and a DHCP Relay Agent on the same unit enables you to assign IP address per port on the DHCP server unit.

[Fig. 23.2](#) illustrates an example where the WeOS unit is configured to hand out addresses on interface **"vlan2"** (subnet 192.168.5.0/24). Regular hosts, such as the PC, will be assigned their IP addresses from an address pool, but the unit attached to port 6 should always be assigned IP address 192.168.5.49. This can be achieved by configuring a DHCP relay agent on interface **"vlan2"**, and to instruct the relay agent to forward DHCP request to the local DHCP server

(address **"127.0.0.1"**). Relevant parts of the WeOS configuration is listed in [fig. 23.3](#).

 **Example**

```

dhcp-server
  subnet 192.168.5.0/24
    pool 192.168.5.100 192.168.5.199
    lease-time 864000
    netmask 255.255.255.0
    no gateway
    no domain
  end
  host 1
    match option82 circuit-id string "Eth6" remote-id hex 00:07:7c:00:30:b0
    address 192.168.5.49
  end
end

dhcp-relay
  iface vlan2
  server 127.0.0.1
  option82 discard
end

```

Figure 23.3: Configuration example with DHCP relay and server on same unit, here with base-MAC address as Option82 Remote-ID.

The WeOS DHCP relay will by default pass its *base-MAC address*³ as *remote-id* (**"00:07:7c:00:30:b0"** in the configuration example in [fig. 23.3](#)). As the base-MAC is unit specific, this setting will not work if you wish to replace the unit, but keep the same configuration file. In such situations, using **"system-name"** or **"ip"** as *remote-id* is recommended, see [sections 24.2.1](#) (Web) and [24.3.9](#) (CLI) for more information. An example using the system name as *remote-id* is given in [fig. 23.4](#).

³To find the base MAC of your WeOS unit, see [sections 4.4.2](#) (Web) or [7.3.2](#) (CLI).

 **Example**

```
system
  hostname foobar
end

dhcp-server
  subnet 192.168.5.0/24
    pool 192.168.5.100 192.168.5.199
    lease-time 864000
    netmask 255.255.255.0
    no gateway
    no domain
  end
  host 1
    match option82 circuit-id string "Eth6" remote-id string "foobar"
    address 192.168.2.49
  end
end

dhcp-relay
  iface vlan2
  server 127.0.0.1
  option82 discard
  remoteid-type system-name
end
```

Figure 23.4: Configuration example with DHCP relay and server on same unit, here with system hostname as Option82 Remote-ID.

23.1.5.2 Handling non-snooping relay agents in switched topologies

As described in section 24.1.4, use of relay agents to add option 82 information in *switched topologies* is challenging if the relay agents do not support DHCP snooping. A (broadcast) DHCP message from a client will then result in two messages being forwarded towards the DHCP server - one *relayed* message including option 82 information, and one *regular* message being *switched* and lacking option 82.

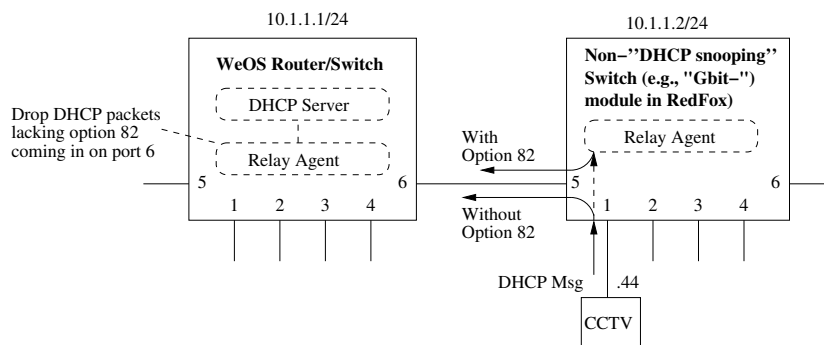

Figure 23.5: A non-“DHCP snooping” relay agent (right unit) will likely result in multiple “copies” of the DHCP messages. This can be handled by running a DHCP Relay Agent also the DHCP server unit (left unit).

Fig. 23.5 illustrates the situation. All ports are assumed to be on the same VLAN (e.g., VLAN 1)

1. A broadcast DHCP message is sent by the PC on port 1 of the non-snooping switch. That packet is forwarded onto all ports on the same VLAN including port 5 towards the DHCP server.
2. The packet is also processed by the relay agent process, which adds option 82 information and relays the message (unicast) towards the DHCP server.
3. If both DHCP requests would reach the DHCP server, it is likely that the PC will be handed an address from the pool rather than an address dedicated for that specific port. Or possibly the PC will get multiple responses to its request.

In WeOS you can handle this by running a DHCP relay agent on the DHCP server unit. The relay agent can be configured to drop DHCP packets not including option 82, thus only the relayed packet will be forwarded to the DHCP server process.

Below sample configurations for the DHCP server and DHCP relay agent units are shown. The CCTV connected to port 1⁴ of the (non-snooping) relay agent should be assigned IP address 10.1.1.44/24.



Hint

An alternative approach is to let the DHCP server listen to a non-default UDP port, see [section 23.1.3](#). Then the DHCP relay agent must be configured to send to this UDP port when relaying packets to the server.



Example

```
-- DHCP Server Unit (IP 10.1.1.1/24)
dhcp-server
  subnet 10.1.1.0/24
    pool 10.1.1.100 10.1.1.199
    lease-time 864000
    netmask 255.255.255.0
    gateway 10.1.1.1
    no domain
  end
  host 1
    match option82 circuit-id string "Eth1" remote-id string "10.1.1.2"
    address 10.1.1.44
  end
end

dhcp-relay
  iface vlan1
  server 127.0.0.1
  option82 discard
  remoteid-type ip
  port 6
    option82 require
  end
end

-- DHCP Relay Agent Unit (IP 10.1.1.2/24)
dhcp-relay
  iface vlan1
  server 10.1.1.1
  option82 discard
  remoteid-type ip
end
```

⁴If the relay agent unit is a RedFox Industrial, the port labels would be written in slot/id form (1/1, 1/2, etc.). The server configuration would then reflect this, e.g., **"match option82 circuit-id string "Eth1/2" remote-id string "10.1.1.2"**" if the CCTV is connected to port 1/2.

23.2 Configuring DHCP Server Settings via the Web

The Web interface provides management of DHCP Server.

23.2.1 DHCP Server settings

Menu path: Configuration ⇒ Network (IP) ⇒ DHCP-Server

DHCP Server

Enabled



Show Advanced Settings ▾

Subnets

Subnet	Pool Start	Pool End	Lease Time	Gateway	Name Servers	Domain	
192.168.2.0	192.168.2.100	192.168.2.149	864000	192.168.2.1	192.168.3.2 192.168.7.2	mydomain.com	
192.168.3.0	192.168.3.100	192.168.3.199	864000	192.168.3.1	192.168.3.2 192.168.7.2	mydomain.com	

Static DHCP

ID	Static Lease	Type	Identifier	Hostname	Override Subnet	Preempt	
1	192.168.2.40	mac	12:34:56:78:9a:bc		✓	⊖	
2	192.168.2.41	client-id	x-server		⊖	⊖	
3	192.168.2.42	option-82-cid	Eth1		⊖	⊖	
		option-82-rid	Switch1				

Enabled	Check the box to enable the DHCP server. If you have a JavaScript enabled browser the other settings will not be displayed unless you check this box.
Subnets	Lists the configured DHCP subnets To add a Subnet click on the New subnet button below the table. Click on the Edit icon () to edit the settings for a specific Subnet. Clicking the edit icon or the "New Subnet" button will take you the "Create/Edit DHCP Subnet" page, see section 23.2.2 .
Static DHCP	The static leases for this subnet. To add a static lease, click the New Lease button. Click on the Edit icon () to edit the settings for an existing lease. Clicking the edit icon or the "New Lease" button will take you to the "Create/Edit DHCP Host Settings" page, see section 23.2.3 .

23.2.1.1 Advanced DHCP Server settings

Menu path: Configuration ⇒ Network (IP) ⇒ DHCP-Server ⇒ Advanced Settings

DHCP Server



Enabled

Gateway	<input checked="" type="checkbox"/>						
Name Server	Auto						
Ping Check	<input checked="" type="checkbox"/>						
Server Port	67						
Client Port	68						
Boot	Server Address						
	Server Name						
	File						
Log Servers							
Classless Static Routes	<table border="1"> <thead> <tr> <th>Network</th> <th>Length</th> <th>Router</th> </tr> </thead> <tbody> <tr> <td>192.168.6.0</td> <td>24</td> <td>192.168.5.2</td> </tr> </tbody> </table>	Network	Length	Router	192.168.6.0	24	192.168.5.2
Network	Length	Router					
192.168.6.0	24	192.168.5.2					

Hide Advanced Settings▲

Apply Cancel

Gateway	Specify whether default behaviour is to assign (or not assign) default router/gateway to a host.
Name Server	The default (DNS) name server option handed to a host.
Ping Check	Enables/disables the ICMP ping check. By default the DHCP server will check that an address is not in use before offering it to a client. In some rare cases it may be useful to disable this. Default enabled
Continued on next page	



Continued from previous page	
Server Port	Set server listening port, default 67
Client Port	Set client port, default 68
Boot Server Address	IP address for server from which the client should retrieve the boot file.
Boot Server Name	DNS name for server from which the client should retrieve the boot file.
Boot File	Name of the boot file to retrieve from boot server.
Log Servers	The global log server option to be handed out to all DHCP clients. Can be overridden in subnet or host configuration.
Classless Static Routes	Routes defined here will be sent as DHCP options 121 and 249 to the client. Up to 512 routes can be configured in total, counting global, subnet and host contexts.
	Click this icon to add a classless static route.
	Click this icon to delete a classless static route.

23.2.2 Create/Edit DHCP Subnet Settings

Menu path: Configuration ⇒ Network (IP) ⇒ DHCP-Server ⇒ New Subnet



Menu path: Configuration ⇒ Network (IP) ⇒ DHCP-Server ⇒  (Subnet)

Subnet 192.168.3.0

Subnet	192.168.3.0		
Address Pool	<input checked="" type="checkbox"/>	<input type="text" value="192.168.3.80"/>	- <input type="text" value="192.168.3.90"/>
Lease Time	<input type="text" value="10 Days"/> ▼		
Netmask	<input type="text" value="255.255.255.0"/>		
Default Gateway	<input type="text" value="192.168.3.1"/>		
Name Servers	<input type="text" value="192.168.3.2"/>		
	<input type="text" value="192.168.3.8"/>		
Log Servers	<input type="text" value="192.168.3.5"/>		
	<input type="text"/>		
NTP Servers	<input type="text" value="192.168.3.9"/>		
	<input type="text"/>		
Domain	<input type="text" value="my.domain.com"/>		
Classless Static Routes	Network	Length	Router
	<input type="text" value="0.0.0.0"/>	<input type="text" value="0"/>	<input type="text" value="192.168.3.1"/> 
	<input type="text" value="192.168.7.0"/>	<input type="text" value="24"/>	<input type="text" value="192.168.3.3"/> 
			

On this page you can change the settings for the Subnet.

Address Pool	IP address pool from which the DHCP server will hand out leases
Continued on next page	





Continued from previous page	
Lease Time	DHCP address lease time (seconds) for addresses handed out to DHCP clients
Netmask	The netmask option handed to DHCP clients.
Default Gateway	The IP default gateway (default router) option handed to DHCP clients.
Name Servers	The (DNS) name server option handed to DHCP clients.
Log Servers	The log server option handed to DHCP clients.
NTP Servers	The time server (NTP) option handed to DHCP clients.
Domain	Domain name search path option handed to DHCP clients
Classless Static Routes	Routes defined here will be sent as DHCP options 121 and 249 to the client. Up to 512 routes can be configured in total, counting global, subnet and host contexts.
	Click this icon to add a classless static route.
	Click this icon to delete a classless static route.

23.2.3 Create/Edit DHCP Host Settings



Menu path: Configuration ⇒ Network (IP) ⇒ DHCP-Server ⇒ New Lease

Menu path: Configuration ⇒ Network (IP) ⇒ DHCP-Server ⇒  (Static DHCP)

Static Lease 1

Id	1		
Lease	Address	192.168.3.101	
Rule 1	Option 82 Circuit Id		
	Eth7	Hex	<input type="checkbox"/>
Rule 2	Option 82 Remote Id		
	relay_1	Hex	<input type="checkbox"/>
Rule 3	Client ID		
	client1	Hex	<input type="checkbox"/>
Hostname	<input type="text"/>		
Domain	<input type="text"/>		
Lease Time	Auto		
Gateway	<input type="text"/>		
Name Servers	<input type="text"/>		
	<input type="text"/>		
Log Servers	<input type="text"/>		
	<input type="text"/>		
NTP Servers	<input type="text"/>		
	<input type="text"/>		
Boot	Server Address	<input type="text"/>	
	Server Name	<input type="text"/>	
	File	<input type="text"/>	
Preempt	Disabled		
Classless Static Routes	Network	Length	Router
			

On this page you can change the settings for the Host.

Lease	IP address for this lease. If left empty the DHCP server will prohibit the host to be served.
Rule 1-3	Specify up to 3 match types for this host.
Hostname	Sets the hostname that the server will hand out to this host.
Domain	Specify the domain name search path option for this host.
Lease Time	DHCP address lease time (seconds) for this host.
Default Gateway	The IP default gateway (default router) option handed to this host.
Name Servers	The (DNS) name server option handed to this host.
Log Servers	The log server option handed to this host.
NTP Servers	The time server (NTP) option handed to this host.
Boot Server Address	Address of the TFTP server to hand out to this host.
Boot Server Name	Domain name of the TFTP server to hand out to this host.
Boot File	File (at the TFTP server) to hand out to this host.
Classless Static Routes	Routes defined here will be sent as DHCP options 121 and 249 to the client. Up to 512 routes can be configured in total, counting global, subnet and host contexts.
	Click this icon to add a classless static route.
	Click this icon to delete a classless static route.

23.3 Configuring DHCP Server Settings via the CLI

Command	Default	Section
<u>Configure DHCP Server</u>		
[no] dhcp-server	Disabled	Section 23.3.1
[no] enable	Enabled	Section 23.3.2
[no] ping-check	Enabled	Section 23.3.3
[no] gateway [auto]	Auto	Section 23.3.4
[no] name-server <auto IPADDR[,IPADDR]>	Auto	Section 23.3.5
[no] log-server <IPADDR[,IPADDR]>	Disabled	Section 23.3.6
[no] route <NETWORK/LEN GATEWAY>	Disabled	Section 23.3.7
[no] server-port <UDPPORT>	67	Section 23.3.8
[no] client-port <UDPPORT>	68	Section 23.3.9
[no] server-address <IPADDR>	Disabled	Section 23.3.10
[no] server-name <DOMAINNAME>	Disabled	Section 23.3.11
[no] file <FILENAME>	Disabled	Section 23.3.12
[no] host [INDEX]	1	Section 23.3.13
[no] match <mac <MACADDR> clientid <hex string> <CLIENTID> option82 [remote-id <hex string> <REMOTEID>] option82 [circuit-id <hex string> <CIRCUITID>]		Section 23.3.14
[no] address <IPADDR deny>	Disabled	Section 23.3.15
[no] gateway <IPADDR>	Disabled	Section 23.3.16
[no] name-server <IPADDR>	Disabled	Section 23.3.17
[no] log-server <IPADDR>	Disabled	Section 23.3.18
[no] route <NETWORK/LEN GATEWAY>	Disabled	Section 23.3.19
[no] hostname <HOSTNAME>	Disabled	Section 23.3.20
[no] domain <DOMAINNAME>	Disabled	Section 23.3.21
[no] ntp-server <IPADDR>	Disabled	Section 23.3.22
[no] lease-time <infinite 120-5256000>	864000	Section 23.3.23
[no] server-address <IPADDR>	Disabled	Section 23.3.10
[no] server-name <DOMAINNAME>	Disabled	Section 23.3.11
[no] file <FILENAME>	Disabled	Section 23.3.12
[no] preempt	Disabled	Section 23.3.24

Continued on next page

Continued from previous page

Command	Default	Section
[no] subnet <IPADDR[/LEN] IPADDR [MASK]>	/24	Section 23.3.25
[no] netmask <NETMASK>		Section 23.3.26
[no] pool <IPADDR_START> <NUM IPADDR_END>	Auto ¹	Section 23.3.27
[no] gateway <IPADDR>	Empty ²	Section 23.3.16
[no] name-server <IPADDR>[,<IPADDR>]	Empty ²	Section 23.3.17
[no] log-server <IPADDR>[,<IPADDR>]	Empty	Section 23.3.18
[no] route <NETWORK/LEN GATEWAY>	Disabled	Section 23.3.19
[no] domain <DOMAINNAME>	Disabled	Section 23.3.21
[no] ntp-server <IPADDR>	Disabled	Section 23.3.22
[no] lease-time <infinite 120-5256000>	864000	Section 23.3.23
<u>View DHCP Server Status</u> show dhcp-clients		Section 23.3.28

23.3.1 Manage DHCP Server

Syntax [no] dhcp-server

Context [Global Configuration](#) context

Usage Create, modify or remove a DHCP Server.

Enter DHCP Server Configuration context. If this is a new DHCP server, the DHCP server is created. As a side-effect, a *caching* (DNS) name server is started, which forwards incoming DNS requests to the DNS server configured for the switch (see [chapter 22](#)).

Use **"no dhcp-server"** to remove an existing DHCP server.

Use **"show dhcp-server"** to list all settings of a DHCP server. Alternatively, you can run the **"show"** command from within the DHCP Server Configuration context.

Default values Disabled (No DHCP server configured)

¹A pool may be created automatically. See [Section 23.3.27](#).

²Empty values have special meaning here. See [Section 23.3.16](#) and [Section 23.3.17](#).

23.3.2 Disable DHCP Server

Syntax [no] enable

Context DHCP Server Configuration context

Usage Enable/disable the DHCP server. Useful to disable a fully setup DHCP server before deployment, the configuration will remain dormant while disabled.

Use **"no enable"** to disable the DHCP server (without losing the DHCP server configuration) and **"enable"** to enable the DHCP server.

Use **"show enable"** to show whether the DHCP server is configured enabled or disabled.

Default values Enabled

23.3.3 Disable ICMP "ping" Check

Syntax [no] ping-check

Context DHCP Server Configuration context

Usage Enable/disable the ICMP ping check. By default the DHCP server will check that an address is not in use before offering it to a client. In some rare cases it may be useful to disable this.

Use **"no ping-check"** to disable the ping-check mechanism, and **"ping-check"** to enable it.

Run **"show ping-check"** to show whether the ping-check mechanism is configured enabled or disabled.

Default values Enabled

23.3.4 Global Gateway assignment setting

Syntax [no] gateway [auto]

Context DHCP Server Configuration context

Usage Control the default behaviour of default gateway (option 3) assignment.

- *Auto*: The **"gateway auto"** setting achieves default behaviour that the unit's own IP address (local DHCP clients) or the DHCP relay agent's IP address (remote DHCP clients) is assigned as default gateway.

- *Disabled* The **"no gateway"** setting achieves the default behaviour that no default gateway is assigned to DHCP clients.

This setting can be overridden by setting a specific IP address as default gateway at subnet/host level ([section 23.3.16](#)).

Use **"show gateway"** to show the current setting.

Default values Auto

23.3.5 Global Domain Name Server assignment setting

Syntax [no] name-server <auto|IPADDR[,IPADDR]>

Context DHCP Server Configuration context

Usage Control the default behaviour of (DNS) name server (option 6) assignment.

- *Auto*: The **"name-server auto"** setting achieves default behaviour that the unit's own IP address is assigned as name server.
- *Disabled*: The **"no name-server"** setting achieves the default behaviour that no name server is assigned to DHCP clients.
- *Specific name server*: The **"name-server IPADDRESS-LIST"** setting can be used to specify specific name server(s) to assign. For example, use **"name-server 192.168.2.11"** to assign 192.168.2.11 as name server.

This setting can be overridden by setting a specific IP address as default gateway at subnet/host level ([section 23.3.17](#)).

Use **"show name-server"** to show the current setting.

Default values Auto

23.3.6 Global Log Server assignment setting

Syntax [no] log-server <IPADDR[,IPADDR]>

Context DHCP Server Configuration context

Usage Control the default behaviour of log server (option 7) assignment.

- *Disabled*: The **"no log-server"** setting achieves the default behaviour that no log server is assigned to DHCP clients.

- *Specific log server:* The **"log-server IPADDRESS-LIST"** setting is used to specify specific log server(s) to assign. For example, use **"log-server 192.168.2.11"** to assign 192.168.2.11 as log server.

This setting can be overridden by setting a specific IP address as log server at subnet/host level ([section 23.3.18](#)).

Use **"show log-server"** to show the current setting.

Default values Disabled

23.3.7 Global Classless Route setting

Syntax [no] route <NETWORK/LEN GATEWAY>

Context [DHCP Server Configuration](#) context

Usage Configure classless route(s) assigned to any DHCP client served by this DHCP server. Routes defined here will be sent as DHCP options 121 and 249.

Use **"route NETWORK/LEN GATEWAY"** to add a route included to any DHCP client served by this server.

Use **"no route NETWORK/LEN GATEWAY"** to remove a specific route, and **"no route"** to remove all routes in this context. Use **"no route all"** to remove all routes in all DHCP contexts.

Use **"show route"** to show configured routes in this context.

Routes configured in specific subcontexts (subnet and/or host context, see [section 23.3.19](#)) will complement the routes defined here in the global context.

Default values Disabled

Examples See [section 23.3.19](#) for an example.

23.3.8 DHCP Server Listening UDP port

Syntax [no] server-port <UDPPORT>

Context [DHCP Server Configuration](#) context

Usage Set DHCP Server listening (UDP) port in range 1..65535. By default the server listens to UDP port 67. Use **"server-port UDPPORT"** to set a non-default UDP port to listen on. See also [section 24.3.5](#) for the corresponding DHCP relay agent setting.

Use **"no server-port"** to reset to default value (port 67).

Use **"show server-port"** to show current server-port settings.

Default values 67

23.3.9 DHCP Server Source/Client UDP port

Syntax [no] client-port <UDPPORT>

Context [DHCP Server Configuration](#) context

Usage Set DHCP Server source (UDP) port in range 1..65535. By default the server sends DHCP messages with source UDP port 68. Use **"client-port UDPPORT"** to set a non-default UDP port to send from.

Use **"no client-port"** to reset to default value (port 68).

Use **"show client-port"** to show current client-port settings.

Default values 68

23.3.10 Next Server Address – BOOTP "siaddr"

Syntax [no] tftp-server <IPADDR>

Context [DHCP Server Configuration](#) or [DHCP Server Host Configuration](#) context

Usage Set the next-server address *siaddr* in DHCP and BOOTP messages from the DHCP server, i.e., the IP address of a TFTP server (or other type of file transfer server) used by a BOOTP/DHCP client to retrieve a boot file.



Note

Using the **"tftp-server"** command in [DHCP Server Configuration](#) will apply to all DHCP messages from the server. Using the **"tftp-server"** command in [DHCP Server Host Configuration](#) will apply only to that static lease entry.

Use **"no tftp-server"** to remove a configured next-server address.

Use **"show tftp-server"** to show the next-server setting.

Default values Disabled

23.3.11 Next Server Name – BOOTP "sname", DHCP Option 66

Syntax [no] tftp-server-name <DOMAINNAME>

Context [DHCP Server Configuration](#) or [DHCP Server Host Configuration](#) context

Usage Set the next-server domain name. It can be used to inform BOOTP/DHCP clients about their next-server to download a boot file, as an alternative to the next-server address (see [section 23.3.10](#)).

The server name is typically passed within the *sname* field of a BOOTP/DHCP message, but is instead sent as DHCP option 66 if *option overloading* applies or if the client has requested DHCP option 66.



Note

Using the **"tftp-server-name"** command in [DHCP Server Configuration](#) will apply to all DHCP messages from the server. Using the **"tftp-server-name"** command in [DHCP Server Host Configuration](#) will apply to that static-lease entry.

Use **"no tftp-server-name"** to remove a configured next-server name.

Use **"show tftp-server-name"** to show the next-server name setting.

Default values Disabled

23.3.12 Bootfile Name – BOOTP "file", DHCP Option 67

Syntax [no] bootfile <FILENAME>

Context [DHCP Server Configuration](#) or [DHCP Server Host Configuration](#) context

Usage Set the boot filename (as stored at the TFTP server).

The bootfile name is typically passed within the *file* field of a BOOTP/DHCP message, but is instead sent as DHCP option 67 if *option overloading* applies or if the client has requested DHCP option 67.



Note

Using the **"bootfile"** command in [DHCP Server Configuration](#) will apply to all DHCP messages from the server. Using the **"bootfile"** command in [DHCP Server Host Configuration](#) will apply to that static-lease entry.

Use **"no bootfile"** to remove a configured bootfile name.

Use **"show bootfile"** to show the next-server name setting.

Default values Disabled

23.3.13 Configure Host Entry (Static Lease)

Syntax [no] host [INDEX]

Context DHCP Server Host Configuration context

Usage Enter the DHCP Server Host Configuration to specify host specific DHCP Server settings, i.e., static lease settings. This is typically used to configure a static lease based on MAC, Client-ID or port ID (i.e., DHCP Option 82). Up to 1024 can be configured. Each entry is given an index (default 1), e.g., **"host 3"** will enter the DHCP Server Host Configuration for entry number 3; the entry will be created if it does not yet exist.

Use **"no host"** to remove all configured static lease entries, and use **"no host <INDEX>"** to remove a specific static lease entry (e.g. **"no host 3"**).

Use **"show host"** to show a list configured static lease entries, and use **"show host <INDEX>"** to show information on a specific static lease. Alternatively, you can run the **"show"** command within the DHCP Server Host Configuration context of that specific static lease.

Default values Default index is 1.

23.3.14 Configure Static Lease Match Setting

Syntax [no] match <mac <MACADDR> | clientid <hex|string> CLIENTID> | option82 [remote-id <hex|string> <REMOTEID>] | option82 [circuit-id <hex|string> <CIRCUITID>]>

Context DHCP Server Host Configuration context

Usage Specify the match type (mac, clientid or option82) to identify the host for this entry, e.g., **"match mac 12:34:56:78:9a:bc:de"**.

Use **"no match mac <MACADDR>"**, **"no match clientid <hex|string> <CLIENTID>"**, or **"no match option82 <...>"** to remove a specific match setting. Use **"no match"** to remove all match settings.

Use **"show match"** to show the current match setting for this static lease.

Default values Not applicable. [section 23.3.25](#).

23.3.15 Configure Host IP Address or Deny Service

Syntax [no] address <IPADDRESS|deny>

Context [DHCP Server Host Configuration](#) context

Usage Specify the IP address to assign to this host, e.g., **"address 192.168.1.51"**.

Note

To hand out the specified address (e.g., **"192.168.1.51"**) the DHCP server must also be configured to serve the associated IP subnet, see [section 23.3.25](#) for information on the **"subnet"** command. Other IP settings (netmask, default gateway, etc.) will be inherited from settings of the associated subnet.

Use **"address deny"** to prohibit the host to be served by this DHCP server.

A host must either be assigned an IP address or explicitly be denied an address. **"no address"** is not a valid setting, i.e., then the host entry will not be activated.

Use **"show address"** to show the current address setting.

Default values None

23.3.16 Configure DHCP Server Default Gateway Option

Syntax [no] gateway <IPADDRESS>

Context [DHCP Server Subnet Configuration](#) or [DHCP Server Host Configuration](#) context

Usage Specify the IP default gateway (default router) option for leases handed to DHCP clients. A single default gateway can be specified, e.g., use **"gateway 192.168.2.11"** to assign 192.168.2.11 as default gateway.

If no default gateway is specified, the setting specified at higher level (global or subnet) specifies what IP address to assign as default gateway, see [section 23.3.4](#).

Note

When acting as router for local DHCP clients, please remember to enable routing on this unit ([chapter 22](#)) and enable appropriate NAT and firewall rules if necessary ([chapter 33](#)).

Use **"no gateway"** to remove any statically configured default gateway option.

Use **"show gateway"** to list the gateway option settings.

Default values Empty, this means default gateway assignment depends on gateway setting at higher level (global or subnet).

23.3.17 Configure DHCP Server Name Server Option

Syntax [no] name-server <IPADDRESS>[,<IPADDRESS>]

Context [DHCP Server Subnet Configuration](#) or [DHCP Server Host Configuration](#)
context

Usage Specify name server (DNS) options for leases handed to DHCP clients. Up to two DNS name servers can be specified, either as comma separated IP addresses on the command line, or by repeating the command for each address.

Use **"no name-server"** to remove all configured name server DHCP options.

If no name server is specified, the setting specified at higher level (global or subnet) specifies what name server(s) to assign to DHCP clients, see [section 23.3.5](#).

Use **"show name-server"** to list DNS name server option settings.

Default values Empty, this means name server assignment depends on name server setting at higher level (global or subnet).

23.3.18 Configure DHCP Server Log Server Option

Syntax [no] log-server <IPADDRESS>[,<IPADDRESS>]

Context [DHCP Server Subnet Configuration](#) or [DHCP Server Host Configuration](#)
context

Usage Specify log server options for leases handed to DHCP clients. Up to two log servers can be specified, either as comma separated IP addresses on the command line, or by repeating the command for each address.

Use **"no log-server"** to remove all configured log server DHCP options.

If no log server is specified, the setting specified at higher level (global or subnet) specifies what log server(s) to assign to DHCP clients, see [section 23.3.6](#).

Use **"show log-server"** to list log server option settings.

Default values Empty, this means log server assignment depends on log server setting at higher level (global or subnet).

23.3.19 Configure Classless Route setting

Syntax [no] route <NETWORK/LEN GATEWAY>

Context [DHCP Server Subnet Configuration](#) or [DHCP Server Host Configuration](#) context

Usage Configure classless route(s) assigned to DHCP clients in this subnet or a specific host. Routes defined here will be sent as DHCP options 121 and 249.

Use **"route NETWORK/LEN GATEWAY"** to add a route included in the DHCP Offer.

Use **"no route NETWORK/LEN GATEWAY"** to remove a specific route, and **"no route"** to remove all routes in this context.

Use **"show route"** to show configured routes in this context.

Routes configured in specific subcontexts (subnet and/or host) will complemented the routes defined in the [DHCP Server Configuration](#) context, see [section 23.3.7](#).

Default values Disabled

Examples

Below is an example where the server hands out a three routes to DHCP clients on subnet *192.168.5.0/24*.

Example

```
server:/#> configure
server:/config/#> dhcp-server
server:/config/dhcp-server/#> subnet 192.168.5.0/24
server:/config/dhcp-server/subnet-192.168.5.0/#> route 0.0.0.0/0 192.168.5.1
server:/config/dhcp-server/subnet-192.168.5.0/#> route 192.168.6.0/24 192.168.5.2
server:/config/dhcp-server/subnet-192.168.5.0/#> route 192.168.7.0/24 192.168.5.3
server:/config/dhcp-server/subnet-192.168.5.0/#> leave
server:/#>
```

If clients are capable of applying DHCP option 121 (or 249), all these three routes (in addition to local subnet `192.168.5.0`) will appear in the client's routing table. The example below shows the result on a WeOS unit configured as DHCP client (see [section 22.2.11](#)).

Example

```
client:/#> sh ip route
S - Static | C - Connected | K - Kernel route | > - Selected route
O - OSPF | R - RIP | [Distance/Metric] | * - Active route

S>* 0.0.0.0/0 [1/0] via 192.168.5.1, vlan1
C>* 127.0.0.0/8 is directly connected, lo
C>* 192.168.5.0/24 is directly connected, vlan1
S>* 192.168.6.0/24 [1/0] via 192.168.5.2, vlan1
S>* 192.168.7.0/24 [1/0] via 192.168.5.3, vlan1
client:/#>
```

23.3.20 Configure Host Hostname

Syntax [no] hostname <HOSTNAME>

Context DHCP Server Host Configuration context

Usage Specify the hostname e.g., "**hostname doorcamera**".

Sets the hostname that the server will hand out to this host. The command "**no hostname**" will remove the hostname from this host.

Use "**show hostname**" to show the current hostname setting.

Default values Disabled

23.3.21 Configure Domain Name Option

Syntax [no] domain <DOMAIN>

Context [DHCP Server Subnet Configuration](#) or [DHCP Server Host Configuration](#) context

Usage Specify the domain name search path option for leases handed to DHCP clients. A single domain name option can be specified.

Use **"no domain"** to disable this option.

Use **"show domain"** to list domain name option settings.

Default values Disabled, the domain name option will not be used.

23.3.22 Configure NTP Server Option (DHCP Option 42)

Syntax [no] ntp-server <IPADDR>

Context [DHCP Server Subnet Configuration](#) or [DHCP Server Host Configuration](#) context

Usage Specify the NTP-server option (DHCP option 42) for leases handed to DHCP clients, e.g., **"ntp-server 192.168.1.3"**. Up to two NTP servers can be specified.

Use **"no ntp-server <IPADDR>"** to remove a specific NTP server, or **"no ntp-server"** to disable all NTP server options.

Use **"show ntp-server"** to list NTP-server option settings.

Default values Disabled, the NTP-server option will not be used.

23.3.23 Configure DHCP Server Lease Time

Syntax [no] lease-time <infinite|120-5256000>

Context [DHCP Server Subnet Configuration](#) or [DHCP Server Host Configuration](#) context

Usage Specify the DHCP address lease time (seconds) for addresses handed out to DHCP clients.

Use values in range **"120-5256000"** to give lease-time in seconds (e.g., **"lease-time 600"** for 10 minutes), and use the special keyword **"infinite"** to denote an infinite lease time.

Use **"no lease-time"** to reset the lease time setting to its default value.

Use **"show lease-time"** to show the current lease-time setting.

Default values 864000 seconds (i.e., 10 days)

23.3.24 Lease preemption (Client-ID)

Syntax [no] preempt

Context DHCP Server Host Configuration context

Usage Enable/disable lease preemption. This setting only applies when the static lease matches on client-id (option 61), see [section 23.1.3](#).

Use command **"preempt"** to enable lease preemption for this host entry.

Use command **"no preempt"** to disable lease preemption for this host entry.

Use command **"show preempt"** to show the current lease preemption setting for this host.

Default values Disabled (i.e., preemption is disabled for leases matching on client-id)

23.3.25 Configure DHCP Server Subnet

Syntax [no] subnet <IPADDR[/LEN] | IPADDR [NETMASK]>

Context DHCP Server Configuration context

Usage Specify a subnet for which the DHCP server will hand out IP addresses, and enter the DHCP Server Subnet Configuration for that subnet. Optionally, the subnet netmask can be specified as a prefix length or as a netmask, with **"/24"** (**"255.255.255.0"**) as default. It can later be changed with the **"netmask"** command, see [section 23.3.27](#).

Use **"no subnet"** to remove all configured subnets, and use **"no subnet IPADDR"** to remove a specific subnet.

Use **"show subnet"** to show a list configured subnets for the DHCP server, and use **"show subnet IPADDR"** to show information on a specific subnet (alternatively, you can run the **"show"** command within the DHCP Server Subnet Configuration context of that specific subnet).

The DHCP server can handle up to 64 subnets.

Default values Default prefix length is 24 (i.e., netmask 255.255.255.0).

23.3.26 Configure DHCP Subnet Netmask

Syntax [no] netmask <NETMASK>

Context DHCP Server Subnet Configuration context

Usage Specify/modify the netmask for the subnet to serve, e.g.,
"netmask 255.255.128.0".

Use "no netmask" to reset the netmask to its default value.

Use "show netmask" to show the current netmask setting.

Default values The netmask defaults to "255.255.255.0", however, a different netmask can be specified in the "subnet" command, see [section 23.3.25](#).

23.3.27 Configure DHCP Server Address Pool

Syntax [no] pool <IPADDRESS_START> <NUM|IPADDRESS_END>

Context DHCP Server Subnet Configuration context

Usage Specify the IP address pool from which the DHCP server will hand out leases. The *end* of the address range can be specified as an IP address ("IPADDRESS_END"), or as a number ("NUM"). "NUM" specifies the number of addresses in the pool, thus "IPADDRESS_END" is computed as "IPADDRESS_START + NUM - 1".

Use "no pool" to disable dynamic address assignment. When disabled, only static host entries are allowed in the range defined by the subnet itself and the netmask option.

Use "show pool" to see the IP addresses in the pool.

Default values A pool based on the configured subnet is automatically setup when creating a new DHCP subnet.

23.3.28 Show list of current DHCP clients

Syntax show dhcp-clients

Context Admin Exec context

Usage Show list of current DHCP clients.

Default values Not applicable

Example

```
example:/#> show dhcp-clients  
Lease Time  MAC Address      IP Address      Hostname      Client ID  
=====
```

Lease Time	MAC Address	IP Address	Hostname	Client ID
864000	00:07:7c:8a:e2:41	192.168.2.109	*	01:00:07:7c:8a:e2:41

```
example:/#>
```

23.4 Feature Parameters

MAX_DHCP_SUBNETS	64
MAX_STATIC_LEASES	1024
MAX_DHCP_ROUTES_TOTAL	512

Chapter 24

DHCP Relay Agent

This chapter describes WeOS *DHCP Relay Agent* support. For information on WeOS *DHCP Server* support, see [chapter 23](#).

DHCP Relay Agents relay DHCP messages between DHCP clients on a local LAN to a central DHCP Server, usually located on a remote network. The two most common reasons for using DHCP relay agents are:

- *Centralised management*: Deploying and managing a DHCP server on every LAN in your network is cumbersome. By use of relay agents, a central DHCP server can be used, and the management effort is substantially reduced. Furthermore, if the relay agent is located in a router or switch on the local LAN, there is no additional equipment cost.
- *Assigning IP address per port (DHCP Option 82)*: In some topologies, you may wish to assign IP addresses based on the switch port a DHCP client connects to. By running a DHCP Relay Agent in the local switch/router, it can include port information when forwarding the DHCP messages (DHCP Option 82).

For redundancy purposes, the WeOS DHCP Relay Agent enables you to specify up to two DHCP servers, to which the Relay Agent forwards incoming DHCP requests.

In case you wish to hand out addresses per port on the *DHCP server* unit (as opposed to the *DHCP relay agent*), WeOS allows you to achieve this by running a relay agent on the DHCP server unit, see the chapter on DHCP server ([section 23.1.5](#)).

24.1 Overview of DHCP Relay Agent Support

The table below lists the features available in the WeOS DHCP Relay Agent.

Feature	Web	CLI	General Description
<u>General DHCP Relay settings</u>			
Enable/disable Relay Agent	X	X	Section 24.1.1
Define interfaces to serve	X	X	-"-
DHCP server IP address	X	X	-"-
DHCP server UDP port		X	-"-
DHCP Option 82			Section 24.1.2
Enable/Disable DHCP Option 82	X	X	-"-
Default Policy	X	X	-"-
Default Circuit-ID type	X	X	-"-
Remote-ID	X	X	-"-
DHCP Proxy Mode			Section 24.1.3
Force DHCP Option 54		X	-"-
<u>Per-Port DHCP Relay settings</u>			
Enable/Disable DHCP Relay	X	X	Section 24.1.4
DHCP Option 82			
Policy	X	X	Section 24.1.2
Circuit-ID type	X	X	-"-

24.1.1 Introduction to DHCP Relay Agents

One of the main reasons for using DHCP relay agents is to simplify DHCP management in larger infrastructures. Instead of deploying and managing a DHCP server on every LAN, a DHCP relay agent present on the LAN can forward DHCP messages between local DHCP clients, and a central DHCP server.

[Fig. 24.1](#) can be used to illustrate the use of DHCP relays and a central DHCP server.

- *(V)LAN interfaces:* The DHCP relay agents (here RA1-RA3) serve DHCP clients (here PC1-PC6) on the local LANs. A DHCP relay can serve a *single* LAN (Relay Agent 1 & 3) or *multiple* LANs (Relay Agent 2). In WeOS the LANs to serve is selected by configuring which (VLAN) network interfaces the relay agent should *listen* on.
- *DHCP Servers:* The relay agent must also know where to forward the DHCP

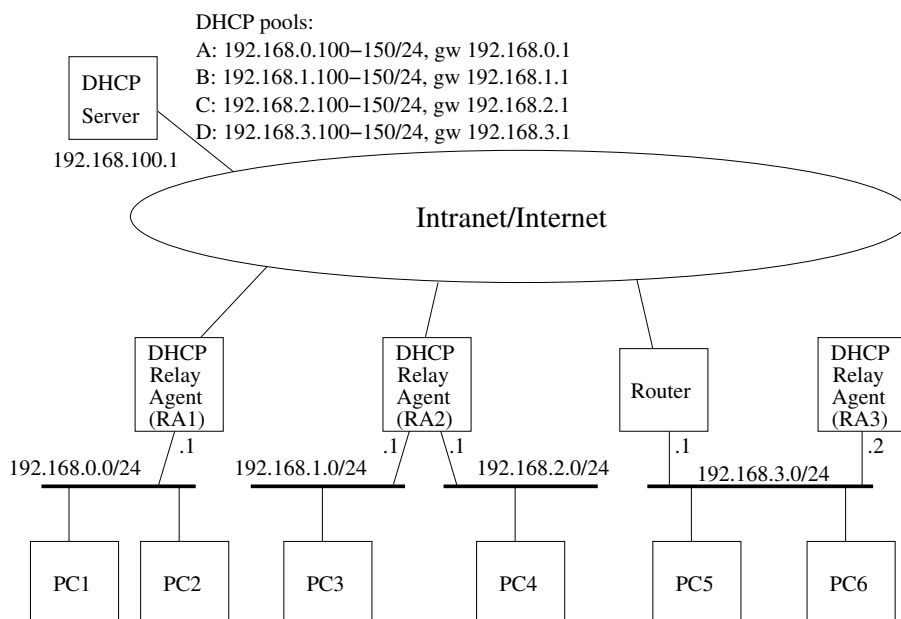

Figure 24.1: Sample topology where DHCP relay agents serve local DHCP clients, and forwards DHCP requests to/from a central DHCP server.

requests from the local PCs, i.e., the relay agent must be configured with IP address of the DHCP server (here *192.168.100.1*). As of WeOS v4.33.0, the relay agent can be configured with up to two DHCP servers. When configuring two DHCP servers, the DHCP relay will forward the DHCP requests to both servers, thereby providing redundancy.

DHCP servers listen to UDP port 67 by default. It is possible to configure the WeOS relay agent to forward packets to a different port on the server, see also [sections 24.1.5](#) and [23.1.3](#).

- *Address pools:* The DHCP server will in turn be configured with appropriate address pools (here denoted A-D), from which it can hand out addresses to the local PCs.

When a DHCP relay agent receives a DHCP request from a PC, it will add its local IP address into the *giaddr* field of the DHCP message when forwarding it to the server (e.g., RA1 will set *giaddr* to 192.168.0.1) when forwarding requests from PC1 to the DHCP server). Based on the *giaddr*, the DHCP server can distinguish which pool to hand out address from (here "A").

The DHCP server should also be configured with other relevant settings, e.g.,

default gateway, lease times, etc. (see [chapter 23](#)).

- *Running relay agents on routers or switches:* Relay agents can be run as dedicated servers (RA3), but are typically located inside the local routers (RA1 and RA2). By running the relay agents inside the routers, deployment and management costs are reduced, since no additional equipment is needed.

Although not shown in [fig. 24.1](#), it is also possible to run relay agents on (layer-2) switches. This is useful when you wish to assign IP addresses based on the physical port the PC connects to (see [section 24.1.2](#) for information on DHCP Option 82). In such use cases, you may also wish to run several relay agents within the same LAN – [section 24.1.4](#) provides more information on running relay agents in switched networks.

As of WeOS v4.33.0, it is only possible to run a single relay agent *instance* per WeOS unit. This is no major limitation, but implies, e.g., that a relay agent serving multiple LANs (RA2 in [fig. 24.1](#)) cannot be configured to forward the DHCP requests from different LANs to different sets of DHCP servers. A relay instance can serve up to MAX_DHCP_RELAY_IFACES (16) number of network interfaces.

24.1.2 DHCP Option 82

The *relay agent information option* (DHCP option 82, see RFC3046[38]) enables a relay agent to pass information to the DHCP server regarding which port the DHCP request came in on. Thus, an *option 82 aware* DHCP server would be able to assign IP settings (IP address, etc.) to a PC based on the port the PC connects to.

The DHCP option 82 contains two sub-options, *Circuit ID* and *Remote ID*:

- *Circuit ID:* The *circuit ID* identifies the port on the relay agent, where the DHCP request was received. Since the circuit ID can only be considered unique within the reporting relay agent, the DHCP server generally needs to consider both the *circuit ID* and an identifier of the specific relay agent (e.g., *giaddr* or *option-82 remote ID*, see below) when processing the DHCP request.

In WeOS the circuit ID can be set according to the following methods:

- *Disabled:* When circuit ID is *disabled*, no circuit ID sub-option is passed as part of the Relay Agent Information option (DHCP option 82).
- *Port Name:* Selecting the *port name* method implies that the circuit ID

will be represented as *Type* appended by the *port identifier*, e.g., Eth1 and DSL1 on a single slot product, or Eth1/1 and DSL1/1 on a multi-slot product (see [section 10.1.1](#) for more information on WeOS port naming conventions).

- *Port Description*: By selecting the *port description* method, the circuit ID will be represented by the *port description* setting of the associated port. However, as of WeOS v4.33.0 the port description ([chapter 10](#)) cannot yet be configured. Until configuration of port description is supported, the circuit ID will fall-back to using the *port name*, see above.
- *Manual*: You can configure the Circuit-ID manually per port. The Circuit ID will be sent as a byte sequence (max 9 bytes), and you can choose to enter your manual circuit ID setting either as an ASCII string (max 9 characters) or as hexadecimal number (max 18 hex characters).
- *Remote ID*: According to RFC3046[38], the purpose of the remote ID is to enable the DHCP relay agent to supply a trusted unique identifier of the DHCP client. In practice, it is commonly used as an identifier of the relay agent itself – the option 82 aware DHCP server can then base the IP address assignment on the combination of *circuit ID* and *remote ID*. In WeOS the remote ID can be set according to the following methods:
 - *Disabled*: When remote ID is *disabled*, no remote ID sub-option is passed as part of the Relay Agent Information option (DHCP option 82).
 - *MAC*: By selecting the *MAC* method, the unit's *base MAC address* (6 bytes, hexadecimal) will be used as remote ID. See [sections 4.4.2](#) (Web) and [7.3.2](#) (CLI) for information on how to read the unit's base MAC address.
 - *IP*: By selecting the *IP* method, the relay agent will use the IP address of the interface where the DHCP request came in as remote ID (i.e., the *giaddr*). E.g., if RA2 in [fig. 24.1](#) receives a DHCP request from PC4, it would use *192.168.2.1* as remote ID.
 - *System Name*: By selecting the *System Name* method, the unit's configured *hostname/system name* will be used as remote ID. See [sections 8.2](#) (Web) and [8.3.2](#) (CLI) for information on how to configure the unit's hostname/system name.
 - *Manual*: It is also possible to set a manual value for the Remote ID, either as a hexadecimal or string value.

When configuring a DHCP relay agent in WeOS, use of the relay agent information

option is by default disabled. When enabling DHCP option 82, the relay agent will add its relay information option to incoming DHCP requests, *unless* the request already contains a relay agent information option (added by some "downstream" relay agent)¹.

Below the possible policy settings are listed how the relay agent should handle incoming DHCP requests already containing a relay agent information option. The policy can both be specified globally (i.e., per relay agent), as well as on per port basis.

- *Discard*: Drop requests already containing a relay agent information option.
- *Forward*: If the request already contains a relay agent information option, keep that entry when forwarding the request towards your DHCP server(s).
- *Replace*: If the request already contains a relay agent information option, replace that with your own DHCP option 82 field when forwarding the request towards your DHCP server(s).
- *Append*: If the request already contains a relay agent information option, append your own relay agent information option field when forwarding the request towards your DHCP server(s).
- *Require*: Discard requests lacking a relay agent information option. If the request already contains a relay agent information option, keep that entry when forwarding the request towards your DHCP server(s). This option may be useful in topologies including a mix of relay agents supporting and not supporting *DHCP snooping* (see [sections 24.1.4](#), and [23.1.5.2](#)).

When handling DHCP requests already containing a relay agent information option, the following mechanisms apply to all policies:

- *Dropping requests lacking a giaddr*: As of WeOS v4.33.0, incoming requests containing a relay agent information option, but lacking a *giaddr*, will be discarded.
- *Keeping existing giaddr*: When forward a request which already contains a relay agent information option, the *giaddr* field will be unchanged.

As of WeOS v4.33.0 no validation is performed by the relay agent on relay agent information option field(s) included in DHCP messages returned from the DHCP Server. The relay agent information is always removed² before passing it back to

¹The exception is when policy "Require" is configured - then the packet will be discarded if it does not contain a relay agent information option.

²If more than one relay information option is included, the last option is removed.

the DHCP client (PC), or to a relay agent closer to the PC. This behaviour *may* give problems at downstream relay agents when using the *Forward*, *Append*, *Replace*, and *Require* policies. WeOS handling of packets on the return path from the DHCP server may be modified in upcoming WeOS releases.

24.1.3 DHCP Proxy Mode

According to the RFC2131[7] a DHCP relay agent would only be involved in the initial DHCP message, while subsequent DHCP lease renew messages would be sent directly between client and server, as shown in fig. 24.2.

For many use-cases however, this behaviour is not desirable. In particular with Option 82 (see section 24.1.2) all DHCP messages from the client to the server need to have this extra piece of information appended so that the server can properly identify the client. This is called DHCP Proxy Mode, or DHCP Server Identifier Override, defined in RFC5107[26].

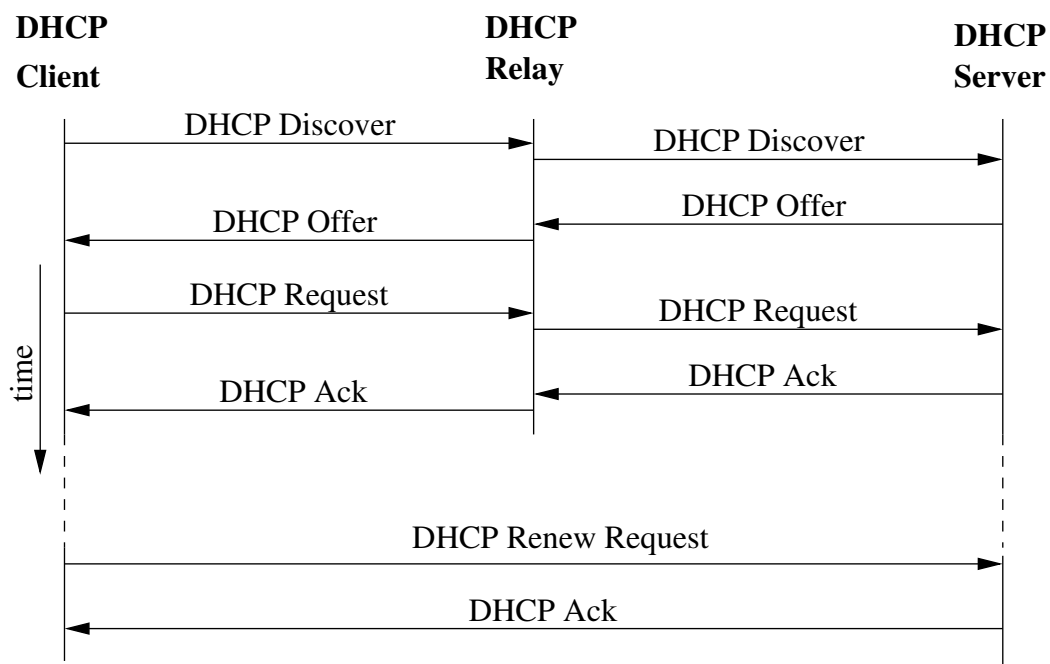

Figure 24.2: Typically only the initial DHCP exchange is done via the relay agent, while *lease renew messages* are sent directly (unicast) between client and server.

Most modern DHCP servers support RFC5107[26], which is a sub-option to Option 82. But some older DHCP servers do not and for this particular case the WeOS

relay agent can be configured to forcibly override Option 54, the Server Identity field. In effect, making sure that the client will send all DHCP messages via the relay agent, see [fig. 24.3](#).

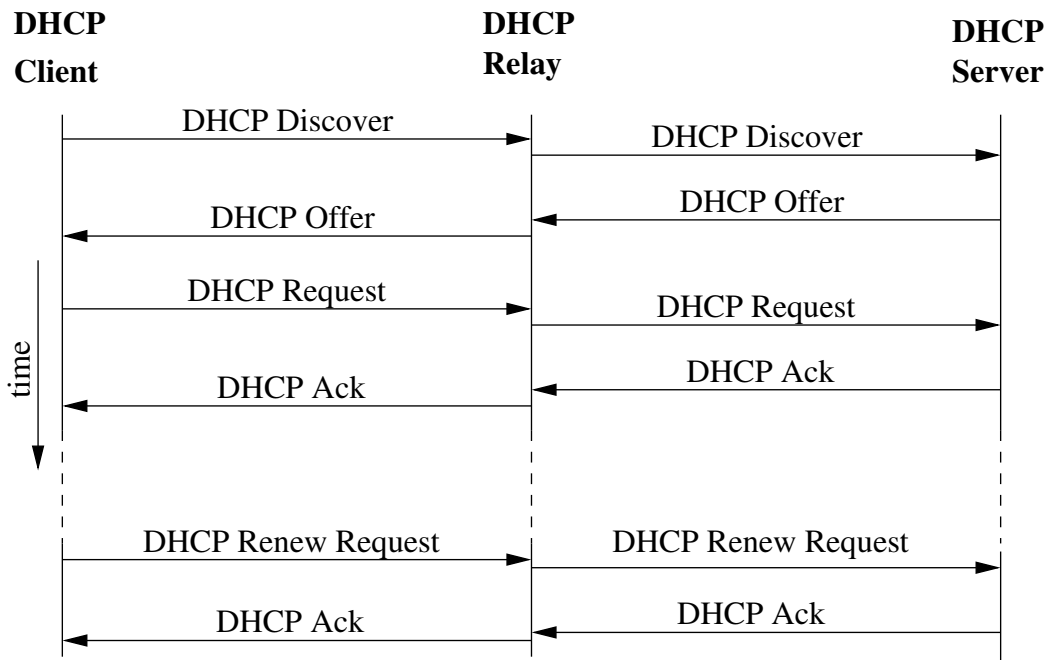

Figure 24.3: DHCP Proxy Mode, all messages goes via the relay agent.

Hence, there are two levels of DHCP Proxy Mode support in WeOS.

- *Hint to server:* The WeOS relay agent adds sub-option 11 to option 82 in all DHCP messages forwarded to the server, to *hint* the server to fill in the IP address of the relay agent in the DHCP server identity field in the server responses. If the server supports RFC5107[26], the relay agent will act as a server proxy towards the client ([fig. 24.3](#)).

Note
| The WeOS DHCP server ([chapter 23](#)) supports RFC5107[26].

- *Force identity override:* The WeOS relay agent can force server identity override by updating the packets sent towards the DHCP client. This feature can be useful in situations where the DHCP server does not support RFC5107[26]. Forcing DHCP server identity override is disabled by default.

24.1.4 Relay Agents in Switched Networks

The DHCP protocol uses layer-2 broadcast (Destination MAC: ff:ff:ff:ff:ff:ff) for some of its protocol messages. Therefore, a (broadcast) DHCP packet coming in to a switch, will typically be flooded on all ports of the same LAN. This is illustrated in fig. 24.4a):

- A broadcast DHCP message comes in on port "A" of the switch (step "1a").
- The message is broadcasted *unmodified* on all other ports within the LAN (here ports "B"- "F"), see step "1b".
- In this case, the switch is also running a DHCP relay service on the LAN. The relay agent will process the incoming DHCP packet, and forwards it to the configured DHCP server, which here happens to reside in the direction of port "E" (step "2"). The packet in step "2" is modified as compared to the initial broadcast packet: It is sent as unicast to the DHCP server, and it contains the relay agents IP address as *giaddr*. If the relay agent has DHCP option 82 enabled, such information is also added.

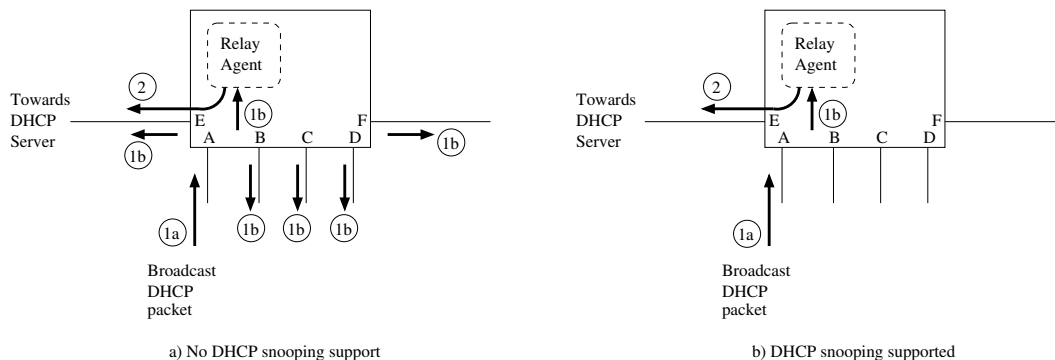

Figure 24.4: Propagation of DHCP broadcast packets in switches running DHCP relay agents. All ports are on the same (V)LAN. The switch in figure a) does not support DHCP snooping, while the switch in figure b) supports DHCP snooping.

As seen in fig. 24.4a), using (layer-2) switches as DHCP Relay Agents can result in multiple versions of a DHCP message to be sent towards the DHCP server: the original request being switched/broadcasted, and the one being relayed by the relay agent process. This will not cause any problems if the DHCP server is located on some remote network; then only the relayed packet will reach the server. However, if the DHCP server is located within the same LAN, adequate support is needed at the DHCP server to know which request to serve and which to ignore (see section 23.1.5.2 in the DHCP server chapter for more information).

The number of "copies/versions" of a DHCP request can increase further if a LAN consists of several switches with DHCP relay agents (discussed later on, see [fig. 24.5](#)).

To mitigate multiplication of broadcast DHCP messages, some switches support *DHCP snooping* (see also [section 24.1.5](#) for an alternative approach). With DHCP snooping enabled on an Ethernet/DSL port, *all* DHCP packets will pass through the DHCP relay agent – this includes broadcast and unicast DHCP packets, both DHCP requests (to server) or DHCP responses (from server) coming in on that port. [Fig. 24.4b](#)) shows the result when a broadcast DHCP packet comes in on a port with DHCP snooping enabled.

When configuring a WeOS relay agent on a VLAN interface, all ports on that VLAN will have DHCP snooping enabled

- the exception is products lacking hardware support for DHCP snooping³. More fine-grained control to enable/disable DHCP snooping per port may be supported in later WeOS versions.

DHCP relay service can be disabled on a per port basis. If DHCP relaying is disabled on an Ethernet/DSL port, incoming DHCP packets will be switched as other layer-2 packets (no DHCP snooping), and the DHCP relay agent on the switch will ignore DHCP requests entering the switch on that port.

[Fig. 24.5](#) presents an example where multiple relays are located within the same VLAN – port 1-6 on all RA units are in the same VLAN, while port 7 on RA1 and RA2 are associated with another VLAN used and used as upstreams interface. The topology in [fig. 24.5](#) utilise several WeOS features to achieve a robust network: FRNT ([chapter 16](#)) is used to handle single link failures within the local network. VRRP ([chapter 32](#)) is used to handle router redundancy (RA1 and RA2). A second DHCP server to protect against DHCP server failure⁴.

The relay agents (RA1-RA5) server DHCP clients connecting to the local access ports (ports 1-4), and will relay each request (unicast) to the configured DHCP server(s). Below a sample DHCP relay configuration is shown, which would be suitable for all relay agents in [fig. 24.5](#).

³In WeOS products, DHCP Snooping is supported on all Ethernet/DSL ports, **except** for ports of switchcore(s): MV88E6185 and MV88E6046. Please see *Detailed System Overview* page in the Web ([section 4.4.2](#)) or use the "**show system-information**" in the CLI ([section 7.3.2](#)) to find information about what switchcore(s) is used in your product.

⁴As of WeOS v4.33.0, the WeOS DHCP server ([chapter 23](#)) does not provide dedicated DHCP server failover support, but you can achieve redundancy using "static" address assignment (no address pools) with the same configuration at both DHCP servers.

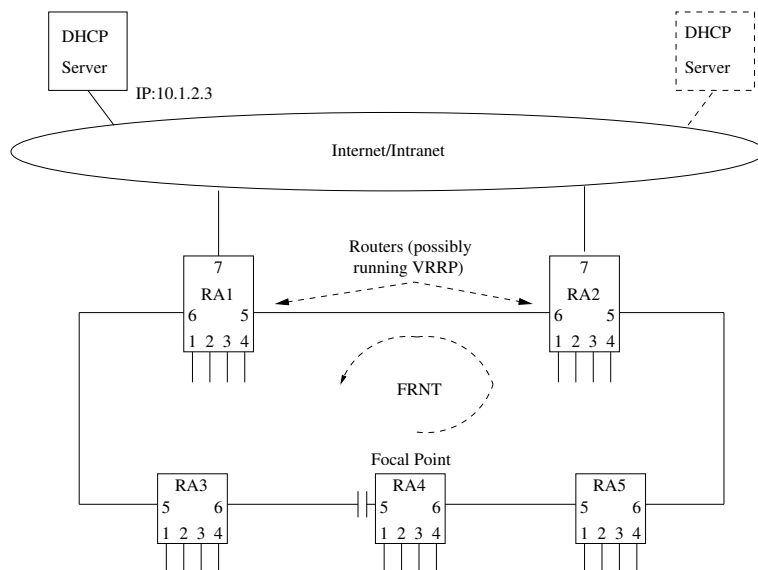

Figure 24.5: Example with multiple DHCP Relay Agents within the same VLAN (port 1-6 on all RAs are assumed to be on the same VLAN, e.g., VLAN 1).

Example

```
dhcp-relay
  iface vlan1
  server 10.1.2.3
  option82 discard
  port 5-6
    no enable
  end
end
```

- DHCP relay has been enabled on interface vlan1 (this assumes that ports 1-6 are all associated with VLAN 1).
- A single DHCP server has been configured (here 10.1.2.3). As of WeOS v4.33.0, up to two DHCP servers can be configured.
- Option 82 is enabled, with policy discard. Option 82 information will be added to all incoming requests. Packets which already include option 82 information will be discarded. Default settings for *circuit-id* (port name) and *remote-id* (base-MAC) will be used.
- DHCP requests coming in on port 5 or 6 will be ignored by the relay agent. No DHCP snooping will be done on those ports, thus a DHCP request being

relayed by RA4 to the DHCP server, will be forwarded through RA5 like any other packet.

24.1.5 Mitigating duplication of DHCP messages by using a different server port

An alternative to address the issue with multiple DHCP requests in switched topologies with non-snooping relay agents is to let the DHCP server listen on a non-standard UDP port (section 23.1.3). The DHCP relay agent can be configured to forward its packets to this server port (section 24.1.1), thus all *relayed* packets will reach the server. Packets coming directly from the client will be dropped by server, since they are sent to the regular DHCP server UDP port (67).

Example

-- DHCP Server configuration of non-standard listen port

```
example-server:/#> configure
example-server:/config/#>
example-server:/config/#> dhcp-server
example-server:/config/dhcp-server/#> server-port 6767
example-server:/config/dhcp-server/#> leave
Stopping DHCP/DNS Server ..... [ OK ]
Starting DHCP/DNS Server ..... [ OK ]
Configuration activated. Remember "copy run start" to save to flash (NVRAM).
example-server:/#>
```

-- DHCP Relay Agent configuration of non-standard server port

```
example-relay:/#> configure
example-relay:/config/#> dhcp-relay
example-relay:/config/dhcp-relay/#> server-port 6767
example-relay:/config/dhcp-relay/#> leave
Stopping DHCP/DNS Server ..... [ OK ]
Starting DHCP/DNS Server ..... [ OK ]
Configuration activated. Remember "copy run start" to save to flash (NVRAM).
Starting DHCP Relay Agent ..... [ OK ]
example-relay:/#>
```

24.2 Configuring DHCP Relay Agent via the Web

The Web interface provides management of the DHCP Relay Agent.

24.2.1 DHCP Relay Agent settings

Menu path: Configuration ⇒ Network (IP) ⇒ DHCP-Relay

Enabled

Listening Interfaces

Name	
vlan2	

vlan1

DHCP Servers

Address	
192.168.66.40	

Global Option 82 Settings

Policy	<input type="text" value="Forward"/>
Circuit ID	<input type="text" value="Port Name"/>
Remote ID	<input type="text" value="MAC"/>

Figure 24.6: DHCP Relay Agent settings

Listening Interfaces	The Listening Interface specifies on which interface(s) the relay agent will listen for client requests. DHCP server responses may come in through any interface.
DHCP Servers	The DHCP Servers settings determine to which DHCP servers each DHCP client request will be sent. At most two servers may be configured.
Global Option 82 Settings	<p>The Global Option 82 Settings determine how the DHCP Relay Agent Information option, also known as Option 82, will be handled. The policy specify how to treat incoming client requests that already contain an Agent Information option.</p> <ul style="list-style-type: none"> • Disable: Do not add option 82 field. Any existing option 82 will be retained. • Forward: Adds a new option 82 or forwards any existing option 82. • Append: Appends a new option 82 in addition to any existing option 82. • Discard: Drops the whole packet if it contains an option 82. • Replace: Removes any existing option 82 and adds a new option 82. • Require: Requires that the incoming packet contains an option 82 otherwise it will be dropped.

The **Circuit ID** setting determines how the Circuit-Id field of option 82 will be filled. It can be one of **None**, **Port Name** and **Port Description**. **None** will leave this field with zero length, **Port Name** will fill this field with the port type and name of the port as seen on front foil, stripped of any whitespace. E.g. Eth6 for Ethernet port 6. Lastly **Port Description** will use the description given to the port in the port settings.

In a similar fashion the **Remote ID** tells how the Remote-id field of option 82 will be set. **None** set its length to zero, **IP** sets it to the IP address of the inbound interface. **MAC** uses the base MAC address of the unit. **System Name** uses the hostname of the system. It is also possible to set a **Manual** value for the Remote-ID, either as a hexadecimal or string value.

24.2.2 DHCP Relay Agent Per-Port Settings

Menu path: Configuration ⇒ Network (IP) ⇒ DHCP-Relay Agent ⇒ Port Specific Settings Show

Port Specific Settings

Hide ▲

Port	Relaying Enabled	Option 82		
		Policy	Circuit ID Type	
1	<input checked="" type="checkbox"/>	Global	Manual (hex)	ffee
2	<input checked="" type="checkbox"/>	Global	Port Name	Eth2
3	<input type="checkbox"/>	Global	Global	Eth3
4	<input checked="" type="checkbox"/>	Global	Global	Eth4
5	<input checked="" type="checkbox"/>	Global	Port Name	Eth5
6	<input checked="" type="checkbox"/>	Require	Global	Eth6

Apply Cancel

Figure 24.7: DHCP-Relay Agent Per-Port Settings page

Enabled	The Enabled checkbox tells whether to enable the relay agent on this port, i.e. whether to listen for client requests on this port or not. If enabled, you can override the global settings.
Option 82 Policy	See section 24.2.1 for an explanation of the different policy options. In the port specific section, the Policy setting has an additional option Global , indicates that the global policy setting (see fig. 24.6) will be used for this port.
Option 82 Circuit ID	See section 24.2.1 for an explanation of the different circuit ID types. In the port specific section, the Circuit ID setting has additional options for the Circuit ID type. <ul style="list-style-type: none"> • Global: Indicates that the global circuit ID setting (see fig. 24.6) will be used for this port. • Manual (hex) and Manual (string): A user specified <i>hex</i> or <i>string</i> value will be used as circuit ID. Value is entered in the Manual Circuit ID field.

24.3 Configuring DHCP Relay Agent via the CLI

Command	Default	Section
<u>Configure DHCP Relay Agent</u>		
[no] dhcp-relay		Section 24.3.1
[no] enable	Enabled	Section 24.3.2
[no] iface <IFACE>	Disabled	Section 24.3.3
[no] server <IPADDR>	Disabled	Section 24.3.4
[no] server-port <PORT>	Disabled	Section 24.3.5
[no] force-server-identity	Disabled	Section 24.3.6
[no] option82 <forward discard append replace require>	Disabled	Section 24.3.7
[no] circuitid-type <portname portdescription>	"portname"	Section 24.3.8
[no] remoteid-type <mac ip system-name manual <hex string> <VALUE>>	"mac"	Section 24.3.9
port <PORTLIST all>		Section 24.3.10
[no] enable	Enabled	Section 24.3.11
[no] option82 <auto forward discard append replace require>	"auto"	Section 24.3.12
[no] circuitid-type <auto portname portdescription manual <hex string> <ID>>	"auto"	Section 24.3.13
<u>View DHCP Relay Agent Settings</u>		
show dhcp-relay		Section 24.3.14
dhcp-relay show port [PORTLIST]	"all"	Section 24.3.15

24.3.1 Manage DHCP Relay Agent

Syntax [no] dhcp-relay

Context [Global Configuration](#) context

Usage Create, modify or remove the DHCP Relay Agent.
Enter DHCP Relay Configuration context.

Use **"no dhcp-relay"** to remove an existing DHCP relay configuration.

Default values Not applicable.

24.3.2 Enable DHCP Relay Agent

Syntax [no] enable

Context [DHCP Relay Configuration](#) context

Usage Enable the DHCP Relay Agent.

Default values Enabled.

24.3.3 Listening Interfaces

Syntax [no] iface <IFACE>

Context [DHCP Relay Configuration](#) context

Usage Specify the interfaces that the relay agent will listen to.

 **Note**

If the interface includes an aggregate of physical ports that is a part of the aggregate will be represented with the aggregate port.

Default values Not applicable.

24.3.4 DHCP Servers (IP addresses)

Syntax [no] server <ADDRESS>

Context [DHCP Relay Configuration](#) context

Usage Specify the DHCP server that the relay agent will forward requests to.

Default values Not applicable.

24.3.5 DHCP Server UDP port

Syntax [no] server-port <UDPPORT>

Context [DHCP Relay Configuration](#) context

Usage Specify the DHCP server UDP port that the relay agent will forward requests to. See also [section 23.3.8](#) for the corresponding DHCP relay agent setting.

Use **"no server-port"** to reset to default value (port 67).

Use **"show server-port"** to show current server-port settings.

Default values 67

24.3.6 Force DHCP Server Identity Override

Syntax [no] force-server-identity

Context [DHCP Relay Configuration](#) context

Usage By enabling the *force DHCP server override* setting, the DHCP relay agent can work-around older DHCP servers that do not support RFC5107[26] (a hint/extension to Option 82) by overriding Option 54 in the server response to the client with the relay agents IP address.

It is recommended to leave this setting disabled and instead either use the WeOS DHCP server, or upgrade to another RFC compliant DHCP server.

Use **"force-server-identity"** to enable *force DHCP server override* and use **"no force-server-identity"** to disable it.

Use **"show force-server-identity"** to show the current setting.

Default values Disabled

24.3.7 Option 82

Syntax [no] option82 <forward|discard|append|replace|require>

Context [DHCP Relay Configuration](#) context

Usage Enable or disable the addition of option 82, a.k.a. relay agent information, to DHCP requests. The policy for how to handle any existing option 82 can optionally be specified as follows.

Forward

Adds a new option 82 or forwards any existing option 82.

Append

Appends a new option 82 in addition to any existing option 82.

Discard

Drops the whole packet if it contains an option 82.

Replace

Removes any existing option 82 and adds a new option 82.

Require

Requires that the incoming packet contains an option 82 otherwise it will be dropped.

Default values Option 82 is disabled by default, if enabled and policy is omitted it defaults to **forward**.

24.3.8 Circuit ID Type

Syntax [no] circuitid-type <portname | portdescription>

Context [DHCP Relay Configuration](#) context

Usage Specify how the circuit id in option 82 will be set. **portname** will use the name of the port as it is printed on the front foil plus the port type. For Ethernet ports it will be Eth, so e.g. requests coming in on port 6 will have the Circuit ID set to "Eth6". **portdescription** is currently the same as **portname** but will use the port description set in the port configuration, as soon as that feature is released.

Default values portname.

24.3.9 Remote ID Type

Syntax [no] remoteid-type <mac | ip | system-name | manual <hex|string> <VALUE>>

Context [DHCP Relay Configuration](#) context

Usage Specify how the remote id in option 82 will be set.

- Use command "**remoteid-type mac**" to use the unit's base MAC address as remote-id.
- Use command "**remoteid-type ip**" to use the unit's IP address (IP address of the interface where the DHCP client request comes in, see [section 24.3.3](#)).
- Use command "**remoteid-type system-name**" to use the unit's host-name as remote-id.

- Use command **"remoteid-type manual string <VALUE>"** and **"remoteid-type manual hex <VALUE>"** set remoteid-type manually as a string or hex value.
- Use command **"no remoteid-type"** to skip sending a remote-id.
- Use command **"show remoteid-type"** to show the current remoteid type setting.

Default values mac

24.3.10 Manage DHCP Relay Agent Per-Port Settings

Syntax port <PORT|PORTS>

Context [DHCP Relay Configuration](#) context

Usage Enter DHCP Relay Port Configuration context to modify DHCP Relay Agent configuration for one or several ports.

Default values Not applicable.

24.3.11 Enable/disable DHCP Relay Agent per port

Syntax [no] enable

Context [DHCP Relay Port Configuration](#) context

Usage Enable or disable the DHCP Relay Agent on a port.

Default values Enabled.

24.3.12 Option 82 policy per port

Syntax [no] option82 <auto|forward|discard|append|replace|require>

Context [DHCP Relay Port Configuration](#) context

Usage Enable or disable the addition of option 82 on one ore more ports. The **auto** policy uses the same a policy as specified in the *DHCP Relay* context.

Default values auto.

24.3.13 Option 82 Circuit ID per port

Syntax [no] circuitid-type <auto|portname|portdescription>

Context DHCP Relay Port Configuration context

Usage Specify how the circuit id in option 82 will be set for this port. In addition to the keywords defined in [section 24.3.8](#) **auto** can be used, meaning the configured circuit ID type in *DHCP relay* context.

Default values auto.

24.3.14 Show DHCP Relay Agent Settings

Syntax show dhcp-relay Also available as **"show"** command within the [DHCP Relay Configuration](#) context context.

Context Global Configuration context

Usage Show DHCP relay agent settings.

Default values

24.3.15 Show DHCP Relay Agent Per-port Settings

Syntax show port [PORTLIST] Also available as **"show"** command within the [DHCP Relay Port Configuration](#) context.

Context DHCP Relay Configuration context

Usage Show DHCP relay agent per port settings. Furthermore, not only the circuit ID *type* settings are listed, but also the resulting *circuit ID*.

Default values If no PORTLIST is given, settings are listed for all ports associated with the given (VLAN) interfaces (see also [section 24.3.3](#)).

 **Example**

```
example:/config/dhcp-relay/#> show port
Port      Enabled Policy Circuit-ID type      (Circuit ID)
-----
Eth 1     NO      auto   auto                (Eth1)
Eth 2     NO      auto   auto                (Eth2)
Eth 3     YES     auto   auto                (Eth3)
Eth 4     YES     auto   auto                (Eth4)
Eth 5     YES     auto   auto                (Eth5)
Eth 6     YES     auto   auto                (Eth6)
example:/config/dhcp-relay/#>
```

24.4 Feature Parameters

MAX_DHCP_RELAY_IFACES 16

Chapter 25

Alarm handling, Front panel LEDs and Digital I/O

This chapter describes WeOS features for alarm and event handling ([sections 25.1-25.3](#)). The chapter also covers general information on functionality related to *Digital I/O* and *front panel LEDs* ([sections 25.4](#) and [25.5](#)).

25.1 Alarm handling features

The table below summarises the WeOS alarm handling features.

Feature	Web	CLI	General Description
Configure alarm triggers	X	X	Sections 25.1.1-25.1.3
Configure alarm actions	X	X	Sections 25.1.1 and 25.1.4
Configure alarm targets	X	X	Sections 25.1.1 and 25.1.5
View alarm status ¹	X	X	Section 25.1.5

25.1.1 Introduction to the WeOS alarm handling support

The WeOS alarm handling support makes use of the following terminology:

- *Alarm sources*: An *alarm source* is an object being monitored by an *alarm trigger*, e.g., the link status (up/down) of an Ethernet port, the input byte

¹In addition to monitoring alarm status via Web and CLI, there are other ways in which an operator can get notified when an alarm is triggered.

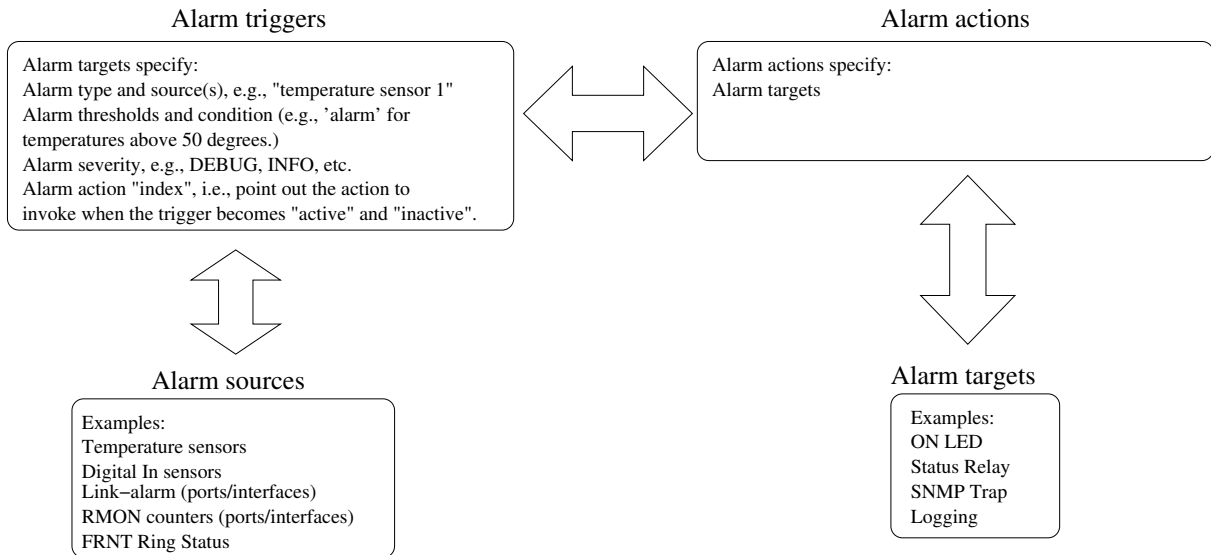

Figure 25.1: Overview of WeOS alarm entities: Alarm triggers monitor the state of alarm source, and define conditions and thresholds when to invoke an associated alarm action. The invoked alarm action specifies what alarm target(s) to use to notify the operator.

counter of a network interface, or the temperature value of a temperature sensor. Alarm sources are described further in [section 25.1.2](#).

- *Alarm trigger*: An *alarm trigger* monitors alarm sources, and defines the conditions when alarm events occur, i.e., when the trigger becomes *active* (alarm situation) or *inactive* (normal situation).

In addition, the alarm trigger specifies the *alarm action* to be invoked once an alarm event occurs. Alarm triggers are described further in [section 25.1.3](#).

- *Alarm actions and alarm targets*: When an alarm event occurs, the operator can be notified via SNMP traps, logging, status relay (digital-out), and front panel status LED. These notification mechanisms are referred to as *alarm targets*.

Instead of mapping triggers directly to targets, a trigger is mapped to an *alarm action (profile)*. The alarm action defines what specific targets to use when an alarm event occurs. For example, a link alarm trigger for ports 1-3 can be mapped to a specific alarm action, which in turn specifies *logging* and *SNMP traps* as targets. Alarm actions and targets are described further

in [sections 25.1.4](#) and [25.1.5](#) respectively.

25.1.2 Alarm sources

As of WeOS v4.33.0 the following alarm sources are supported:

- *Power failure*: If the unit is equipped with redundant power feed (or redundant power supply), an alarm can be triggered if one of the feeds lack input power.

Note: if all power is lacking on all feeds, the unit is powerless and cannot trigger alarms via SNMP traps or remote logging. To detect such a situation remotely, the operator could *poll* the unit (e.g., by *pinging* the unit on a regular interval). The drawback is that it is difficult to distinguish problems in the intermediate network from problems in the monitored device.

An alternative is to use out-of-band signalling, e.g., via GPRS equipment connected to the *status relay* (digital-out) to get an alarm notification instantly if a device goes down.

- *Link alarm*: It is possible to configure link alarm triggers to react when a link goes down (and up).
- *Digital-In*: Alarms can be triggered depending on the presence of input voltage/current on the *Digital-In* pins of the Digital I/O connector.
- *Temperature sensor alarms*: Temperature alarm triggers can be configured to react when the temperature rises above (or falls below) some defined threshold.
- *FRNT status*: The FRNT ring status trigger will react when an FRNT ring is broken or healed (intact)¹.
- *RiCo/Dual-Homing uplink status*: The RiCo uplink status trigger will react if a RiCo (or Dual-Homing) uplink comes up or goes down. Both physical link status and Uplink Echo response are used to determine the uplink status.
- *MRP status*: The MRP ring status trigger will react when an MRP ring is broken or healed (intact).
- *Hardware failure*: Hardware alarms triggers notifies that the unit has detected a hardware failure (typically if an unsupported SFP is inserted).

¹Only an FRNT focal point can determine the ring status with certainty.

- *SHDSL/xDSL SNR Margin*: On devices with SHDSL/xDSL ports, alarms can be triggered when the SNR margin falls below some configured threshold.
- *Link Fault Forward (LFF)*: On devices with SHDSL ports, alarms can be triggered when the remote SHDSL switch indicates it has link down on its Ethernet port. That is, this feature can be used in topologies where an Ethernet is extended over an SHDSL link, and where the remote SHDSL switch (e.g., a DDW-120) is able to signal that the Ethernet link is down on its side.
- *Network Connectivity (Ping)*: It is possible to have a trigger to monitor network connectivity by using the *ping* command to a specific host. The remote node is considered unreachable if a configurable number of pings are lost, and considered reachable if the same number of pings are successfully received.

**Note**

Make sure the remote host responds to ICMP ping. A typical behaviour of many hosts is that ICMP ping is blocked in the host's firewall.

- *PoE Power Usage*: On units supporting Power Over Ethernet (PoE), alarms can be triggered when the total power usage raises above (or falls below) some configured threshold.
- *Microlok Session Status* On units running a Microlok Gateway ([chapter 43](#)), an alarm can be triggered if any of the established sessions go down.
- *Address Conflict*: An alarm can be triggered to monitor a designated VLAN network interface for address conflicts.

25.1.3 Alarm triggers

An alarm trigger defines the rules for when alarm events should be generated for a monitored alarm source. Alarm triggers also define which *alarm action* to invoke when an alarm event occurs.

Currently supported alarm trigger types:

- Power failure
- Link alarm
- Digital-In
- Temperature

- FRNT ring status
- RiCo uplink status (applies both to RiCo and Dual-Homing uplinks)
- MRP ring status
- Hardware failure (The *hardware failure* alarm trigger is *implicit*, and cannot be removed or modified.)
- SNR margin (SHDSL and xDSL ports)
- LFF (SHDSL ports)
- Timer
- Ping
- PoE power usage
- Microlok Session Status
- Address Conflict

As the WeOS alarm handling support is designed to include triggers for additional alarm sources, the following description is of more general nature, thus contains more options than needed for the trigger types currently supported.

**Note**

As of WeOS v4.33.0 there is no support for making an alarm trigger *persistent*. When an alarm condition is no longer fulfilled, the trigger status will become *inactive*. As alarms are not persistent, it is not possible for an operator to clear (i.e., acknowledge) an alarm.

25.1.3.1 Specifying what alarm source(s) a trigger should monitor

Different types of alarm triggers operate on different types of alarm sources:

- Power failure: A power failure trigger can monitor one or more power feed sensors. Most WeOS products have two power feeds (single power supply), with a sensor for each power feed. Typically a single power failure trigger is used to monitor both power feed sensors.
- Digital-In: A digital-in trigger can monitor one or more digital-in sensors. WeOS products typically have a single digital-in sensor.

- Link alarm: Link alarm triggers monitor the operational status (up/down) of Ethernet or DSL ports. Thus when configuring a link alarm trigger the port (or ports) to monitor should be specified.

 **Note**

It is possible to define multiple link alarm triggers, where each trigger can monitor different ports and be mapped to different alarm actions.

In the future, link alarm triggers can be extended to monitor the operational status of *network interfaces* and *VLANs* in addition to physical ports (Ethernet, SHDSL, etc.).

- RMON statistics (not yet supported): The alarm source for an RMON trigger is specified by two parameters: (1) the name of the statistics counter (e.g., *etherStatsPkts*), and (2) the port (or list of ports) for which this counter should be monitored.

 **Note**

In WeOS the term RMON is used to refer to data traffic statistics in general; not only to the Ethernet statistics defined in the RMON MIB. Thus, if a counter from the IF-MIB (such as *ifHCInUcastPkts*) is specified, the alarm source could refer to *network interfaces* or *VLANs* as well as a physical ports (Ethernet, SHDSL, etc.).

- Temperature: Temperature triggers can apply to one or more temperature sensors.
- FRNT: FRNT triggers can apply to one or more FRNT rings.
- MRP: MRP triggers can apply to one or more MRP rings (as of WeOS v4.33.0 only a single MRP ring is supported).
- RiCo/Dual-Homing: RiCo uplink triggers can apply to one or more RiCo (or Dual-Homing) uplink ports.
- Timer: Timer triggers are configured to go off at given *time interval*. As of WeOS v4.33.0, only daily timers are supported, e.g., "**timeout daily 02:30**", and only apply to "**log**" and "**reboot**" action targets.
- SNR Margin: An SNR Margin trigger applies to one or more SHDSL/xDSL ports.

- LFF (Link Fault Forward): An LFF trigger applies to one or more SHDSL ports.
- Ping: A connectivity checker, sends an ICMP ping in a configurable interval.
- PoE Power Usage: The WeOS PoE enabled units have a *single* PoE power module, and its current usage level is used as trigger source (i.e., no need to select a trigger source).
- Address Conflict Interface: An Address Conflict trigger applies to a VLAN network interface. The trigger monitors if any IPv4 address or MAC address used by the WeOS unit is also used by another device on the VLAN. Only one VLAN network interface can be configured per Address Conflict trigger.

Typically there would be no more than one trigger monitoring the status of a specific alarm source. However, in some cases it would make sense to have multiple triggers monitoring a single alarm source. For example, one could define two temperature triggers for a single temperature sensor, where one trigger reacts if the temperature rises above a *warning threshold* (say 60°C), and the other if the temperature gets *critically high* (say 75°C).

25.1.3.2 Alarm thresholds and trigger output

For the trigger to know when an alarm event has occurred, threshold values for the monitored alarm sources must be configured. Alarm sources which are 'binary' to their nature (link up/down, power up/down, digital-in high/low, etc.) have thresholds defined *implicitly*.

For sources which can take values in a wider range (temperature, SNR Margin, received packets within a given time interval, etc.) the alarm thresholds should be *configured*. Fig. 25.2a) illustrates use of alarm thresholds for a temperature trigger.

As can be seen in fig. 25.2a), two thresholds are used – a *rising* threshold and a *falling* threshold. Alarm events will be generated when reaching the rising threshold on the way up, and the falling threshold on the way down. However, once a rising alarm event has occurred, a new rising alarm event cannot be generated (for that alarm source) before the value has fallen down to the falling threshold (and vice versa). Thus, the use of separate rising and falling thresholds creates a *hysteresis* mechanism, which avoids generating multiple alarm events when a monitored value fluctuates around the alarm threshold.

Alarm targets such as the *status relay* (Digital-Out) and the *ON LED* provide a summary alarm function (see section 25.1.5.1), and these targets assume that

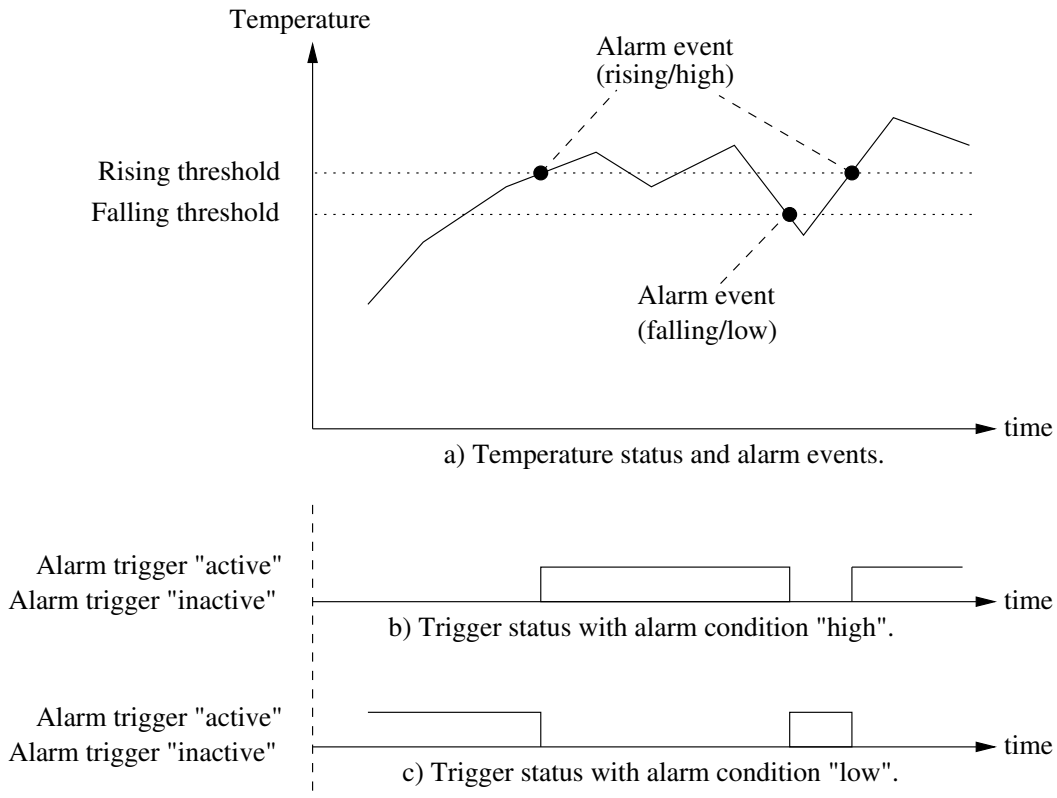

Figure 25.2: Example use of rising and falling thresholds for a temperature alarm trigger (a), and alarm condition setting to affect active and inactive trigger status (b and c).

every alarm trigger define the condition when the alarm is *active* ("alarm" situation) and *inactive* ("normal" situation). To define this the alarm *condition* configuration option is used. To warn the operator for high temperatures, the alarm condition should be set to "high", see [fig. 25.2b](#)). If we instead wish to warn the operator for low temperatures, the alarm condition should be set to "low", see [fig. 25.2c](#)). A corresponding example for a *Digital-In* trigger is shown in [fig. 25.3](#).

Additional details on threshold settings and properties:

- The rising threshold cannot be set lower than the falling threshold.
- It is possible to use the same value for the rising and falling thresholds.
- Rising alarm events occur if the current sample value is equal or above the rising threshold, and the previously sampled value was below the rising

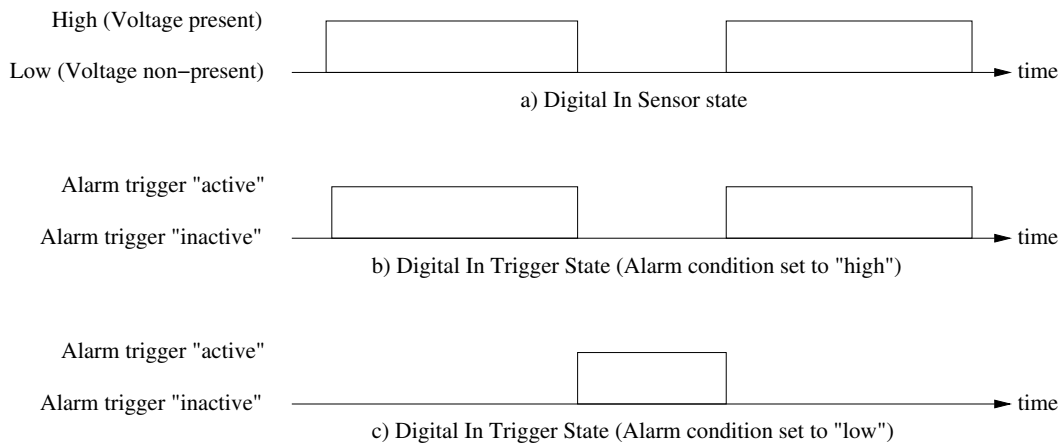

Figure 25.3: Alarm condition example: The alarm trigger for digital-in can be configured to become active when the signal is high (b) or when it is low (c).

threshold. A rising alarm event will also occur if the *first* sampled value is equal or above this threshold, and the *condition* variable is configured as *rising* (or any of its equivalents: *high* or *up*).

- Falling alarm events occur if the current sample value is equal or below the falling threshold, and the previously sampled value was above the falling threshold. A falling alarm event will also occur if the *first* sampled value is equal or below this threshold, and the *condition* variable is configured as *falling* (or any of its equivalents: *low* or *down*).

25.1.3.3 Sample types and interval

Two sample types are possible: *absolute* and *delta* sampling. With absolute sampling, the value is compared directly to the alarm thresholds. With delta sampling it is the difference between the current sample and the previous sample which is compared to the alarm thresholds.

Alarm sources of *counter* type, such as RMON data traffic statistics, are well suited for delta sampling. As the delta is computed over a given time interval (sample interval), the alarm thresholds should be configured with respect to the configured sample interval.

**Note**

As of WeOS v4.33.0 only absolute sampling is supported, and the sampling interval is not configurable for any trigger type.

25.1.3.4 Alarm severity

For each trigger it is possible to define the severity level of the associated alarm events. The levels defined by Unix Syslog are used:

- EMERG: System is unusable
- ALERT: Action must be taken immediately
- CRIT: Critical conditions
- ERR: Error conditions
- WARNING: Warning conditions
- NOTICE: Normal, but significant, condition
- INFO: Informational message
- DEBUG: Debug-level message

It is also possible to configure severity level "NONE". Alarm events with severity NONE will not cause SNMP traps to be sent or events to be logged, however, such events can still affect the status relay (digital-out) and ON LED targets.

**Note**

Severity levels can be configured independently for the events when an alarm trigger becomes "active" and "inactive". Default severity level are WARNING for "active" alarm events and NOTICE for "inactive" alarm events.

The severity level configured for a trigger affects how alarm events are filtered for SNMP trap and logging alarm targets ([section 25.1.5](#)). Alarm events of severity level INFO or higher are subject both to logging and SNMP trap targets. As described in [chapter 27](#) it is possible to conduct additional filtering for remote logging based on event severity.

25.1.3.5 Mapping triggers to actions

Triggers can be mapped to alarm actions (profiles) that are invoked when an alarm event occurs, for more information see [section 25.1.4](#). However, it is also possible to leave a trigger unmapped, e.g., when defining a *ping trigger* to adjust VRRP priority dynamically (see [section 32.1.1](#)).

25.1.4 Alarm actions - mapping triggers to targets

Instead of mapping triggers directly to alarm targets, each trigger is mapped to an alarm action (alarm action profile). The alarm action specifies which targets to use (SNMP traps, Logging, ON LED, and status relay) when an alarm event occurs.

It is possible to configure several actions (action profiles). Each trigger can be mapped to an individual action, but it is also possible for multiple triggers to share the same action. This can be particularly useful when managing several triggers of similar type, such as different types of RMON triggers.

By default a trigger is mapped to the *default alarm action* (index 1). The default alarm action cannot be removed.

25.1.5 Alarm presentation (alarm targets)

When an alarm situation occurs, such as an FRNT ring failure, WeOS enables the operator to be notified in numerous ways:

- *SNMP trap*: Alarms can be configured to generate SNMP traps². See [chapter 6](#) for general information on SNMP.
- *Log files and remote logging*: Alarms can be logged locally or passed to a remote logging server. See [chapter 27](#) for general information on event and alarm logging.
- *Status Relay*: On units equipped with a *Digital I/O* contact, the *status relay* pins (Digital-Out) can be used as an *alarm target*. Similar to the 'ON' LED, the status relay provides a *summary alarm* function, where the 'gate' is *closed* when the switch is operating 'OK', and *open* when any of the associated alarm triggers becomes active (or when the unit has no power).

See [section 25.4](#) for general information on the Digital I/O.

²As of WeOS v4.33.0 there is no support for SNMP traps for *timer* or *hardware* alarms.

- **'ON' LED:** There are front panel LEDs which can indicate status of specific ports or protocols. There is also a *general* status LED, which shows a *green* light when the unit is operating 'OK', but shows a *red* light as soon as any of the associated alarm triggers becomes active. Thus, the 'ON' LED provides a *summary alarm* function.

See [section 25.5](#) for general information on front panel LEDs.

- **Reboot:** (USE WITH CARE) The *reboot* target is used to make the unit to reboot upon a specified alarm event. The purpose is to provide a way to reboot the unit on a regular basis (i.e., by mapping a timer trigger to an action profile with *target reboot*, see [section 25.3.2.10](#)).

In addition, an operator can view the alarm status via the Web and CLI interfaces.

25.1.5.1 Summary alarm

The *summary alarm* in use by the *status relay* (digital-out) and *ON LED* targets assumes that every alarm trigger define the condition when the alarm is *active* ("alarm" situation) and *inactive* ("normal" situation).

- For many triggers this definition is implicit, e.g., a link alarm is active when the port (or interface) is *down* and inactive it is *up*.
- Other triggers, such as temperature or digital-in sensor triggers allow for the operator to define if the alarm is active: high or low temperature, voltage signal present or not present, etc. See [section 25.1.3.2](#), and in particular [figs. 25.2](#) and [25.3](#), for further information on the *active* and *inactive* trigger states.

Working as a summary alarm, the status relay as well as the ON LED will indicate 'alarm' as soon as any of the associated alarm triggers become active. For the ON LED alarm is indicated with a 'red' light, as shown in [fig. 25.4](#). For the status relay, alarm is indicated by having the gate in 'open' state. See [sections 25.4](#) and [25.5](#) for general information on Digital I/O and front panel LEDs.

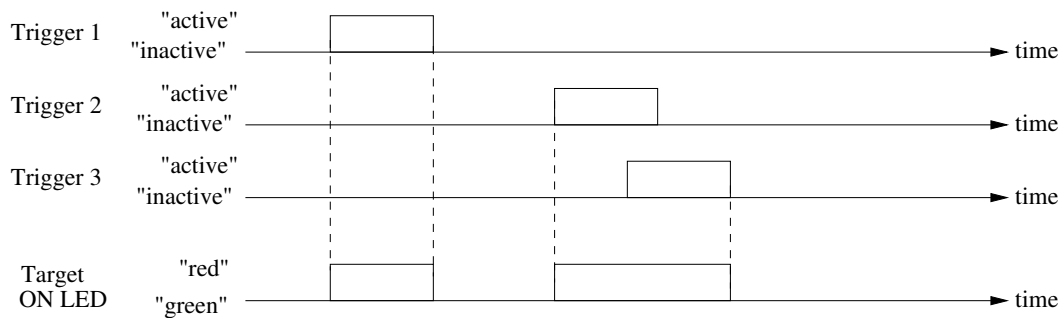

Figure 25.4: Summary alarm example with three alarm triggers mapped to the ON LED alarm target. The ON LED indicates 'alarm' (red) when any of the associated triggers are active.

25.2 Managing Alarms via the Web

25.2.1 Show alarm status

Alarm status is presented in the *System Overview* and the *Detailed System Overview* web pages, which are described in [sections 4.4](#) and [4.4.2](#).

[Fig. 25.5](#) shows the *System Overview* page when a *Link Alarm* is activated.

System Overview

Logged in as **admin** from 192.168.2.13

Hostname	redfox
Location	
Running Services	IGMP, IPConfig, LLDP, RSTP (non-root), SNMP, SSH
Uptime	4 days, 2 hours, 7 minutes, 26 seconds
Date	Mon Apr 22 13:21:14 2013
Alarms	link-alarm Port 2/3 DOWN
Interfaces	vlan1, 192.168.2.210 / 24

Auto-Refresh: Off, [5s](#), [15s](#), [30s](#), [60s](#)





Figure 25.5: The basic system overview page with a link alarm activated.

25.2.2 Trigger configuration overview page

Menu path: Configuration ⇒ Alarm ⇒ Triggers



When entering the Alarm configuration page you will be presented to a list of all alarm triggers configured on your unit, see below.

Alarm Triggers

Trigger	Class	Enabled	Action	Source		
1	frnt	✓	1	1		
2	power	✓	1	1, 2		
3	link-alarm	✓	1	1/1-1/2		

New Trigger

Figure 25.6: The alarm trigger configuration overview page.

Trigger	The index number of this trigger.
Type	The trigger type.
Enabled	A green check-mark means the trigger is enabled, and a dash means it is disabled.
Action	The index of the action profile associated with this trigger. The action profile controls what targets (LED, Status Relay (Digital Out), SNMP traps and/or Logging) to invoke for this alarm trigger.
Source	A list of alarm sources associated with this trigger. For link alarms, this is a list of port numbers, for a power alarm it is the identifiers for the associated power sensors, etc.
 Edit	Click this icon to edit a trigger.
 Delete	Click this icon to remove a trigger.
New Trigger	Click this button to create a new alarm trigger. You will be presented to a form where you can configure the new trigger.

25.2.3 Create a new alarm trigger using the web interface

Menu path: Configuration ⇒ Alarm ⇒ Triggers ⇒ **New Trigger**

When clicking the **New Trigger** button you will be presented to list of trigger types. Select the trigger type and click next to continue.



Figure 25.7: The trigger type selection page.

When clicking the **Next** button you will be presented to the **New trigger** page.

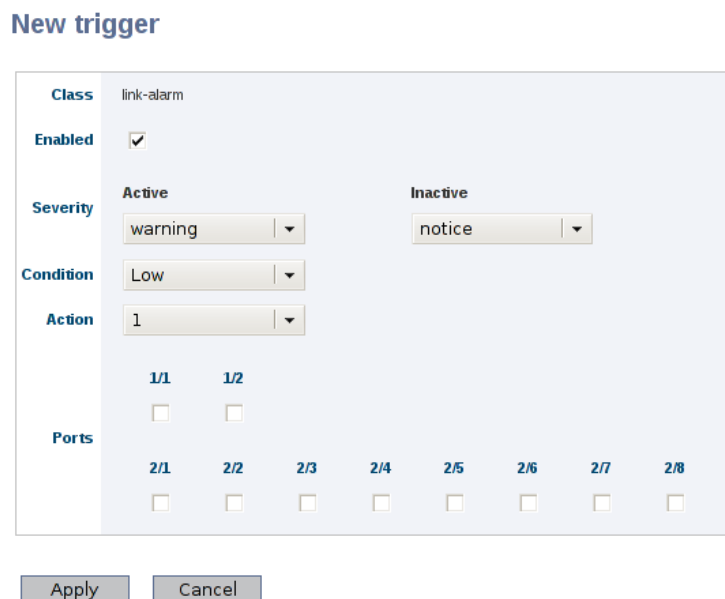

Figure 25.8: The alarm trigger creation page.

Type	The type of alarm trigger.
Continued on next page	

Continued from previous page	
Enabled	To enable the trigger - check the box, to disable un-check the box.
Severity Active	Severity level when active
Severity Inactive	Severity level when inactive
Condition	Controls the condition for triggering (High/low)
Sensors	The sensor source for this trigger
Threshold Rising	The Rising threshold is the higher threshold value for the sensor. When the current sample value is higher than this value, and the last sample was lower than this value, an action is triggered. Valid for none binary sensors such as temperature and SNR.
Threshold Falling	The falling threshold is the lower threshold value for the sensor. When the current sample value is less than this value, and the last sample was greater than this value, an action is triggered. Valid for none binary sensors such as temperature and SNR.
Initial State	The Initial state for the trigger, Ok or Warning. This only applies to ping.
Action	Selects the action for the trigger
Port	The ports on your switch is grouped as on the actual hardware, in slots. To get alarms for a a specific port, check the check-box located underneath the port label. In the picture above you see ports 1/1, 1/2 and 2/1 are marked as alarm sources for this link alarm trigger.

25.2.4 Create a new alarm trigger with sensor value

Triggers controlled by an analogue sensor, must be configure with threshold value. E.g. if you want to create a trigger that alarms if the temperature gets above a given temperature, you must set the rising threshold value to the alarm temperature. The falling thresholds may be set to the same value, but by using different thresholds (rising higher than falling) one can avoid receiving multiple events when the temperature fluctuates around the alarm threshold.

The screenshot shows a configuration form for a temperature alarm trigger. The form is organized into several sections:

- Class:** temperature
- Enabled:**
- Severity:** Active: warning (dropdown), Inactive: notice (dropdown)
- Condition:** High (dropdown)
- Sensors:** 1
- Temperature:** Rising threshold: 60 (input field), Falling threshold: 55 (input field)
- Action:** 1 (dropdown)

At the bottom of the form are two buttons: **Apply** and **Cancel**.

Figure 25.9: Example of a temperature trigger.

25.2.5 Action configuration overview page

Menu path: Configuration ⇒ Alarm ⇒ Actions

When entering the Alarm action configuration page you will be presented to a list of all alarm actions configured on your unit, see below.

Alarm Actions





Action	Targets	
1	SNMP-Trap, Log, LED, Status-Relay	 

Figure 25.10: The alarm action configuration overview page.

Action	The index number of this action.
Targets	The targets for this action.
 Edit	Click this icon to edit an action.
 Delete	Click this icon to remove an action.
New action	Click this button to add a new alarm action. You will be presented to a form where you can configure the new action.

25.3 Managing Alarms via the CLI

The table below shows alarm management features available via the CLI.

Command	Default	Section
<u>Configure Alarm Configuration Settings</u>		
alarm		Section 25.3.1
[no] trigger <<INDEX> <TYPE>>		Section 25.3.2
[no] enable	Enabled	Section 25.3.3
[no] <port <PORTLIST> sensor <SENSORIDLIST> ring <FRNT/MRP INSTANCE> timeout <TIMESPEC> peer <FQDN IPADDR> iface <IFNAME>		Section 25.3.4
[no] severity <<LEVEL> [active <LEVEL>] [inactive <LEVEL>]>		Section 25.3.5
condition <high low>		Section 25.3.6
threshold <NUM [rising <NUM>] [falling <NUM>]>	rising 0 falling 0	Section 25.3.7
[no] interval <SECONDS>		Section 25.3.8
[no] number <NUM>	3	Section 25.3.9
[no] outbound <IFNAME>	Disabled	Section 25.3.10
[no] initial-state <warning ok>		Section 25.3.11
[no] action <INDEX>	1	Section 25.3.12
show types		Section 25.3.13
[no] action <INDEX>		Section 25.3.14
[no] target <[log] [snmp] [led] > [digout] [reboot] [custom]>	log	Section 25.3.15
[no] custom <COMMAND>	Disabled	Section 25.3.16
[no] summary-trap		Section 25.3.17
<u>Alarm Status</u>		
alarm		Section 25.3.18
show		Section 25.3.19

25.3.1 Managing Alarm Settings

Syntax alarm

Context [Global Configuration](#) context

Usage Enter the Alarm Configuration context.

Use command **"show alarm"** to list an overview global alarm settings as well as configured alarm triggers and actions.

Default values Not applicable.

25.3.2 Manage Alarm Triggers

Syntax [no] trigger <<INDEX> | <TYPE>>

Context [Alarm Configuration](#) context

Usage Enter the Alarm Trigger Configuration to create, remove or update an alarm trigger.

- Use **"trigger <TYPE>"** to create a new trigger and enter the Trigger context, e.g., **"trigger link-alarm"** to create a new link-alarm trigger.

Use **"show types"** ([section 25.3.13](#)) to list supported trigger types.

An index will be assigned to each created index. This index can be used to update or remove the trigger, see items below.

- Use **"trigger <INDEX>"** to manage an existing trigger.
- Use **"no trigger <INDEX>"** to remove an existing trigger.

Use command **"show trigger"** to list configured alarm triggers. This is useful to find the index of a trigger, which is needed to edit or remove an existing trigger, see above.

Default values Not applicable.

Some examples of alarm trigger configurations are given in [sections 25.3.2.1-25.3.2.14](#). Details of individual alarm trigger configuration settings are given in [sections 25.3.3-25.3.12](#).

25.3.2.1 Link Alarm Trigger Configuration Example

Syntax trigger link-alarm

Context Alarm Configuration context

Usage Create a link-alarm trigger, and enter the [Alarm Trigger Configuration](#) context for this trigger.

Additional settings for link-alarm triggers are listed below. The only mandatory setting is the list of ports - no link-alarm alarm events will occur until ports are defined.

- Port(s) (mandatory): Define the port or ports this link-alarm trigger is associated with.
- Enable/Disable: By default, the trigger is enabled.
- Condition: By default, the alarm condition is set to *low*. That is, link-up is considered normal, and link-down is considered an alarm situation.
- Severity: By default, active severity is *WARNING* and inactive severity is *NOTIFY*.
- Action: By default, the trigger is mapped to the default action profile (action 1).

 **Example**

```
example:/#> configure
example:/config/#> alarm
example:/config/alarm/#> trigger link-alarm
Created trigger 2
example:/config/alarm/trigger-2/#> port 1-2
example:/config/alarm/trigger-2/#> end
example:/config/alarm/#> show
Trigger Type      Enabled Action Source
=====
      1 power        YES      1 1 2
      2 link-alarm   YES      1 1 2

Action Targets
=====
      1 snmp log led digout

=====
Summary alarm traps: Disabled
example:/config/alarm/#>
```

25.3.2.2 Digital-In Trigger Configuration Example

Syntax trigger digin

Context Alarm Configuration context

Usage Create a digital-in trigger, and enter the [Alarm Trigger Configuration](#) context for this trigger.

Additional settings for digital-in triggers are listed below.

- **Sensor:** By default, digital-in sensor with ID 1 is used. Use **"show env"** (in Admin Exec context) to list available sensors, see [section 7.3.44](#).
- **Condition:** By default, the alarm condition is set to *low*. That is, *high* is considered normal and *low* is considered an alarm situation.
- **Enable/Disable:** By default, the trigger is enabled.
- **Severity:** By default, active severity is *WARNING* and inactive severity is *NOTIFY*.
- **Action:** By default, the trigger is mapped to the default action profile (action 1).

 **Example**

```
example:/#> configure
example:/config/#> alarm
example:/config/alarm/#> trigger digin
Created trigger 2
example:/config/alarm/trigger-2/#> end
example:/config/alarm/#> show
Trigger Type      Enabled Action Source
=====
      1 power        YES      1 1 2
      2 digin        YES      1 1

Action Targets
=====
      1 snmp log led digout

=====
Summary alarm traps: Disabled
example:/config/alarm/#>
```

25.3.2.3 Power Trigger Configuration Example

Syntax trigger power

Context Alarm Configuration context

Usage Create a power trigger, and enter the [Alarm Trigger Configuration](#) context for this trigger.

Additional settings for power triggers are listed below. The only mandatory setting is the list of power sensors - no power alarm events will occur until power sensors are defined.

- **Sensor:** WeOS units typically have two power sensors; sensor 1 for DC1 and sensor 2 for DC2. Use **"show env"** (in Admin Exec context) to list available sensors, see [section 7.3.44](#).
- **Enable/Disable:** By default, the trigger is enabled.
- **Severity:** By default, active severity is *WARNING* and inactive severity is *NOTIFY*.
- **Action:** By default, the trigger is mapped to the default action profile (action 1).

 **Example**

```
example:/#> configure
example:/config/#> alarm
example:/config/alarm/#> trigger power
Created trigger 1
example:/config/alarm/trigger-1/#> sensor 1,2
example:/config/alarm/trigger-2/#> end
example:/config/alarm/#> show
Trigger Type      Enabled Action Source
=====
      1 power      YES      1 1 2

Action Targets
=====
      1 snmp log led digout

=====
Summary alarm traps: Disabled
example:/config/alarm/#>
```

25.3.2.4 SNR-Margin Trigger Configuration Example

Note, this setting only applies to units equipped with DSL ports.

Syntax trigger snr-margin

Context [Alarm Configuration](#) context

Usage Create a SNR-margin trigger, and enter the [Alarm Trigger Configuration](#) context for this trigger.

Additional settings for SNR-margin triggers are listed below. The only mandatory setting is the list of (DSL) ports - no snr-margin alarm events will occur until (DSL) ports are defined.

- **Port(s) (mandatory):** Define the port or ports this SNR-margin trigger is associated with.

Note: SNR-margin alarms can only be generated for ports where a connection has been established.

- **Alarm threshold:** As of WeOS v4.33.0 the SNR-margin falling threshold is set to 3 (dB) by default, and the rising threshold to 6 (dB) by default.
- **Enable/Disable:** By default, the trigger is enabled.
- **Condition:** By default, the alarm condition is set to *low*. That is, *high* is considered normal and *low* is considered an alarm situation.
- **Severity:** By default, active severity is *WARNING* and inactive severity is *NOTIFY*.
- **Action:** By default, the trigger is mapped to the default action profile (action 1).

In this example an SNR-margin trigger is created for DSL ports 1/1 and 1/2, with falling threshold 4 dB and rising threshold 6 dB.

 **Example**

```
wolverine:/#> configure
wolverine:/config/#> alarm
wolverine:/config/alarm/#> trigger snr-margin
Created trigger 2
wolverine:/config/alarm/trigger-2/#> port 1/1-1/2
wolverine:/config/alarm/trigger-2/#> threshold falling 4 rising 6
wolverine:/config/alarm/trigger-2/#> end
wolverine:/config/alarm/#> show
Trigger Type          Enabled Action Source
=====
      1 power           YES      1 1 2
      2 snr-margin      YES      1 1/1 1/2

Action Targets
=====
      1 snmp log led digout

=====
Summary alarm traps: Disabled
wolverine:/config/alarm/#>
```

25.3.2.5 Temperature Trigger Configuration Example

Syntax trigger temperature

Context Alarm Configuration context

Usage Create a temperature trigger, and enter the Alarm Trigger Configuration context for this trigger.

Additional settings for temperature triggers are listed below. The only mandatory setting is the temperature sensor (or list of sensors) - no temperature alarm events will occur until a sensor is defined.

- **Sensor(s):** Define the temperature sensor(s) this temperature trigger is associated with (default is temperature sensor is "1"). Use "**show env**" (in Admin Exec context) to list available sensors, see [section 7.3.44](#).
- **Alarm threshold:** As of WeOS v4.33.0 the temperature falling threshold and rising threshold are both set to 0°C by default.
- **Enable/Disable:** By default, the trigger is enabled.
- **Condition:** By default, the alarm condition is set to *high*. That is, temperatures below the falling threshold are considered normal, and temperatures above the rising threshold is considered an alarm situation.

- Severity: By default, active severity is *WARNING* and inactive severity is *NOTIFY*.
- Action: By default, the trigger is mapped to the default action profile (action 1).

In this example two temperature triggers are created, one to give alarm if the temperature drops below 10°C, and a second trigger to create an alarm if the temperature rises above 60°C.

 **Example**

```

example:/config/alarm/#> trigger temperature
example:/config/alarm/trigger-2/#> sensor 1
example:/config/alarm/trigger-2/#> threshold falling -10 rising -5
example:/config/alarm/trigger-2/#> condition low
example:/config/alarm/trigger-2/#> end
example:/config/alarm/#> trigger temperature
example:/config/alarm/trigger-3/#> sensor 1
example:/config/alarm/trigger-3/#> threshold falling 55 rising 60
example:/config/alarm/trigger-3/#> condition high
example:/config/alarm/trigger-3/#> end
example:/config/alarm/#> show
Trigger Type          Enabled Action Source
=====
      1 frnt           YES      1 1
      2 temperature YES      1 1
      3 temperature YES      1 1

Action Targets
=====
      1 snmp log led digout
=====
Summary alarm traps: Disabled
example:/config/alarm/#>
    
```

25.3.2.6 FRNT Trigger Configuration Example

Syntax trigger frnt

Context Alarm Configuration context

Usage Create a FRNT trigger, and enter the [Alarm Trigger Configuration](#) context for this trigger.

Additional settings for FRNT triggers are listed below.

- Ring: By default, FRNT ring ID 1 is used (as with FRNTv0 only one ring is supported, while more rings are supported with FRNTv2.) Use "**show env**" (in Admin Exec context) to list available sensors, see [section 7.3.44](#).
- Condition: By default, the alarm condition is set to *down* (or *low*). That is, ring status *up* (*high*) is considered normal and ring *down* (*low*) is considered an alarm situation.
- Enable/Disable: By default, the trigger is enabled.
- Severity: By default, active severity is *WARNING* and inactive severity is *NOTIFY*.
- Action: By default, the trigger is mapped to the default action profile (action 1).
- Examples:
The example below adds an FRNT trigger for a single instance.

 **Example**

```
example:/#> configure
example:/config/#> alarm
example:/config/alarm/#> trigger frnt
example:/config/alarm/trigger-2/#> end
example:/config/alarm/#> show
Trigger  Type      Enabled  Action  Source
-----  -
      1  power      YES      1  1 2
      2  frnt       YES      1  Ring 1

Action  Targets
-----  -
      1  snmp log led digout

Summary alarm traps: Disabled
example:/config/alarm/#>
```

It is possible to add additional FRNT triggers for other ring instances, see below.

 **Example**

```
example:/config/alarm/#> trigger 3 frnt
example:/config/alarm/trigger-3/#> ring-id 42
example:/config/alarm/trigger-3/#> end
example:/config/alarm/#> show
```

Trigger	Type	Enabled	Action	Source
1	power	YES	1	1 2
2	frnt	YES	1	Ring 1
3	frnt	YES	1	Ring 42

```
Action Targets
=====
1 snmp log led digout
=====
Summary alarm traps: Disabled
example:/config/alarm/#>
```

25.3.2.7 RiCo Uplink Trigger Configuration Example

Syntax trigger rico-uplink

Context Alarm Configuration context

Usage Create an RiCo uplink trigger, and enter the [Alarm Trigger Configuration](#) context for this trigger. This trigger applies both to RiCo and Dual-Homing uplinks.

Additional settings for RiCo uplink triggers are listed below.

- **Port:** One or more RiCo/Dual-Homing uplink ports can be set for the trigger.
- **Condition:** By default, the alarm condition is set to *down* (or *low*). That is, uplink status *up* (*high*) is considered normal and uplink status *down* (*low*) is considered an alarm situation.
- **Enable/Disable:** By default, the trigger is enabled.
- **Severity:** By default, active severity is *WARNING* and inactive severity is *NOTIFY*.
- **Action:** By default, the trigger is mapped to the default action profile (action 1).

 **Example**

```
example:/#> configure
example:/config/#> alarm
example:/config/alarm/#> trigger rico-uplink
example:/config/alarm/trigger-2/#> port 1/1
example:/config/alarm/trigger-2/#> end
example:/config/alarm/#> show
```

Trigger	Type	Enabled	Action	Source
1	frnt	YES	1	Instance 1
2	rico-uplink	YES	1	1/1

```
Action Targets
=====
1 snmp log led digout
=====
Summary alarm traps: Disabled
example:/config/alarm/#>
```

25.3.2.8 MRP Trigger Configuration Example

Syntax trigger mrp

Context Alarm Configuration context

Usage Create an MRP trigger, and enter the [Alarm Trigger Configuration](#) context for this trigger.

Additional settings for MRP triggers are listed below.

- Ring: By default, MRP ring ID 1 is used (as of WeOS v4.33.0 only a single MRP ring is supported, thus other values are invalid.) Use "**show env**" (in Admin Exec context) to list available sensors, see [section 7.3.44](#).
- Condition: By default, the alarm condition is set to *down* (or *low*). That is, ring status *up* (*high*) is considered normal and ring *down* (*low*) is considered an alarm situation.
- Enable/Disable: By default, the trigger is enabled.
- Severity: By default, active severity is *WARNING* and inactive severity is *NOTIFY*.
- Action: By default, the trigger is mapped to the default action profile (action 1).

 **Example**

```
example:/#> configure
example:/config/#> alarm
example:/config/alarm/#> trigger mrp
example:/config/alarm/trigger-1/#> end
example:/config/alarm/#> show
```

Trigger	Type	Enabled	Action	Source
1	mrp	YES	1	Instance 1

```
Action Targets
=====
1 snmp log led digout
=====
Summary alarm traps: Disabled
example:/config/alarm/#>
```

25.3.2.9 LFF Trigger Configuration Example

Note, this setting only applies to units equipped with SHDSL ports.

Syntax trigger lff

Context Alarm Configuration context

Usage Create a Link Fault Forward (LFF) trigger, and enter the [Alarm Trigger Configuration](#) context for this trigger.

Additional settings for LFF triggers are listed below. The only mandatory setting is the list of (SHDSL) ports - no LFF alarm events will occur until (SHDSL) ports are defined.

- **Port(s) (mandatory):** Define the port or ports this LFF trigger is associated with.
 Note: LFF alarms are generated both when detecting that the remote SHDSL switch indicated LFF, or when the SHDSL link is down.
- **Enable/Disable:** By default, the trigger is enabled.
- **Condition:** By default, the alarm condition is set to *low*. That is, *high* (remote link "up") is considered normal and *low* (remote link "down") is considered an alarm situation.
- **Severity:** By default, active severity is *WARNING* and inactive severity is *NOTIFY*.
- **Action:** By default, the trigger is mapped to the default action profile (action 1).

In this example an LFF trigger is created to monitor incoming LFF indications on SHDSL port 1/1.

 **Example**

```
wolverine:/config/alarm/#> trigger lff
wolverine:/config/alarm/trigger-2/#> port 1/1
wolverine:/config/alarm/trigger-2/#> end
wolverine:/config/alarm/#> show
```

Trigger	Type	Enabled	Action	Source
1	frnt	YES	1	1
2	lff	YES	1	dsl 1/1

```
Action Targets
=====
```

```
1 snmp log led digout
=====
Summary alarm traps: Disabled
wolverine:/config/alarm/#>
```

25.3.2.10 Timer Trigger Configuration Example

Syntax trigger timer

Context Alarm Configuration context

Usage Create a timer trigger, and enter the [Alarm Trigger Configuration](#) context for this trigger.

Additional settings for timer triggers are listed below.

- **Timeout time:** As of WeOS v4.33.0, only *daily* timeouts can be specified, e.g., "**timeout daily 02:30**"
- **Enable/Disable:** By default, the trigger is enabled.
- **Condition:** The condition setting has no meaning for a timer trigger, since as of WeOS v4.33.0 the timer trigger should not affect the *ON LED* or the *status relay* (Digital Out) action targets.
- **Severity:** By default, active severity is *WARNING* and inactive severity is *NOTIFY*.
- **Action:** By default, the trigger is mapped to the default action profile (action 1).

In this example a timer trigger is created to force a switch reboot daily at 02:30 in the morning.

 **Example**

```
example:/config/alarm/#> trigger timer
example:/config/alarm/trigger-2/#> timeout daily 02:30
example:/config/alarm/trigger-2/#> action 2
example:/config/alarm/trigger-2/#> end
example:/config/alarm/#> action 2
example:/config/alarm/action-2/#> target log reboot
example:/config/alarm/action-2/#> end
example:/config/alarm/#> show
Trigger Class      Enabled Action Source
=====
      1 frnt        YES      1 Instance 1
      2 timer        YES      2 daily 02:30

Action Targets
=====
      1 snmp log led digout
      2 log reboot

=====
Summary alarm traps: Disabled
```

25.3.2.11 Ping Trigger Configuration Example

Syntax trigger ping

Context Alarm Configuration context

Usage Create a ping trigger, and enter the [Alarm Trigger Configuration](#) context for this trigger. The ping trigger monitors the network connectivity (i.e., network reachability) to a given host, using the *ping* command.

Associated with the ping trigger are the following settings:

- *peer*: The host to test the connectivity against.
- *interval*: the ping *interval* can be configured (see [section 25.3.8](#))
- *number*: a *robustness threshold*, i.e., number of failed (or successful, depending on the *condition*) pings required to consider the remote host to be unreachable (or reachable), see [section 25.3.9](#))
- *outbound*: to force ping to use a specific interface. Useful with dynamic VRRP priority (see [section 32.1.1](#)), where you do not want to rely on the system default gateway.

In this example a ping trigger is created and mapped to the default action profile, to indicate alarm when the peer become unreachable after 3 retries.

 **Example**

```

example:/config/alarm/#> trigger ping
Trigger 2: Peer is mandatory
example:/config/alarm/trigger-2/#> peer bbc.co.uk
example:/config/alarm/trigger-2/#> number 3
example:/config/alarm/trigger-2/#> interval 3
example:/config/alarm/trigger-2/#> action 2
example:/config/alarm/trigger-2/#> end
example:/config/alarm/#> show
Trigger Type      Enabled Action Source
-----
1 frnt           YES      1 Instance 1
2 ping           YES      1 peer bbc.co.uk

Action Targets
-----
1 snmp log led digout

=====
Summary alarm traps: Disabled
example:/config/alarm/#>

```

In this example a ping trigger is created to trigger the status relay (digital out) when the peer become reachable, to do this change the condition argument (default: low).

Example

```
example:/config/alarm/#> trigger ping
Trigger 2: Peer is mandatory
example:/config/alarm/trigger-2/#> peer bbc.co.uk
example:/config/alarm/trigger-2/#> number 3
example:/config/alarm/trigger-2/#> interval 3
example:/config/alarm/trigger-2/#> condition high
example:/config/alarm/trigger-2/#> action 2
example:/config/alarm/trigger-2/#> end
example:/config/alarm/#> action 2
example:/config/alarm/action-2/#> target digout
example:/config/alarm/action-2/#> end
example:/config/alarm/#> show
```

Trigger	Type	Enabled	Action	Source
1	frnt	YES	1	Instance 1
2	ping	YES	2	peer bbc.co.uk

```
Action Targets
=====
1 snmp log led digout
2 log digout
=====
Summary alarm traps: Disabled
```

25.3.2.12 Address Conflict Trigger Configuration Example

Syntax trigger address-conflict

Context Alarm Configuration context

Usage Create an Address Conflict trigger, and enter the Alarm Trigger Configuration context for this trigger. Mandatory setting is the VLAN network interface to detect conflicts on. Optional setting is by what interval (1-300 seconds) active ARP probing for conflicts should run (default 60).

 **Note**
One VLAN interface per is allowed. Create an additional trigger activate address conflict detection on another VLAN.

- Interface: Set a valid VLAN interface, such as "**iface vlan1**". By default "**no iface**" is set, which implies inactive trigger. See [section 25.3.4](#).
- Interval: Set preferred sample interval in seconds (1-300). By default, 60 seconds. See [section 25.3.8](#)
- Severity: By default, active severity is *WARNING* and inactive severity is *NOTIFY*.
- Action: By default, the trigger is mapped to the default action profile (action 1).

 **Example**

```
example:/config/alarm/#> trigger address-conflict
example:/config/alarm/trigger-1/#> iface vlan1
example:/config/alarm/trigger-1/#> interval 100
example:/config/alarm/trigger-1/#> end
example:/config/#> show alarm
Trigger Type           Enabled   Action Source
=====
      1 address-conflict YES           1 vlan1

Action Targets
=====
1 snmp log led digout

=====
Summary alarm traps: Disabled
```

25.3.2.13 PoE Power Usage Trigger Configuration Example

Syntax trigger poe

Context Alarm Configuration context

Usage Create a PoE power usage trigger, and enter the [Alarm Trigger Configuration](#) context for this trigger. The power usage is defined as the percentage of consumed/maximum power.

Additional settings for temperature triggers are listed below. The only mandatory setting is the temperature sensor (or list of sensors) - no temperature alarm events will occur until a sensor is defined.

- Alarm threshold: Set the threshold to usage level (1-99 (%)) when an alarm is desired. By default, the rising threshold is set to 95(%) and the falling threshold to 90(%)
- Enable/Disable: By default, the trigger is enabled.
- Condition: By default, the alarm condition is set to *high*. That is, usage levels below the falling threshold are considered normal, and temperatures above the rising threshold is considered an alarm situation.
- Severity: By default, active severity is *WARNING* and inactive severity is *NOTIFY*.
- Action: By default, the trigger is mapped to the default action profile (action 1).

In this example a PoE trigger is created to give an alarm if the usage rises above 80%.

 **Example**

```
viper:/config/alarm/#> trigger poe
viper:/config/alarm/trigger-2/#> threshold rising 80 falling 75
viper:/config/alarm/trigger-2/#> condition high
viper:/config/alarm/trigger-2/#> end
viper:/config/alarm/#> show
```

Trigger	Type	Enabled	Action	Source
1	frnt	YES	1	Instance 1
2	poe	YES	1	1

```
Action Targets
=====
1 snmp log led
=====
```

Summary alarm traps: Disabled

```
viper:/config/alarm/#>
```

25.3.2.14 Microlok Trigger Configuration Example

Syntax trigger microlok

Context Alarm Configuration context

Usage Create a Microlok session summary alarm trigger, and enter the [Alarm Trigger Configuration](#) context for this trigger.

Additional settings for Microlok triggers are listed below. As of WeOS v4.33.0 there can only be one Microlok Gateway instance, thus the gateway instance (i.e., instance 1) is implicit.

- **Enable/Disable:** By default, the trigger is enabled.
- **Severity:** By default, active severity is *WARNING* and inactive severity is *NOTIFY*.
- **Action:** By default, the trigger is mapped to the default action profile (action 1).

Example

```
example:/config/microlok-1/#> map station 1a serial 1 session-timeout 2000
example:/config/microlok-1/#> map station 1b serial 1 session-timeout 2000
example:/config/microlok-1/#> map station 2a remote 192.168.2.1 session-
timeout 2000
example:/config/microlok-1/#> map station 2b remote 192.168.2.1 session-
timeout 2000
example:/config/microlok-1/#> end
example:/config/#> alarm
example:/config/alarm/#> trigger microlok
example:/config/alarm/trigger-2/#> action 2
example:/config/alarm/trigger-2/#> end
example:/config/alarm/#> action 2
example:/config/alarm/action-2/#> target log digout
example:/config/alarm/action-2/#> end
example:/config/alarm/#> show
Trigger  Type      Enabled  Action  Source
=====
      1  frnt         YES      1  Instance 1
      2  microlok     YES      2  1

Action  Targets
=====
      1  snmp log led digout
      2  log digout

=====
Summary alarm traps: Disabled
example:/config/alarm/#>
```

25.3.3 Enable/disable a Trigger

Syntax [no] enable

Context Alarm Trigger Configuration context

Usage Enable or disable an alarm trigger. A disabled trigger will keep its configuration settings, but will not affect any alarm targets.

Use **"enable"** to enable and **"no enable"** to disable a trigger.

Use **"show enable"** to show whether this trigger is *enabled* or *disabled*.

Default values Enabled

25.3.4 Manage alarm sources

Syntax [no] <port <PORTLIST> | sensor <SENSORIDLIST> |
ring <FRNT/MRP-INSTANCE> timeout <daily <HH:MM>>

Context Alarm Trigger Configuration context

Usage Specify which alarm sources the trigger should monitor. The command syntax differs depending on the trigger type:

- Use **"[no] port <PORTLIST>"** to specify which port(s) a *link-alarm* or *rico-uplink* trigger should apply to, e.g., use **"port 1/1,2/2-2/4"** to add ports 1/1, and 2/2-2/4 to the list of ports monitored by this trigger.
- Use **"[no] ring <INSTANCE>"** to specify which ring an FRNT/MRP alarm trigger should apply to.
- Use **"[no] sensor <SENSORIDLIST>"** to specify which sensors a *digital in*, *power* or *temperature* trigger should apply to, e.g., use **"sensor 1,2"** to add power sensors 1 and 2 to the list of power sensors monitored by this power trigger.

Use command `show env` (section 7.3.44) to list available sensors and their index values.

- Use **"[no] timeout <daily <HH:MM>>"** to specify how often and when an timer trigger should go off, e.g., use **"timeout daily 02:30"** to make the timer trigger to go off every day at 02:30 in the morning.
- Use **"[no] peer <FQDN|IPADDR>"** to specify the peer (domain name or IP address) to test the connectivity to.

"no peer" will delete the configured peer, however, having a *ping* trigger without a configured *peer* is not a valid setting.

- Use "[no] iface <IFNAME>" to configure the VLAN interface to enable address conflict detection on. This is a mandatory setting for Address Conflict triggers. When not set, or a non-valid VLAN interface is set, then *no iface* is written to configuration.

Use "no port <PORTLIST>" remove a specific set of ports, or "no port" to remove all ports from a trigger (the same goes for other source types).

If no sources are defined when exiting the trigger context, the trigger will automatically be configured as *disabled* (see [section 25.3.3](#)).

Use command "show " to show the alarm sources associated with this trigger. The type of alarm source differs depending on the trigger type. See [section 25.3.4](#) for more information.

Default values

25.3.5 Alarm Event Severity

Syntax [no] severity <<LEVEL>|[active <LEVEL>]|[inactive <LEVEL>]>

Context [Alarm Trigger Configuration](#) context

Usage Specify the severity level of *active* and *inactive* alarm events detected by this trigger. See [section 25.1.3.4](#) for information on available severity levels.

Active and inactive severity levels can be configured together or independently.

"no severity" will set severity to level *NONE*. Alarm events with severity *NONE* will not cause SNMP traps to be sent or events to be logged, however, such events can still affect the status relay (digital-out) and ON LED targets.

Use "show severity" to show the severity setting (*active* and *inactive* severity) for this trigger.

Default values active warning and inactive notice

The examples below show how to set severity level for active and inactive alarm events together and how to set it individually. The final example shows how to set severity 'NONE' for both active and inactive events.

Example

```
example:/config/alarm/trigger-2/#> severity err
example:/config/alarm/trigger-2/#> show severity
active err, inactive err
example:/config/alarm/trigger-2/#> severity inactive debug
example:/config/alarm/trigger-2/#> show severity
active err, inactive debug
example:/config/alarm/trigger-2/#>
example:/config/alarm/trigger-2/#> no severity
example:/config/alarm/trigger-2/#> show severity
active none, inactive none
example:/config/alarm/trigger-2/#>
```

25.3.6 Configure Alarm Condition Setting

Syntax condition <high|low>

Alternate keywords are possible:

- *rising* and *up* are equivalents to *high*.
- *falling* and *down* are equivalents to *low*.

Context [Alarm Trigger Configuration](#) context

Usage Define whether the *high* or *low* trigger state should be considered the *alarm state*, while the other is considered the *normal state*.

Some triggers, such as *power* triggers have a static (predefined) alarm condition setting. (Power triggers have *condition* set to *low*). For other triggers, the alarm condition setting is configurable.

See [section 25.1.3.2](#) for more information.

Use "**show condition**" to show the alarm condition setting for this trigger.

Default values Differs for different trigger types

25.3.7 Configure Rising and Falling Thresholds

Syntax threshold <NUM|[rising <NUM>]|[falling <NUM>]>

Context [Alarm Trigger Configuration](#) context

Usage Set falling and rising thresholds. The thresholds may be set to the same value, but by using different thresholds (rising higher than falling) one can

avoid receiving multiple events when the alarm source fluctuates around the alarm threshold.

Triggers which are *binary* to their nature, such as *link-alarm*, *power*, and digital-in triggers have implicit thresholds, which cannot be configured.

See [section 25.1.3.2](#) for more information.

Use command "**show threshold**" to show the trigger threshold setting (both *rising* and *falling* thresholds) for this trigger.

Default values rising 0 and falling 0 (except for *binary* alarm sources)

25.3.8 Configure Interval (Ping or Address Conflict)

Syntax [no] interval <SEC>

Usage There are more than one use for interval option: *Ping* trigger interval and *Address Conflict* trigger interval.

- *Ping trigger*: Specify the interval between ICMP Pings, i.e., interval at which ping messages are sent to probe the reachability to the peer.
- *Address Conflict*: Specify the interval between active check after conflicting addresses, i.e., interval at which ARP messages are sent to probe the VLAN for conflicting addresses.

Use command "**show interval**" to show the configured *interval* setting.

Use command "**no interval**" to reset interval to default.

Default values Differs:

- Ping trigger: 3 (seconds)
- Address Conflict trigger: 60 (seconds)

25.3.9 Configure Ping Robustness Number

Syntax [no] number <NUM>

Context [Alarm Trigger Configuration](#) context (ping trigger)

Usage Specify the number of ICMP ping that should be lost (or received) to determine if a host is unreachable (or reachable).

Use command **"show number"** to show the ping trigger robustness number setting, i.e., the number of pings required to be lost before the peer is considered unreachable, or the number of pings required to succeed before the peer is considered reachable.

25.3.10 Configure Ping Outbound Interface

Syntax [no] outbound <IFNAME>

Context [Alarm Trigger Configuration](#) context (ping trigger)

Usage Force pings to use a specific outbound interface. This is very useful when tracking upstreams connectivity in a VRRP dynamic priority scenario (see [section 32.1.1](#)). Because then you want to make sure the default gateway, or any other route, is avoided.

Use **"no outbound"** to disable the setting. This makes ping rely on network routes and fall back to use the *default gateway*.

Use command **"show outbound"** to show the configured *outbound interface* for this ping trigger. When unset, **"Default Gateway"** is shown and the system will use the system default route, or a matching network route, for ping packets.

Default values Disabled (default gateway)

25.3.11 Configure Initial State

Syntax [no] initial-state <warning|ok>

Context [Alarm Trigger Configuration](#) context (ping trigger)

Usage Set the initial alarm state for a trigger, this only applies to ping triggers.

Use command **"show initial-state"** to show the configured *initial-state*.

Default values Warning

25.3.12 Configure Trigger Action

Syntax [no] action <INDEX>

Context [Alarm Trigger Configuration](#) context

Usage Specify the action (profile) to be invoked when this trigger detects an alarm event.

Use **"no action"** to disable the mapping to an alarm action. E.g., when in use by another subsystem (e.g., VRRP with dynamic priority, see [section 32.1.1](#)), or if you simply want to temporarily disable or debug your alarms.

Use command **"show action"** to show the action profile mapped to this trigger.

Default values 1 (default action)

25.3.13 Show Supported Trigger Types

Syntax show types

Context [Alarm Configuration](#) context

Usage List supported trigger types. These are the types to be used with the **"trigger <TYPE>"** command (see [section 25.3.2](#)).

Default values Not applicable

25.3.14 Manage Alarm Actions

Syntax [no] action <INDEX>

Context [Alarm Configuration](#) context

Usage Create, remove or update an alarm action (profile). Use **"action <INDEX>"** to enter the Alarm Action Configuration context and create a new or update an existing action.

Use **"no action <INDEX>"** remove an existing action. The default action (index 1) cannot be removed, but you can disable all targets.

Use command **"show action"** to list all configured alarm action profiles, or **"show action <ID>"** to show detailed configuration information on a specific action profile (also available as **"show"** command within the Alarm Action Configuration of that profile).

Default values Not applicable.

25.3.15 Manage Action Targets

Syntax [no] target <[log] [snmp] [led] [digout] [reboot] [custom]>

Context Alarm Action Configuration context

Usage Add or remove alarm target to an alarm action (profile).

- led: Set ON/Status LED
- log: Log status change to syslog
- snmp: Generate an SNMP trap
- digout: Control the status relay (digital out)
- reboot: Reboot the unit. USE WITH CAUTION!
- custom: Run any admin-exec level command. DEPRECATED!



Warning

The **"custom"** target is for experimental purposes only! A .conf file containing **"target custom"** and **"custom reboot"** (see [section 25.3.16](#)) will be translated to **"target reboot"** automatically. That is to be backwards compatible. Other **"custom"** commands are not guaranteed to be supported in future releases.

Use command **"show target"** to show the alarm target(s) configured for this action profile.

Default values target log (New action profiles has **"target log"** as default.

25.3.16 Set Custom Action Target

Syntax [no] custom <COMMAND>

Context Alarm Action Configuration context

Usage Set custom action command. The custom target allows the user to connect, e.g., a timer trigger to a CLI Admin Exec level command, such as **"reboot"**, see [section 7.3.31](#).



Warning

This is a deprecated feature not guaranteed to be supported in future releases. For experimental purposes only!

Use **"no custom"** to remove a custom command.

Use command **"show custom"** to show the configured custom action command configured for this action profile.

Default values Disabled

Examples See [section 25.3.2.10](#).

25.3.17 Enable/disable Summary Alarm Traps

Syntax [no] summary-trap

Context [Alarm Configuration](#) context

Usage Enable or disable summary alarm traps. When enabled, a trap will be sent whenever the summary alarm status changes (from *OK* to *Warning* or vice versa). The summary alarm status follows the status of the *ON LED*. See also [section 6.1.3](#) for more information summary alarm status and its associated SNMP trap, and see [sections 25.1.5.1](#) and [25.3.15](#) for more information on the *ON LED* alarm target.

Use **"summary-trap"** to enable and **"no summary-trap"** to disable a SNMP traps for the summary alarm status.

Use **"show summary-trap"** to show whether summary alarm traps are *enabled* or *disabled*.

Default values Disabled



Example

```
example:#> configure
example:/config/#> alarm
example:/config/alarm/#> summary-trap
example:/config/alarm/#> show summary-trap
Enabled
example:/config/alarm/#> end
example:/config/#>
```

25.3.18 Handling Alarm Status

Syntax alarm

Context [Admin Exec](#) context

Usage Enter the Alarm Status context.

Default values Not applicable.

25.3.19 Show overall alarm status

Syntax show

Context [Alarm Status](#) context

Usage Show status of all alarms.

Default values Not applicable.

25.4 Digital I/O

WeOS products are typically equipped with a *Digital I/O* connector as the one shown in [fig. 25.11](#). The location of the connector differs between products; on RedFox Industrial it is located on the CPU card as shown in [fig. 25.12](#)).

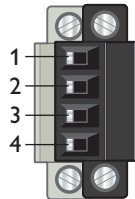

Figure 25.11: Digital I/O connector.

The Pin-Out of the Digital I/O connector is *typically* as follows:

Position	Description
1	Status +
2	Status -
3	Digital-In +
4	Digital-In -



Note

For a detailed specification on the Digital I/O connector (definite pin-out mapping, voltage levels, etc.), see the *User Guide* of your specific WeOS product ([section 1.5](#)).

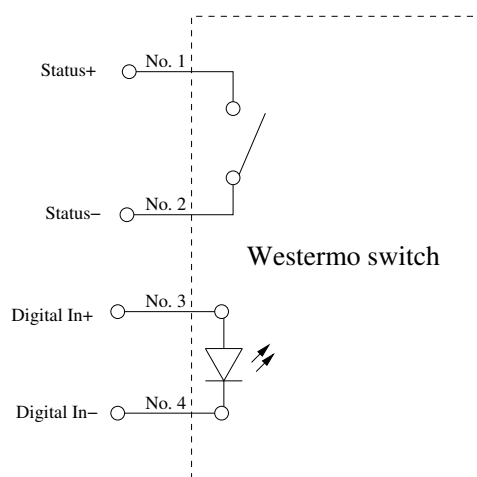

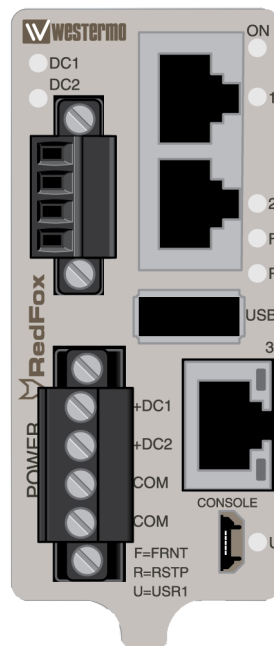

Figure 25.12: The Power and CPU module of a RedFox Industrial unit

As described in [section 25.1](#), *Digital-In* can be used as an alarm source, while the *Status Relay* (Digital-Out) is utilised as an alarm target (*summary alarm*).

- The Digital-In alarm is triggered when there is *lack of* voltage on the Digital-In pins. For information on appropriate voltage/current levels to trigger alarms via Digital-In, see the *User Guide* of your specific product ([section 1.5](#)).
- The Status Relay pins (Digital-Out) are internally connected to a *gate*. The gate is *open* when the switch has no power, or when any *alarm sources* are active. When the switch is operating normally (the switch has booted up, and no alarm source is active), the gate is *closed*.

25.5 LEDs

The LED functionality when running WeOS is described in the *User Guide* of your product (section 1.5). Here the information on LED functionality of *all* WeOS products is summarised. Note that your product may not have all LED types listed here.

LED	Status	Description
ON	OFF	Unit has no power
	GREEN	All OK, no alarm condition.
	RED	Alarm condition, or until unit has started up. (Alarm conditions are configurable, see sections 25.1-25.3.)
	GREEN BLINK	Location indicator ("Here I am!"). Activated when connected to WeConfig Tool, or upon request from Web, or when entering the CLI configuration context. Duration of blinking: 10 seconds.
	RED BLINK	Location indicator (see previous item) or indication of pending cable factory reset, see section 7.1.3.3.
DC1	OFF	Unit has no power.
	GREEN	Power OK on DC1.
	RED	Power failure on DC1.
DC2	OFF	Unit has no power.
	GREEN	Power OK on DC2.
	RED	Power failure on DC2.
AC1	OFF	Unit has no power.
	GREEN	Power OK on AC1.
DC ¹	OFF	Unit has no power.
	GREEN	Power OK on DC1 and DC2.
	RED	Power failure on DC1 or DC2.
DC ²	OFF	Unit has no power.
	GREEN	Power OK. Input voltage > 70% of minimum nominal voltage.
	RED	Power failure. Input voltage < 70% of minimum nominal voltage.
FRNT	OFF	FRNT disabled

Continued on next page

Continued from previous page		
LED	Status	Description
	GREEN RED BLINK	FRNT OK. (See also the <i>FRNT Error</i> item below.) FRNT Error. A focal point can detect and indicate local FRNT errors (FRNT link down) as well as FRNT errors elsewhere in the FRNT ring. A member switch only detects and indicates local FRNT errors (FRNT link down). Unit configured as focal point.
RSTP (formerly ST1)	OFF GREEN BLINK	RSTP disabled. RSTP enabled. Unit elected as RSTP/STP root switch.
USR1/VPN ³ (formerly ST2)	OFF GREEN RED	VPN disabled ⁴ . At least one VPN tunnel up and OK ⁴ . All VPN tunnels down ⁴ .
Ethernet ports	OFF GREEN GREEN FLASH YELLOW	No link. Link established. Data traffic indication. Port alarm, or port is set in blocking state by link redundancy protocol.
SHDSL ports	OFF GREEN GREEN BLINK GREEN FLASH YELLOW YELLOW BLINK	No SHDSL link. SHDSL link established. SHDSL link negotiation. Data traffic indication. Port alarm, or port is set in blocking state by link redundancy protocol. Only during unit startup. Firmware downloading to SHDSL chip.
SHDSL Link Quality Indicator	All OFF 3 RED 1 GREEN 2 GREEN 3 GREEN	No SHDSL link. SNR below 3 dB. Unstable SHDSL link. SNR 3-5 dB. Marginal SHDSL link. SNR 6-9 dB. Normal SHDSL link. SNR 10 dB or higher. Strong SHDSL link.
ADSL/ VDSL ports	OFF GREEN GREEN BLINK	No xDSL link. xDSL link established. xDSL link negotiation.
TD	OFF	No serial data received.
Continued on next page		

Continued from previous page

LED	Status	Description
RD	GREEN FLASH	Serial data received.
	YELLOW FLASH ⁵	Error on RS-422/485 bus.
	OFF	No serial data transmitted.
	GREEN FLASH	Serial data transmitted.

Additional explanations:

- BLINK means that the LED is blinking with a frequency about 1 Hz.
- FLASH means that the LED is blinking with a higher frequency.
- SHDSL LEDs only apply to products with SHDSL ports.
- xDSL (ADSL/VDSL) LEDs only apply to products with xDSL ports.
- TD and RD LEDs only apply to products with serial port(s). As the WeOS serial ports operate in DCE mode, TD denotes receiving, and RD denotes transmitting serial data.

¹Some Viper units (see the user guide of your product, listed in [section 1.5](#)) have two DC feeds (DC1 and DC2) with a *common* power indicator LED named "DC".

²Some Viper units (see the user guide of your product, listed in [section 1.5](#)) have a *single* DC feed with an indicator LED named "DC".

³The "USR1" LED is referred to as "VPN" or "ST2" on some older WeOS products.

⁴Only for products with software level WeOS Extended. As of WeOS v4.33.0, the USR1/VPN LED presents VPN status as described above. Alternative (configurable) use is intended but not yet supported.

⁵Only applicable for the DDW-x42-485[48] products.

Chapter 26

Port Monitoring

This chapter describes WeOS support for port monitoring.

Port monitoring in WeOS is persistent, i.e., as any other configured setting it is activated upon boot. It can therefore be used for troubleshooting purposes and for continuous mirroring of traffic to a recording device for later analysis.



Note

When configuring a port as *mirror port*, ensure that you are accessing your WeOS device via another port. Mirror ports become isolated, thus cannot be used to access your device.

26.1 Overview of Port Monitoring support

Feature	Web	CLI	General Description
Port Monitoring Support			
Configure Port Monitoring	X	X	Section 26.1.1

26.1.1 Port Monitoring

Port monitoring allows for mirroring of inbound/outbound traffic on one or more source ports to a destination port. Only *correct* Ethernet packets will be forwarded to the monitor destination port. To monitor occurrence of packet drops due to bad CRC, etc., we refer to the RMON statistics counters, see [chapter 11](#).

**Note**

To observe all traffic on the monitor source ports, the total amount of traffic on the monitor source ports should not exceed the capacity of the monitor destination port.

26.2 Port Monitoring in the Web

Menu path: Configuration ⇒ Port ⇒ Monitoring

Port Monitoring

Enabled

Destination Port (Mirror Port)

Source Ports (Sniff Ports)								Slot 1
Port	1/1	1/2						
	<input type="text" value="-"/>	<input type="text" value="Both"/>						
								Slot 2
Port	2/1	2/2	2/3	2/4				
	<input type="text" value="-"/>	<input type="text" value="-"/>	<input type="text" value="In"/>	<input type="text" value="Out"/>				
								Slot 3
Port	3/1	3/2	3/3	3/4	3/5	3/6	3/7	3/8
	<input type="text" value="-"/>	<input type="text" value="-"/>	<input type="text" value="-"/>	<input type="text" value="-"/>	<input type="text" value="-"/>	<input type="text" value="-"/>	<input type="text" value="-"/>	<input type="text" value="-"/>

Enabled	Check the box to enable port monitoring. If you have a JavaScript enabled browser the other settings will not be displayed unless you check this box.
Destination Port (Mirror)	Select one port to which data from source ports will be copied (mirrored).
Source Ports (Sniff Ports)	Select one or more ports to monitor by selecting the ports desired sniff mode. Available modes are: In Inbound (ingress) traffic. Out Outbound (egress) traffic. Both Both inbound and outbound traffic.

26.3 Port Monitoring via the CLI

Command	Default	Section
<u>Configuring Port Monitoring Settings</u>		
[no] monitor	Disabled	Section 26.3.1
[no] enable	Disabled	Section 26.3.2
[no] dst <PORT>		Section 26.3.3
[no] source <PORTLIST> [ingress] [egress]		Section 26.3.4
<u>Show Port Monitoring Status</u>		
show monitor		Section 26.3.5

26.3.1 Manage Port Monitoring

Syntax [no] monitor

Context [Global Configuration](#) context

Usage Use the **"monitor"** command to enter the Port Monitoring Configuration context.

"no monitor" will remove any existing port monitoring settings.

Use **"show monitor"** to show port monitoring settings (also available as **"show"** command within the Port Monitoring Configuration context).

Default values Disabled

26.3.2 Enable/disable Port Monitoring

Syntax [no] enable

Context [Port Monitoring Configuration](#) context

Usage Enable (activate) port monitoring. Use **"no enable"** to disable (deactivate) port monitoring.

Use **"show enable"** to list whether port monitoring is enabled or disabled.

Default values no enable (Disabled)

26.3.3 Set Mirror Port

Syntax [no] destination <PORT>

Context [Port Monitoring Configuration](#) context

Usage Set the monitor destination port, i.e., the *mirror* port.

Use "**show destination**" to show currently configured port monitoring destination port.

Default values By default there is no destination port.

26.3.4 Set Monitored Ports

Syntax [no] source <PORTLIST> [ingress] [egress]

Context [Port Monitoring Configuration](#) context

Usage Add/delete/update monitor source port(s), i.e., the ports being *monitored*.

Use "**show source**" to show current set of ports being monitored.

Default values By default there are no source ports. Commands apply both to "**ingress**" and "**egress**" if neither is specified.

26.3.5 Show Port Monitoring Status

Syntax show monitor

Context [Admin Exec](#) context

Usage Use the "**show monitor**" command to list the port monitoring status.

Default values Not applicable

Examples

Example

```
example:/#> show monitor
Mirror : Eth 8
Ports : Eth 10 inbound & outbound
example:/#>
```

Chapter 27

Logging

The system produces a wealth of information in log files. Most of the log messages generated in the system are that of general events from the various system components. For some of the more important events that are logged, see [section 27.1.3](#). In addition, configured alarm triggers (see [chapter 25](#)) can also be instructed to generate log messages.

The following types of methods for logging are available:

- *Logging of default log files:* By default all logs are written to an internal RAM disk. Log files written to the internal RAM disk are not persistent across reboots. See [section 27.1.2](#) for more information on default log files in the system.
- *Logging of default log files to USB:* When enabled it will log the same things that are logged to the internal RAM disk, but it will be done to a connected external USB drive.
- *Logging to console port:* It is possible to direct logging messages to the console port. Messages of severity level *DEBUG* or higher are shown on the console port.
- *Logging to custom logging sink:* For more advanced logging, including logging to *remote machines*, the system supports creation of user defined *logging sinks*. Each individual *sink* describes a logging target that can be either a remote logging server, a file on external media (USB), or a local file. In addition, for each sink the operator defines filters for what log messages to be written based on *Facility* (subsystem) and *Severity* (level). The filter provides a greater control in regards to the messages that should be logged.

27.1 Overview of Logging support

Feature	Web	CLI	General Description
<u>General Logging Configuration Settings</u>			
Enable/Disable Console Logging	X	X	Section 27.1.2
Enable/Disable USB Logging	X	X	Section 27.1.2
Enable/Disable Secure Mode	X	X	Section 27.1.4
Define Priority Templates	X	X	Section 27.1.5.3
Define Logging Sinks	X	X	Section 27.1.5
<u>Sink Configuration Settings</u>			
Target Destination	X	X	Section 27.1.5.1
Format Option	X	X	Section 27.1.5.2
Priority Filtering	X	X	Section 27.1.5.3
<u>Logging Status</u>			
Show Log Files	X	X	Section 27.1.2

27.1.1 Introduction to Logging

The system produces and presents a lot of information in the form of log messages that are stored in log files. Any message that is generated by the system will be associated with a so called *Facility* and a *Severity*, in accordance with the syslog standard specified in RFC 5424[10].

The *Facility* is supposed to signify what specific area any particular message belongs to. All facilities and how the system attempts to conform to them can be seen in [table 27.2](#).

#	Facility	Description
0	kern	Kernel log messages
1	user	User-level messages
2	mail	Unused
3	daemon	System daemons
4	auth	Security/Authorization messages
Continued on next page		

Continued from previous page		
5	syslog	Unused
6	lpr	Unused
7	news	Unused
8	uucp	Unused
9	cron	Unused
10	authpriv	Unused
11	ftp	Unused
12	ntp	NTP
13	security	Log audit, for audit trail
14	console	Log alert
16	local0	Alarm sub-system
17	local1	Macd "ATU Full" logs
18	local2	PPP
19	local3	Unused
20	local4	OpenVPN, IPsec
21	local5	Reserved, OEM customer specific
22	local6	Unused
23	local7	Unused

Table 27.2: All standard syslog facilities and their intended usage in the system.



Note

The facilities *security* and *console* are displayed as *LOGAUDIT* and *LOGALERT* in Wireshark, which is the de facto tool to debug all network traffic.

The *Severity* is supposed to represent the level of criticality for each individual message. All severities and how the system attempts to conform to them can be seen in [table 27.4](#).

#	Severity	Description
0	emerg	System level service only
Continued on next page		

Continued from previous page		
1	alert	System level service only
2	crit	System level service only
3	err	Severe error, daemon/service may restart
4	warning	Significant problem, e.g. no connection to Radius server
5	notice	General log message, e.g. login successful
6	info	Informational, less important
7	debug	Developer/low-level debug messages

Table 27.4: All standard syslog severities and their intended usage in the system.

As an example, a normal configuration setup for remote logging is to log all messages that fall within a specific severity and above. In the following example below, the device is configured to send all log messages of severity *notice* and above to a remote log server located at *foobar.example.com*.

 **Example**

```

example:/#> configure
example:/config/#> logging
example:/config/logging/#> sink
example:/config/logging/sink-1/#> target udp address foobar.example.com
example:/config/logging/sink-1/#> priority *.notice
example:/config/logging/sink-1/#> end
example:/config/logging/#> show sink
IDX  TARGET                                PRIORITY                                FORMAT
=====
1    udp address foobar.example.com  *.notice                                rfc3164
example:/config/logging/#> leave
example:/#>

```

27.1.2 Default Log Files

A number of different log files will be produced on the system by default and stored on a RAM disk. This functionality cannot be turned off, meaning that those log files will always be generated by the system. However, the same log files that are generated on the RAM disk can also be enabled to be generated to an attached USB drive, using the **"usb"** command in the logging configuration context.

Further, it is also possible to enable all log messages to be logged directly on the console terminal, using the **"console"** command in the logging configuration context. This could be useful when troubleshooting a potential problem, where instant logging feedback could help.

In order to see all local log files on the device, including custom local log files, the **"dir log"** command in the example below can be used.

```
Example
example:/#> dir log
=====
/log/ - Contents of Log File System
=====
quagga/
  0 1970-01-11 07:11 alarm
 236 1970-01-11 23:16 auth.log
  0 1970-01-11 07:11 cli
14538 1970-01-11 07:12 kern.log
  0 1970-01-11 07:11 mail.err
  0 1970-01-11 07:11 mail.log
24411 1970-01-11 23:23 messages<
 286 1970-01-11 07:12 ntp.log
  0 1970-01-11 07:11 openvpn.log
  0 1970-01-11 07:11 ppp.log
 90 1970-01-11 07:12 snmpd
38949 1970-01-11 23:23 syslog
=====
```

The *messages* log file is the main log file in the system. Use the **"show log"** to show it, without any additional input parameters it will display the *messages* log, as can be seen in the example below.

```
Example
example:/#> show log
Press Ctrl-C or Q(uit) to quit viewer, Space for next page, <CR> for next line.
Jan 11 07:11:53 default syslogd[492]: syslogd v2.1.1: restart.
Jan 11 07:11:53 default kernel: finit[1]:Starting watchdogd, PID: 491
Jan 11 07:11:53 default kernel: finit[1]:Starting syslogd, PID: 492
[...]
```

In order to show a specific log file include the name of it in the command, as done below.

Example

```
example:/#> show log://auth.log  
Press Ctrl-C or Q(uit) to quit viewer, Space for next page, <CR> for next line.  
Jan 11 23:16:54 example login[677]: Authentication successful for user 'admin'  
[...]
```

When viewing particularly large log files, remember the short-keys to the **"show"** command:

- *R*: Show the rest of the file.
- *Q*: Quit the viewer.

Also, the **"follow"** command is very useful when monitoring log files. It continuously lists new lines as they are appended to a file. Use **"Ctrl-C"** to stop and return to the command prompt.

27.1.3 Security Related Events

As mentioned the system produces a lot of different log messages, but there are a number of messages identified as being more important in terms of security. In [table 27.5](#) below, a number of different events have been listed that produces a specific log message. It lists the *Facility* and *Severity* along with an example how the generated message could look like.

Event	Facility	Severity	Example
Login successful	auth	notice	Authentication successful for user 'admin' from 10.0.0.1
Login failed	auth	warning	Authentication failed for user 'admin' from 10.0.0.1
Audit trail	security	notice	User 'admin' changed the configuration
System startup	console	notice	\\ Westermo WeOS v4.29.0, entering runlevel 2
System shutdown	console	notice	\\ Westermo WeOS v4.29.0, entering runlevel 6
Enter Maintenance mode	user	notice	Entering maintenance mode for upgrade to WeOS-4.29.0.pkg ...
Exit Maintenance mode	user	notice	Exiting maintenance mode for upgrade
Service start	console	notice	Starting syslogd, PID: 1203
Service stop	console	notice	Stopping syslogd, PID: 1203, sending SIGTERM...
Service restarting	console	notice	Restarting syslogd, PID: 1203, sending SIGHUP...
Service Died	console	warning	Service syslogd died, restarting 1
Link up	console	notice	Link up on port Eth 1
Link down	console	notice	Link down on port Eth 1
DHCP Unknown host ID	console	notice	DHCPDISCOVER(vlan1) 11:22:33:44:55:66 no address available
NTP Sync	ntp	notice	Selected source 192.111.0.2
NTP Sync Fail	ntp	warning	Receive timeout for [192.111.0.2:123]
Continued on next page			

Continued from previous page			
Firewall allow	security	notice	FW-ALLOW: IN=vlan1 OUT=vlan2 MAC=[...] SRC=[...] DST=[...] [...]
Firewall deny	security	notice	FW-DENY: IN=vlan1 OUT=vlan2 MAC=[...] SRC=[...] DST=[...] [...]
Firewall nat 1to1	security	notice	FW-1TO1: IN=vlan1 OUT=vlan2 MAC=[...] SRC=[...] DST=[...] [...]
Firewall nat natp	security	notice	FW-NAPT: IN=vlan1 OUT=vlan2 MAC=[...] SRC=[...] DST=[...] [...]
Firewall port forward	security	notice	FW-PF: IN=vlan1 OUT=vlan2 MAC=[...] SRC=[...] DST=[...] [...]
PNAC success	auth	notice	IEEE 802.1X: authenticated
PNAC fail	auth	warning	IEEE 802.1X: unauthorizing port

Table 27.5: Security related events that are logged in the system

27.1.4 Secure Mode

By default the logging service operates in *Secure Mode*. This means that the system will not accept any messages directed to it from any other remote machines; it only considers its own (local) events.

However, if the device should be able to receive log messages from other devices, secure mode can simply be disabled. Secure mode can be enabled or disabled using the "[no] **secure-mode**" in the logging configuration context.



Note

When *Secure Mode* is changed the entire logging service on the system requires a restart. Potentially, some log messages could be missed during the time it takes for the logging service to fully restart.

27.1.5 Logging Sink

A *Logging Sink* defines a specific logging destination that includes a filter based on *Facility* and *Severity*, specifying what messages should be sent to the sink's target destination. The ability to create *Logging Sinks* provides the possibility to create more advanced logging setups, since partial filtering of log messages can be performed on the device.

27.1.5.1 Target Destination

Each individual *sink* is associated with a specific target destination. The following configuration options exist for configuring a sink's target destination:

- *UDP*: Log to a remote target destination:
 - *Address*: Log to a remote target destination, specified by providing an IP address "**target udp address 10.0.0.1**" or and FQDN "**target udp address my.fqdn**".
 - *DHCP*: Obtain an IP address to a remote target destination using DHCP (option 7) "**target udp dhcp**". If a lease is obtained on any interface that also provides a log server (option 7), a sink will be created to log towards the IP address provided.
- *File*: Log to a specific file:
 - *Internal*: Specify a local file "**target file internal my.file.path**" to log to on the RAM disk of the device.
 - *External*: Specify a file "**target file external my.file.path**" to log to an attached external media e.g. a USB.

27.1.5.2 Format Option

The formatting of the log messages written by the sink can be configured using the "**format**" command in the sink configuration context. Three different formatting types are supported:

- *BSD*: Format used before the official standardization of syslog.

Example

```
myproc[8710]: Kilroy was here.
```

- *Rfc3164*: Format based on the rfc3164 standard.

Example

```
Aug 24 05:14:15 192.0.2.1 myproc[8710]: Kilroy was here.
```

- *Rfc5424*: Format based on the rfc5424 standard.

Example

```
2003-08-24T05:14:15.000003-07:00 192.0.2.1 myproc 8710 - - Kilroy was here.
```

27.1.5.3 Priority Filtering

The priority filtering dictates what messages the sink should send towards its destination, it is configured using the "**priority**" command in the sink configuration context. The priority is defined based on expressions consisting of a facility, a modifier and a severity. The priority setting can consist of multiple different expressions. The existing expression modifiers can be seen in [table 27.7](#).

An example of how to configure a sink priority to include all messages from the auth, security, console and ntp facilities is shown below.

Example

```
example:/config/logging/sink-1/#> priority auth.*
example:/config/logging/sink-1/#> priority security.*
example:/config/logging/sink-1/#> priority console.*
example:/config/logging/sink-1/#> priority ntp.*
```

The same configuration as a *one-liner*:

Example

```
example:/config/logging/sink-1/#> priority auth;security;console;ntp
```

Modifier	Usage	Description
.	<i>facility.severity</i>	Include messages of facility with severity <i>equal or greater</i>
.!	<i>facility.!severity</i>	Exclude messages of facility with severity <i>equal or greater</i>
. =	<i>facility. = severity</i>	Include messages <i>equal</i> to this facility and severity
.! =	<i>facility.! = severity</i>	Exclude messages <i>equal</i> to this facility and severity
.	<i>.severity</i>	Include <i>all</i> messages of a severity
.*	<i>facility.*</i>	Include <i>all</i> messages of a facility
.	<i>*.*</i>	Include <i>all</i> messages of any facility or severity

Table 27.7: All of the expression modifiers that can be used when creating sink priority expressions.



Note

Another thing to keep in mind, ordering of the expression have an effect on how the filtering is applied. In order to utilize an exclude rule, for instance, something must have been defined before it to be excluded from. Meaning that expressions are processed in the order that they appear, i.e. the order they are added.

As an example an expression **"*.*"** is added specifying that all messages are to be logged, of any facility and severity. If additional rules, say **"auth.*"** and **"authpriv.*"**, are added this means that we will now exclude all messages with the auth and authpriv facility based on preceding expression rules. If we would have added the exclude rules first it would not do anything, since no base to exclude them from existed.

Further, it is possible to create templates, or use any of the predefined templates, to make it easier to define sink priorities. Custom templates can be created using the **"template"** command in the logging configuration context. An example of how to apply a template to a sink priority can be seen below.

Example

```
example:/config/logging/sink-1/#> priority template debug
```

Note

The template used has no association with the sink priority it is applied to, meaning that it simply applies the priority expressions from the template onto the sink priority. If the template is changed, the changes will not be applied to any sink that the template was used on.

27.2 Managing Logging via the Web

The Web interface provides configuration management of the Logging in the system.

27.2.1 Logging Settings





Menu path: Configuration ⇒ System ⇒ Logging

Logging

Console syslog	Disabled		
USB Logging	Disabled	Count: 10M	Size: 10
Secure Mode (reject incoming)	Enabled		





Apply Cancel

Sink

ID	Target	Priority	Option	
1	192.168.1.100	*.*;auth.none;authpriv.none;cron.none;ker...	rfc3164	 
2	my-file.log	auth.*;authpriv.*;security.*	rfc5424	 



New Sink

Priority Template

ID	Name	Priority	
1	security	auth.*;authpriv.*;security.*	 (*)
2	debug	*.debug;auth.!debug;authpriv.!debug;security.!debug	 (*)
3	common-events	auth.notice;security.notice;console.notice;user.notice;ntp.notice	 (*)
4	messages	*.*;auth.none;authpriv.none;cron.none;kern.none;mail.none;news.none	 (*)

New Priority Template

(*)Built-in template cannot be edited, a copy will be created.

Console syslog	Select from the drop-down whether to enable or disable logging of all messages directly on the console .
USB Logging	Select from the drop-down whether to enable or disable logging of default log files to USB.
Secure Mode	Select from the drop-down whether to enable or disable secure mode. When enabled we will operate in a secure mode, meaning we will not accept any messages from other machines. If disabled, we can receive messages and log messages from other machines.
Sink	Lists the configured logging sinks. To add a new sink click on the New Sink button below the table. Click on the Edit icon () to edit the settings for a specific sink. Clicking the edit icon or the "New Sink" button will take you the "Create/Edit Logging Sink" page, see section 27.2.2 .
Priority Template	Lists the configured and default priority templates. To add a new priority template click on the New Priority Template button below the table. Click on the Edit icon () to edit the settings for a specific priority template. Clicking the edit icon or the "New Priority Template" button will take you the "Create/Edit Priority Template" page, see section 27.2.3 .

27.2.2 Create/Edit Logging Sink Settings

Menu path: Configuration ⇒ System ⇒ Logging ⇒ New Sink

Menu path: Configuration ⇒ System ⇒ Logging ⇒  (Sink)

Edit sink 1

General

ID	1	
Target	UDP / Address ▼	192.168.1.100
Message Format	RFC3164 ▼	

Priority

Expr	Facility	Modifier	Severity	
1	* ▼	. ▼	notice ▼	
<input type="button" value="Add Priority"/> Use template None ▼				

General	<p>General sink settings:</p> <p>ID Numeric ID of the sink.</p> <p>Target Specify the logging target destination for the sink.</p> <p>Message Format Specify what format should be used for the messages logged by the sink.</p>
Priority	Priority expression definition, what messages to be logged by the sink:
Continued on next page	

Continued from previous page

Expr Numeric ID of the expression.

Facility Facility of the expression.

Modifier Expression modifier.

Severity Severity of the expression.

See [Section 27.1.5.3](#) for more information on priority expressions.

Use the **Add Priority** button to add a new expression or use **Use template** to select a template to import onto the priority expression.

27.2.3 Create/Edit Priority Template Settings

Menu path: Configuration ⇒ System ⇒ Logging ⇒ New Priority Template

Menu path: Configuration ⇒ System ⇒ Logging ⇒  (Priority Template)

New Priority Template

Id	NA		
Name	<input type="text"/>		
Expr	Facility	Modifier	Severity
1	kern	.	emerg
<input type="button" value="Add 2nd"/>			
<input type="button" value="Apply"/>		<input type="button" value="Cancel"/>	

General	<p>General template settings:</p> <p>ID Numeric ID of the template.</p> <p>Name Name of the template, this is used when it is applied to a sink priority configuration.</p>
Priority	<p>Priority expression definition, what messages to be logged by the sink:</p> <p>Expr Numeric ID of the expression.</p> <p>Facility Facility of the expression.</p> <p>Modifier Expression modifier.</p> <p>Severity Severity of the expression.</p> <p>See Section 27.1.5.3 for more information on priority expressions.</p>

27.2.4 View Log Files

Select the log file in the drop down list and press **View** to the display desired log file.

Menu path: Maintenance ⇒ View Log

View Log

Please select the log file to be displayed.

(none)

No file selected.

Select the log file in the drop down list and press **View** to the display desired log file.

View Log

Please select the log file to be displayed.

messages

```
Sep 28 14:50:32 redfox pluto[565]: Changing to directory '/etc/ipsec.d'
Sep 28 14:50:32 redfox pluto[565]: Changing to directory '/etc/ipsec.d'
Sep 28 14:50:32 redfox pluto[565]: added connection description "ipsec0"
Sep 28 14:50:32 redfox pluto[565]: listening for IKE messages
Sep 28 14:50:32 redfox pluto[565]: adding interface lo/lo 127.0.0.1:500
Sep 28 14:50:32 redfox pluto[565]: adding interface lo/lo ::1:500
Sep 28 14:50:32 redfox pluto[565]: listening for IKE messages
Sep 28 14:50:32 redfox pluto[565]: forgetting secrets
Sep 28 14:50:32 redfox pluto[565]: forgetting secrets
Sep 28 14:50:32 redfox pluto[565]: "ipsec0": deleting connection
Sep 28 14:50:32 redfox pluto[565]: added connection description "ipsec0"
Sep 28 14:50:33 redfox udhcpc[863]: Lease of 192.168.2.91 obtained, lease time 259200
Sep 28 14:50:34 redfox ntpclient[454]: Time synchronized to server 192.168.2.3, stratum 3
Sep 28 14:50:35 redfox pluto[565]: listening for IKE messages
Sep 28 14:50:35 redfox pluto[565]: adding interface vlan1/vlan1 192.168.2.91:500
Sep 28 14:50:35 redfox pluto[565]: forgetting secrets
Sep 28 14:50:35 redfox pluto[565]: forgetting secrets
Sep 28 14:50:35 redfox pluto[565]: "ipsec0": deleting connection
Sep 28 14:50:35 redfox pluto[565]: added connection description "ipsec0"
Sep 28 14:50:38 redfox web[953]: Authentication successful for user 'admin'.
```

[Show in new window](#) [Download](#)

27.3 Managing Logging via the CLI

Command	Default	Section
<u>Configuring Logging Settings</u>		
[no] logging	Disabled	Section 27.3.1
[no] console	Disabled	Section 27.3.2
[no] usb [SIZE [COUNT]]	Disabled	Section 27.3.3
[no] secure-mode	Enabled	Section 27.3.4
[no] template NAME [EXPR [;EXPR]]	N/A	Section 27.3.5
[no] sink [INDEX]	1	Section 27.3.6
[no] target <udp <address <IP FQDN> dhcp> file <internal external> PATH>	N/A	Section 27.3.7
[no] format <bsd rfc3164 rfc5424>	rfc3164	Section 27.3.8
[no] priority <EXPR [;EXPR...] template NAME>	N/A	Section 27.3.9
<u>Managing Log Files</u>		
dir <cfg:///log:///usb://>		Section 7.3.25
copy <FROM_FILE> <TO_FILE>		Section 7.3.26
erase <FILE>		Section 7.3.27
show <running-config startup-config factory-config [<fileys>://]FILENAME>		Section 7.3.28

27.3.1 Managing Logging Settings

Syntax [no] logging

Context [Global Configuration](#) context

Usage Enter Logging Configuration context.

Use **"no logging"** to disable all logging, console and usb logging as well as removing all configured logging sinks.

Use **"show logging"** to show logging configuration settings. Also available as **"show"** command within the Logging Configuration context.

Default values Disabled

**Note**

The logging to the systems default log files on the internal RAM disk cannot be disabled.

27.3.2 Logging to console port

Syntax [no] console

Context [Logging Configuration](#) context

Usage Enable or disable console logging.

Use **"console"** to enable console logging, and **"no console"** to disable console logging.

When enabled, general events detected by the system, as well as alarm events associated with configured alarm triggers, will be presented on the console port.

Use **"show console"** to show whether console port logging is enabled or disabled.

Default values *Disabled*

27.3.3 Logging of default log files to USB

Syntax [no] usb [SIZE [COUNT]]

Context [Logging Configuration](#) context

Usage Enable or disable logging of default log files to USB . When enabled the same log files that are created on the local RAM disk (see [section 27.1.2](#)) will also be created on the attached USB drive.

Use **"usb"** to enable usb logging. Optional settings for specifying log rotation:

SIZE Max size of each log file, in uncompressed form. Takes an optional k/M size modifier.

COUNT Number of log files to keep, in total.

Note

The log rotation configuration applies to each individual log file that is created, as per the systems default log files.

If no explicit **"SIZE"** and **"COUNT"** is specified they will use the default value of 10M and 10 respectively.

To Disable USB logging use the **"no usb"** command.

Use **"show usb"** to show whether usb logging is enabled or disabled and what size and count has been configured.

Default values *Disabled*

Note

Sinks can be configured to log to a USB file, regardless if this setting is enabled or not. This setting only handles logging of the systems default log files to the USB.

27.3.4 Disable Secure Mode

Syntax [no] secure-mode

Context [Logging Configuration](#) context

Usage Enable/disable secure mode. This setting determines whether the unit reject or accept any logging messages from remote machines. By default secure mode is enabled, meaning the unit operates in a secure way and do not accept any messages from remote machines.

Use **"no secure-mode"** to disable secure mode and **"secure-mode"** to enable it.

Use **"show secure-mode"** to show whether secure mode logging is enabled or disabled.

Default values *Enabled*

27.3.5 Configure Priority Template

Syntax [no] template NAME priority [EXPR [;EXPR]]

Context [Logging Configuration](#) context

Usage Manage syslog sink priority templates.

EXPR := facility.[!|=]severity

facility := [auth | console | daemon | kern | ntp | security |
user | local0 .. local7]

severity := [debug | info | notice | warning | err | crit |
alert | emerg]

Use **"no template"** to remove all templates, except for default templates (default templates are not removable). Use **"no template NAME"** to remove a specific template.

Use **"show template"** to show all the existing templates.

Default values N/A

27.3.6 Configure Logging Sink

Syntax [no] sink [INDEX]

Context [Logging Configuration](#) context

Usage Enter the Logging Sink Configuration context to specify and manage logging sinks. Each sink defines a logging destination and filter on what messages to send towards the destination based on log message *Facility* and *Severity*. Each sink is given an index (default 1) e.g., **"sink 2"** will enter the Logging Sink Configuration configuration context for sink 2. If does not exist yet it will be created.

Use **"no sink"** to remove all configured logging sinks, and use **"no sink <INDEX>"** to remove a specific sink definition (e.g. **"no sink 3"**).

Use **"show sink"** to show a list of all configured logging sinks, and use **"show sink <INDEX>"** to show information on a specific sink. Alternatively, you can run the **"show"** command within the Logging Sink Configuration context of that specific sink.

Default values *Default index is 1.*

27.3.7 Configure Sink Target

Syntax [no] target <udp <address <IP|FQDN> | dhcp> |

```
file <internal|external> PATH>
```

Context [Logging Sink Configuration](#) context

Usage Specify the target destination of the sink. The target can specify the following types of destinations for the sink:

- *File on local RAM disk:* Use **"target file internal my-file-path"** to log to a local file specified by a file path, relative to the systems log file folder.
- *File on USB drive:* Use **"target file external my-file-path"** to log to a file on the connected USB, specified by a file path relative to the USB.
- *Remote machine:* Specify a remote machine to log to by providing an IP address **"target udp address 10.0.0.1"** or and FQDN **"target udp address my.fqdn"**.
- *Remote machine (Dynamic):* Use **"target udp dhcp"** to specify that the sink should log to a remote machine specified by an IP address received from a DHCP lease providing a log server (DHCP Option 7). To configure a WeOS DHCP Server to provide a log server (Option 7) see [section 23.3.6](#) and [section 23.3.18](#).

A target is required for every sink. Therefore, it is not possible to remove, it can only be changed by configuring another target.

Use **"show target"** to show the currently configured sink target destination.

 **Note**

Multiple different sink instances cannot share the same target destination, it needs to be unique per sink. Further, if a udp sink is configured with an IP address that turn out to be the same as one received from a dynamic sink configured to receive a remote server IP address over DHCP, the udp sink will take precedence.

Default values N/A

27.3.8 Configure Sink Format

Syntax [no] format <bsd|rfc3164|rfc5424>

Context [Logging Sink Configuration](#) context

Usage Specify what formatting should be used when generating log messages.

The following formatting options exist:

- *BSD*: Legacy formatting for remote syslog servers.

 **Example**

```
<PRI> message
```

- *RFC3164*: Standardized formatting.

 **Example**

```
<PRI>Nov 18 09:36:42 hostname proc[123] message
```

- *RFC5424*: Modern syslog formatting.

 **Example**

```
<PRI>1 2019-11-18T09:36:42.000321+01:00 hostname proc 123 - - message
```

Use **"no format"** to reset the configuration of the setting to its default value.

Use **"show format"** to show the currently configured formatting option.

Default values *rfc3164*

27.3.9 Configure Sink Priority

Syntax [no] priority <EXPR [;EXPR] | template NAME>

Context [Logging Sink Configuration](#) context

Usage Configure syslog priority expressions, specifies what messages to log.

Each expression consists of a facility, a modifier, and a severity. These expressions are combined to define the syslog priority, which in turn dictate what type of messages are sent towards the sink target destination.

EXPR := facility.[!|=]severity

facility := [auth | console | daemon | kern | ntp | security |
user | local0 .. local7]

severity := [debug | info | notice | warning | err | crit |
alert | emerg]

For more information on how to define syslog priorities see [section 27.1.5.3](#).

It is also possible to use a priority template when specifying the sink's priority, using the "**priority template**" command.

Use the command "**no priority**" to remove all defined expressions. Use "**no priority EXPR**" to remove that specific expression from the priority definition.

Use "**show priority**" to show all configured priority expressions.

Default values N/A

Part III

Router/Gateway Services

Chapter 28

IP Routing in WeOS

In addition to *switching* (layer-2), WeOS devices (with proper WeOS level) are able to *route* data packets (layer-3), i.e., they are *routing switches*. The WeOS routing support includes static routing and dynamic unicast routing via OSPF and RIP, static multicast routing, as well as other useful router features such as firewall, NAT, and VRRP.

This chapter introduces the IP routing capabilities in WeOS in general. More information on dynamic routing is found in [chapters 29](#) (OSPF) and [30](#) (RIP), while static multicast routing support is described in [chapter 31](#). Supplementary router services are covered in the chapters to follow: VRRP in [chapter 32](#), and firewall and NAT in [chapter 33](#).

Support for VPN and tunneling techniques are presented separately, see [part IV](#).

28.1 Summary of WeOS Routing and Router Features

[Table 28.1](#) presents the routing and router features available in WeOS.

28.1.1 Introduction to WeOS Routing and Router Features

IP routing enables us to connect our networks together, and to let (TCP/IP) devices communicate across networks of different type and topology, and possibly over multiple network "hops" and long distances. A router looks at the destination IP address carried within each IP packet, consults its *routing table* to make a routing decision, and forwards the packet onto the next router in the path to the destination.

Feature	Web	CLI	General Description
Enable/disable routing	X	X	Section 28.1.1
Default gateway	X	X	Section 28.1.1
Static unicast routing	X	X	Section 28.1.4
Specifying source IP	X	X	Section 28.1.4.3
Blackhole routes		X	Section 28.1.4.4
Dynamic unicast routing			
- OSPF	X	X	Section 28.1.1, Chapter 29
- RIP (v1/v2)	X	X	Section 28.1.1, Chapter 30
Static multicast routing	X	X	Section 28.1.1, Chapter 31
View routing table	X	X	
Router redundancy (VRRP)	X	X	Section 28.1.1, Chapter 32
Firewall and NAT	X	X	Section 28.1.1, Chapter 33

Table 28.1: Summary of router and routing features.

The routing table can either be managed manually via *static IP routing*, or automatically by using dynamic routing protocols, or a combination of both. Static IP routing is usually fine for small IP networks, or networks with no redundant paths. To manage routing in larger networks, it is preferred to use *dynamic IP routing*. With dynamic routing, the routers will exchange routing information and build up their routing tables dynamically. Furthermore, dynamic routing utilises network redundancy; if a link goes down, routers will inform each other and packets will automatically be routed along another path. Thus, dynamic routing protocols perform a similar service in routed networks as FRNT ([chapter 16](#)) and RSTP ([chapter 18](#)) perform in switched networks. The time to react on a topology change is referred to as the *convergence time*. WeOS supports two dynamic routing protocols: Open Shortest Path First (OSPF) and Routing Information Protocol (RIP). OSPF is the recommended over RIP, due to its superior *convergence* characteristics.

OSPF and RIP are examples of unicast Interior Gateway Protocols (IGPs), which means they can be used to handle routing *within* a routing domain, such as an corporate network. This is also referred to as *intra-domain* routing, as opposed *inter-domain* routing, which is commonly handled using the Border Gateway Protocol (BGP)¹. OSPF and RIP are covered in [chapters 29](#) and [30](#) respectively.

¹As of WeOS v4.33.0, dynamic routing is limited to intra-domain (unicast) routing with RIP and OSPF. WeOS does *not* support dynamic inter-domain routing via BGP (Border Gateway Protocol), or dynamic multicast routing.

IP multicast routing enables efficient distribution of multicast data in a routed network. A *source*, such as an IP camera, will send its data to a specific multicast IP address (also referred to as a multicast group), and *receivers* (the group members) will listen in to this address by joining the group. WeOS supports static multicast routing, which enables the network manager to manually set the multicast routing entries in the routers. Dynamic multicast routing protocols, such as DVMRP or PIM-SM, are not yet supported. See [chapter 31](#) for more details on IP multicast routing.

While dynamic routing protocols such as RIP and OSPF enable routers to find redundant paths in case a link or router goes down, they do not enable end devices (hosts) to use a second router if their *regular* router goes down. To support redundancy between hosts and routers the Virtual Router Redundancy Protocol (VRRP) is used. With VRRP, a backup router will take over if a router fails, and communication from connected hosts can continue automatically. VRRP support is covered in [chapter 32](#).

When a router is used as a company gateway to a public network, such as the Internet, there is an obvious need to protect the local company network against network intrusion and other attacks. It is also common that the hosts and routers within the company network use *private* IP addresses. To protect the company network and to enable the use of private IP addresses, WeOS includes *firewall* and *network address translation* (NAT) support. [Chapter 33](#) describes the NAT and firewall features in WeOS.

Another need which occurs when connecting company networks to the Internet is to ensure communication privacy. WeOS supports IPsec VPN and SSL VPN (OpenVPN) to establish secure communication over public networks. With VPNs, a company can secure communication between a head office and different branch offices by installing a WeOS device as VPN gateway at each site. WeOS VPN support is covered in [part IV](#).

28.1.2 Using a WeOS device as a switch or as a router

WeOS devices are both able to route and to switch packets, i.e., they are *routing switches*. Switching is performed between ports in the same VLAN, while routing is performed between IP subnets or network interfaces (please see [fig. 22.1](#) in [section 22.2](#) for information on the distinction between ports, VLANs and network interfaces in WeOS). Routing can be disabled, and the WeOS device will then act as a VLAN capable *switch*.

28.1.3 Learning routing information from different sources

A WeOS device will learn about routing information by manual configuration (connected interfaces or static routes), dynamic address assignment (e.g., DHCP), or via dynamic routing protocols (OSPF and RIP). As described in [chapters 29 and 30](#), a router is able to redistribute external routing information into an OSPF or RIP routing domain.

In some situations a router will learn the route to the same destination through different mechanisms. In this case, the route to use will depend on the *administrative distance* (or simply "admin distance") associated with the involved routing mechanisms. A route with a lower admin distance will be prioritised over a route with higher admin distance.

Connected routes are always preferred (they have admin distance '0' (zero)). In WeOS the admin distance of static routes, and routes learnt dynamically via RIP and OSPF can be configured, but defaults to the values shown in the table below. Routes learnt dynamically via DHCP or PPP will have admin distance according to the distance assigned to the associated interface, see [section 22.2.6](#).

	Administrative Distance
Connected	0
Static	1
OSPF	110
RIP	120

Configuring static routes with higher administrative distance than set for OSPF or RIP is also referred to *floating static routes*, see [section 28.1.4.2](#) for further details.

28.1.4 Static routing

WeOS supports static IP routing. With static routing a WeOS device can specify the next hop router to use to reach a given IP subnet, or add additional (directly attached) subnets to a local interface.

28.1.4.1 Using Static Route with Next-Hop or Interface as target

When defining a static route, the target is typically an IP address, e.g., "**route 192.168.5.0/24 192.168.1.1**" where "**192.168.1.1**" would be the IP address of the next-hop router towards the destination.

In other situations you could define the target as a network interface of your unit, e.g., "**route 192.168.5.0/24 ssl0**" where all traffic towards "**192.168.5.0/24**" would be sent via your SSL VPN interface ([chapter 38](#)).



Note

Using an interface as target of a static route is almost only used on point-to-point interfaces, e.g., SSL or GRE interfaces. In rare cases it can be used on LAN interfaces when you have multiple subnets on a VLAN, but in those cases it is often simpler to use a secondary IP address on that LAN interface, see [section 22.2.5](#).

28.1.4.2 Floating Static Routes - Administrative Distance for Static Routes

Floating static routes are static routes with higher *administrative distance* (see [section 28.1.3](#)) than routes learnt dynamically, e.g., via routing protocols such as OSPF and RIP, or via dynamic configuration protocols such as DHCP or IPCP (PPP).

An example where a default route acquired via DHCP is given precedence over a floating static (default) route is given in [section 22.2.6](#). To complement this, an example where routes learnt via OSPF is given precedence over a floating static route is illustrated in [fig. 28.1](#).

In this example, the user could have used OSPF over the low-speed backup link, but has instead chosen to use a floating static route. Relevant parts of the configuration at routers 1, 2 and 3 are shown below.

Router 1 injects a default route into the OSPF area, and defines a floating static route towards *192.168.35.0/24* via Router2.



Example

```
#Router1
ip
    route 0.0.0.0/0 192.168.32.1
    route 192.168.35.0/24 192.168.33.2 200
end

router
    ospf
        network 192.168.34.0/24 area 0.0.0.0
        distribute-default always
    end
end
```

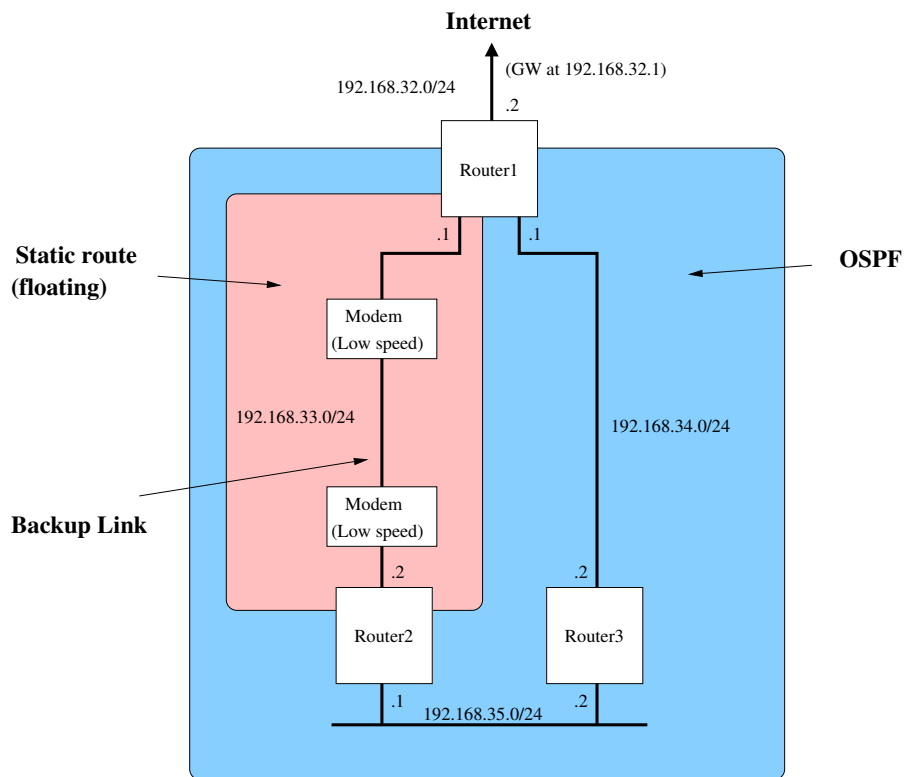



Figure 28.1: Use of floating static route for on low-speed backup link.

Router 2 defines a floating static default route towards via Router1, and injects a default route into the OSPF area *given* that its floating default route is active (no **"always"** attribute; compare with Router1 configuration).

Example

```
#Router2
ip
    route 0.0.0.0/0 192.168.33.1 200
end

router
    ospf
        network 192.168.35.0/24 area 0.0.0.0
        distribute-default
        end
end
```

Router 3 has no static routes, i.e., it only uses OSPF.

Example

```
#Router3
router
  ospf
    network 192.168.34.0/24 area 0.0.0.0
    network 192.168.35.0/24 area 0.0.0.0
  end
end
```

28.1.4.3 Specifying preferred source IP address

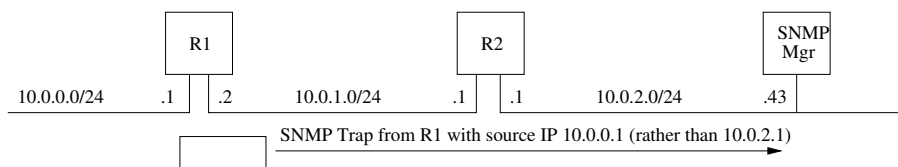

Figure 28.2: Use of 'preferred source address' to control which source IP to use when communicating with a destination network (here the host at 10.0.2.43).

When your WeOS unit is multihomed, you may want to control which source IP address it is using. In the example above, an SNMP Manager at 10.0.2.43 requires R1 to send traps with source IP 10.0.0.1 (perhaps due to firewall settings at the SNMP Manager). However, R1 is multihomed and may use address 10.0.1.2 instead. To ensure 10.0.0.1 is used, R1 can be configured with 10.0.0.1 as *preferred source IP address* when communicating with 10.0.2.43.

Example

```
#Router1
ip
  route 10.0.2.43/32 10.0.1.1 src 10.0.0.1
  route default 10.0.1.1
end
```

The specified source address must belong to the unit (R1 in the example above) for the route to become active.

28.1.4.4 Blackhole routes

WeOS has a *blackhole* interface referred to as "**null0**". This interface is hidden in the sense that it cannot be configured (no IP address, management settings,

etc.). The blackhole interface is useful to avoid routing loops in networks with incomplete subnetting.

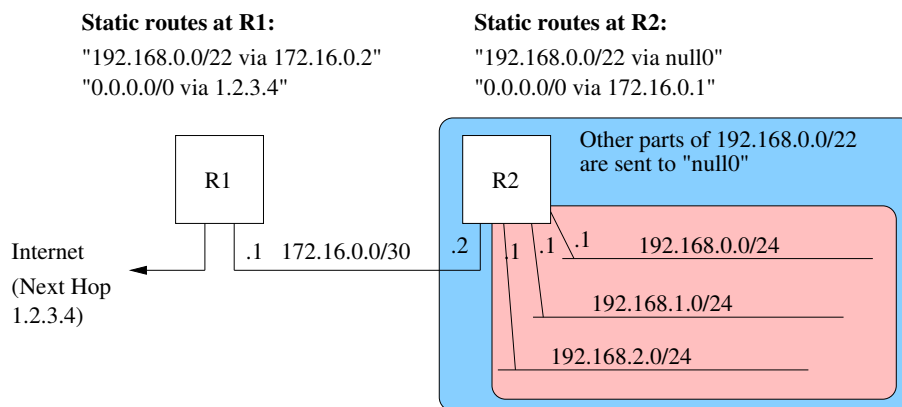

Figure 28.3: Use of blackhole route at router R2 to avoid a routing loop for addresses within range 192.168.2.0-192.168.255.255.

An example is shown in [fig. 28.3](#). R1 has set a static route for the "192.168.0.0/22" range towards R2. R2 only has routes to a part of this range, i.e., the directly connected subnets "192.168.0.0/24", "192.168.1.0/24" and "192.168.2.0/24", while "192.168.3.0/24" is currently unused. As R2 has defined R1 as its default route, a packet sent towards e.g., "192.168.3.11" would bounce back and forth between R1 and R2, unless R2 defines a blackhole route.

Note

In this example, the static blackhole route for "192.168.0.0/22" has a shorter prefix than the directly connected routes. Therefore only traffic in range "192.168.3.0/24" will be sent to "null0" as long as the interfaces to the directly connected subnets are up.

Use of blackhole routes is also useful when setting up SSL VPNs or IPsec VPNs. By use of blackhole routes, you can avoid that private traffic to the peer side is routed (unencrypted) towards the Internet when the VPN tunnel is down. See [section 38.1.6](#) for an example of using blackhole routes with SSL VPNs.

28.1.5 Limitations When Using RSTP and Routing

As of WeOS v4.33.0 a single RSTP instance per WeOS unit is supported. This works fine in a switched environment where all VLANs on a switch can be added

to inter-switch ports, see also [chapters 15 \(VLAN\)](#) and [18 \(RSTP/STP\)](#).

However, when using RSTP in a routed environment it is often needed to run a separate instance of RSTP per VLAN. Otherwise there is a risk that RSTP incorrectly detects a loop (at layer-2) and blocks some port, even though there is a "routing barrier", which already handles the loop. The result of RSTP blocking ports may be loss of connectivity at layer-3.

RSTP is typically enabled on all ports by default. When using the WeOS device as a router, it is therefore recommended either to

- disable RSTP as a whole, or
- disable RSTP on all ports but one VLAN, or a group of VLANs with a shared layer-2 backbone (such as a ring).

Support for multiple RSTP/STP instances is planned but not yet implemented.

28.2 View Unicast Routing Table and Manage Static Unicast Routes via Web Interface

Web configuration of static *unicast* routes is presented in [section 28.2.1](#), and examination of the current (unicast) routing table via Web is covered in [section 28.2.2](#).

Web configuration of static *multicast* routes and examination of the *multicast* routing table is instead handled in [chapter 31](#).

28.2.1 Managing Static Unicast Routing via Web Interface

Menu path: Configuration ⇒ Routing ⇒ Static Route

The main static routing configuration page lists the currently configured static routes.



Static Routes

Destination	Netmask	Distance	Gateway	Interface	Source IP	Description		
192.168.5.0	255.255.255.0	1	192.168.2.1	*				
192.168.10.0	255.255.255.0	1	192.168.3.1	*				
192.168.4.0	255.255.255.0	1	*	vlan2				
192.168.5.3	255.255.255.255	1	192.168.2.1	*	192.168.1.5			

[New](#)

Destination	The subnet to route towards
Netmask	The netmask defining the destination subnet
Distance	The administrative distance used when selecting between multiple routes to the same destination (floating static route).
Gateway	The destination next-hop router
Interface	The destination interface (directly attached subnet)

Continued on next page

Continued from previous page	
Source IP	(Optional) On a multihomed unit, specify preferred source IP address, see section 28.1.4.3 .
Description	Field indicating if this is the default route. The default route can be changed or removed using the Global Network Settings (check Section 22.5.1)
 Edit	Click this icon to edit a route.
 Delete	Click this icon to remove a route. You will be asked to acknowledge the removal before it is actually executed.

Menu path: Configuration ⇒ Routing ⇒ Static Route ⇒  **Edit**

The edit page, see table above for descriptions.

Static Routes - Edit

Destination	<input type="text" value="192.168.10.0"/>
Netmask	<input type="text" value="255.255.255.0"/>
Distance	<input type="text" value="1"/>
Next Hop	<input type="text" value="Gateway"/> <input type="text" value="192.168.3.1"/>
Source IP*	<input type="text"/>

**Optional, preferred source IP for multihomed unit*

28.2.2 Examine Routing Table via the Web Interface

Menu path: Status ⇒ Routing ⇒ Routes

On this page the current IP routes are listed.

Routes

```

S - Static | C - Connected | K - Kernel route | > - Selected route
O - OSPF   | R - RIP       | [Distance/Metric] | * - Active route

C>* 127.0.0.0/8 is directly connected, lo
K>* 192.168.0.0/23 via 198.18.131.99, vlan1, src 20.0.0.1
K>* 192.168.1.0/24 via 198.18.131.99, vlan1, src 20.0.0.1
S   192.168.3.0/24 [8/0] via 192.168.1.1 inactive
S   192.168.3.0/24 [1/0] is directly connected, vlan2 inactive
C>* 198.18.131.0/24 is directly connected, vlan1
    
```

Auto-Refresh: Off, 5s, 15s, 30s, 60s

One or more codes describe which source the route has, and if it is selected.

C	Connected - A network is known by a direct connection to the switch.
K	Kernel route
S	Static - A statically configured route.
R	RIP - The route is known through the RIP protocol.
O	OSPF - The route is known through the OSPF protocol.
>	Selected route
*	FIB route

28.3 Enabling Routing, Managing Static Routing, etc., via CLI

The table below shows WeOS CLI commands relevant for handling static routing. The detailed description of these commands is found in other chapters as listed in the table.

Dynamic routing (RIP and OSPF) and other router related protocols (VRRP) share a common *router* configuration context which is also listed in the table.

Command	Default	Section
<u>Configure general routing settings</u>		
ip		Section 22.7.1
[no] default-gateway <IPADDR>	DEPRECATED	Section 22.7.2
[no] route <SUBNET NETMASK NETWORK/LEN> <GATEWAY IFACE> [DISTANCE] [src ADDRESS]	Distance 1	Section 22.7.3
[no] forwarding	Enabled	Section 22.7.4
router		Section 28.3.1
[no] ospf		Section 29.3
[no] rip		Section 30.3
[no] vrrp <ID>		Section 32.3
<u>Show general routing status</u>		
show ip route		Section 22.7.26

28.3.1 Manage Router Protocols

Syntax router

Context [Global Configuration](#) context

Usage Enter the Router Protocol Configuration context. From here you can configure dynamic routing protocols such as OSPF ([section 29.3](#)) and RIP ([section 30.3](#)) and, as well as other router related protocols such as VRRP ([section 32.3](#)).

Use "**show router**" to list general router protocol settings (also available "**show**" command within the Router Protocol Configuration context).

Default values N/A

Example

```
Example  
example:/config/#> router  
example:/config/router/#> show  
OSPF/RIP not enabled.  
VRRP Instances =====  
ID   Interface  Router-ID  Priority  Address  
=====
```

ID	Interface	Router-ID	Priority	Address
1	vlan1	1	100	192.168.2.1

```
example:/config/router/#>
```

Chapter 29

Dynamic Routing with OSPF

This chapter describes WeOS support for the OSPF dynamic routing protocol.

29.1 Overview of OSPF features

Feature	Web	CLI	General Description
<u>General OSPF settings</u>			
Router-id	X	X	Section 29.1.1.1
OSPF Networks	X	X	Section 29.1.1.1
Area type (regular, stub, NSSA)	X	X	Sections 29.1.1.2 , and 29.1.1.4-29.1.1.5
Redistribution (static, connected, RIP)	X	X	Section 29.1.1.3
Distribute default route	X	X	Section 29.1.1.3
Inter-area summarisation	X	X	Section 29.1.1.6
Inter-area filtering	X	X	Section 29.1.1.6
(Explicit) neighbour	X	X	Section 29.1.1.7
Passive interface default	X	X	Section 29.1.1.8
<u>Per interface OSPF settings</u>			
Link cost	X	X	Section 29.1.1
Network type	X	X	Section 29.1.1.7
Passive interface	X	X	Section 29.1.1.8
Authentication (MD5, plain)	X	X	Section 29.1.1.9

Continued on next page

Continued from previous page

Feature	Web	CLI	General Description
Hello/Dead intervals	X	X	Section 29.1.1.10
Designated Router priority	X	X	Section 29.1.1.11



Note

As of WeOS v4.33.0 there is no support for "load balancing" in case there are multiple paths with equal cost to reach a destination.

When an OSPF configuration change is done in WeOS, OSPF will be restarted on that router. Until the OSPF routing protocol has converged, this may cause a temporary loss of connectivity in parts of your network.

29.1.1 OSPF introduction

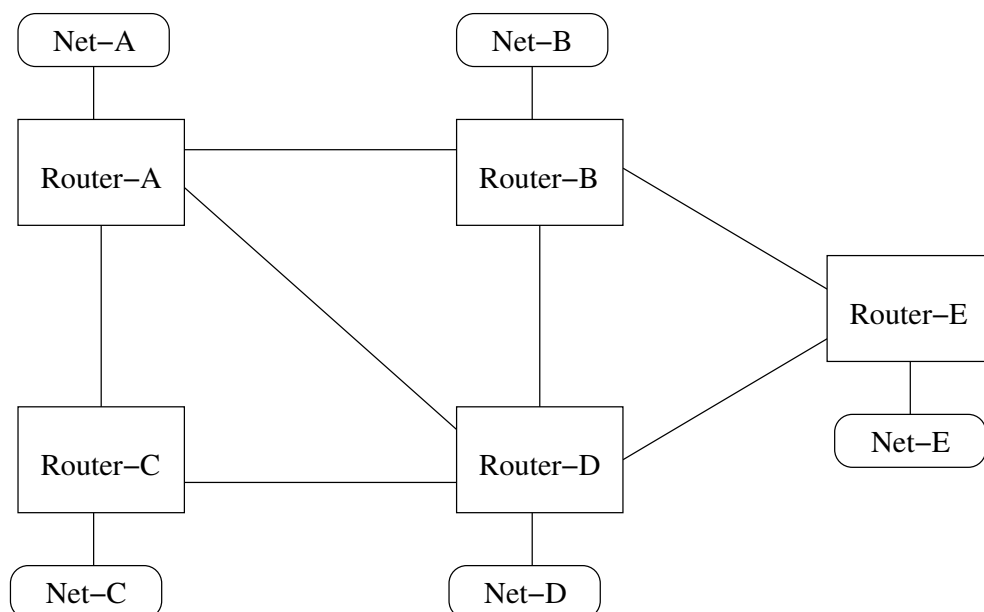

Figure 29.1: Simple network topology with interconnected routers and networks.

Dynamic routing protocols such as OSPF and RIP ([chapter 30](#)) simplifies router configuration, and improves network robustness.

- *Simplified configuration:* Manual configuration of static routes is not needed, and thereby a time consuming and error-prone procedure is avoided. In the network shown in [fig. 29.1](#), each router would only have to be configured with information about its own identity and the IP subnets it is attached to. Routers will then exchange this information, and be able to establish the appropriate routing table by themselves.
- *Improved robustness:* If the topology changes, perhaps because a link failed, routers will automatically detect this and inform each other. The data traffic will be forwarded other ways, given that a redundant path to the destination exists.

OSPF is an example of a *link-state* routing protocol. In a link-state routing protocol, each router announces information about its own identity (*router-id*), its directly connected networks, and its neighbour routers. This information is *flooded* throughout the OSPF domain, and each router will store the information in a local OSPF database. Each router will gain complete knowledge about every router and link in the whole topology, and is therefore able to compute the best path (the least cost path) to reach every destination¹.

For example, Router-A in [fig. 29.1](#) would send out OSPF messages informing other routers about its *router-id*, its connected networks, i.e., Net-A and the links towards routers A, B, and C, the identity of (and link to) its neighbour routers (A, B and C).

A major advantage of link-state routing protocols, such as OSPF, over distance vector routing protocols, such as RIP, is the *fast convergence* after a topology change. If a link goes down, information about this can be flooded rapidly to all routers within the routing domain, and each router can then update their routing table accordingly.

29.1.1.1 OSPF Router-ID and OSPF Networks

We use the example below to explain some essential OSPF parameter settings (the example is for *Router-A* in [fig. 29.2](#)).

 **Example**

```
router
  ospf
    router-id 10.0.11.1
```

¹In OSPF, a cost is associated with every link. As of WeOS v4.33.0, the default cost per link is "10". The link cost can be configured per interface, see [section 29.3.16](#) for details.

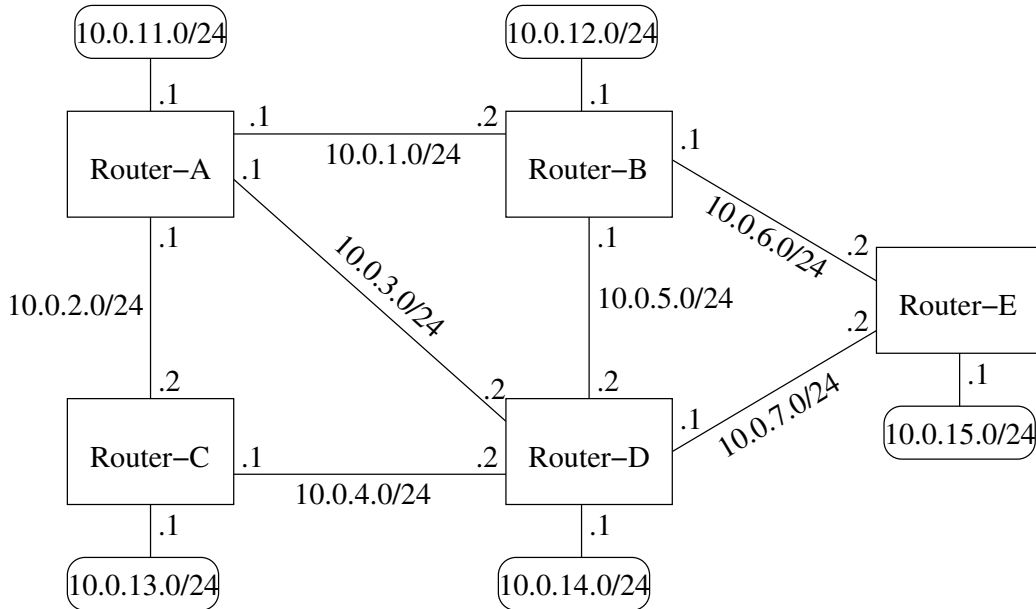

Figure 29.2: Example OSPF network with IP addresses and subnets.

```

network 10.0.1.0/24 area 0.0.0.0
network 10.0.2.0/24 area 0.0.0.0
network 10.0.3.0/24 area 0.0.0.0
network 10.0.11.0/24 area 0.0.0.0
end

```

The **"router-id"** line states the identity of this OSPF router, and must be unique within this OSPF routing domain.

- The router-id is 32-bit value, and can be specified either as a regular integer value, or in *dotted-decimal* form, just like an IP address.
- It is *common practise* to set the *router-id* to one of the IP addresses assigned to the router.
- If no router-id is configured, WeOS will pick one of the router's configured IP addresses, and use that as router-id.

As mentioned in [section 29.1.1](#), the router should inform the other routers about its attached links and networks. However, a router will announce its networks and links first when they are declared to be within the OSPF routing domain – this is done via the **"network"** command. Furthermore, a **"network"** declaration

implies that OSPF messages will be exchanged through the corresponding network interface. (In some network setups one likes to include a subnet within the OSPF domain, without activating OSPF on the corresponding interface. This can be achieved by configured that interface as *passive*, see [section 29.1.1.8](#).)

In the example above, Router-A has been configured to include and announce all its subnets in the OSPF domain (10.0.1.0/24, 10.0.2.0/24, etc.). From the example we can also see that the **"network"** declaration contains an *area* parameter. OSPF areas are further explained in [section 29.1.1.2](#).

29.1.1.2 OSPF hierarchy and areas

Being a link state protocol, OSPF requires routers to keep a lot of routing information in their database:

- Each OSPF router will typically keep a database with information of every router and link in the whole OSPF domain.
- OSPF routers will also redistribute and keep routing information learnt from external sources (static routes, routes learnt via other routing protocols, etc.).

To reduce the burden of keeping keeping state information about the whole OSPF domain, the domain can be split into OSPF *areas*. (For information on how to avoid the need to keep information on external routing information, see [section 29.1.1.4](#).)

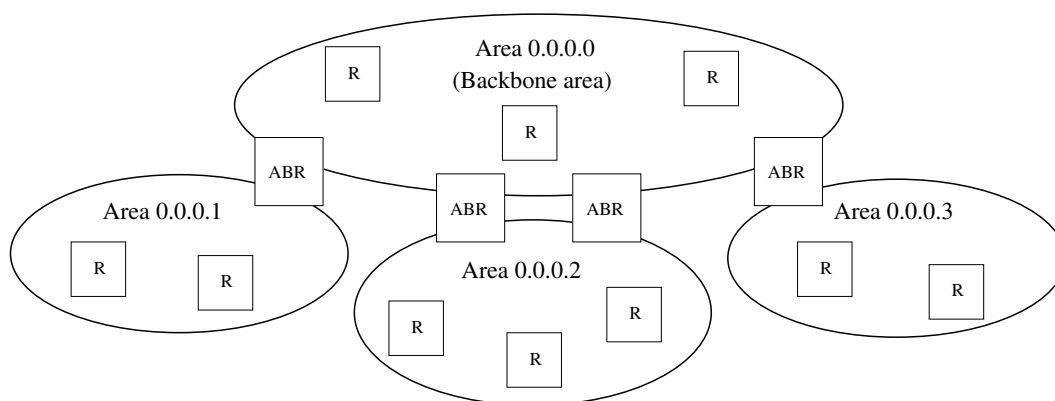

Figure 29.3: Sample OSPF hierarchy with a backbone area and three other areas.

The routers in [fig. 29.3](#) have been divided into four areas. When splitting the network into multiple areas, each router will only have full knowledge of the

topology within their respective area. Routers will also keep *summary* information about destinations outside their own area, but routers will not have knowledge about the actual topology inside other areas.

Each IP subnet can only be part of one OSPF area, and when configuring OSPF networks you should also define which area it belongs to. The area identifier is a 32 bit value, which can be stated as a decimal value, but is commonly written in *dotted decimal form*. E.g., "**network 10.0.1.0/24 area 0.0.0.0**" is equivalent to writing "**network 10.0.1.0/24 area 0**".

A router which have networks in different areas is called an *area border router* (ABR). An example is given below.

```
Example
router
  ospf
    router-id 192.168.5.11
    network 192.168.5.0/24 area 0.0.0.0
    network 192.168.11.0/24 area 0.0.0.1
  end
```

In OSPF, areas are organised in a two-level hierarchy. At the top we have *area 0*, which is referred to as the *backbone area*. As the hierarchy is limited to two levels, every ABR must be connected to the backbone area. Direct connections between areas at lower level is prohibited; all inter-area traffic should go via the backbone area².

To allow for a more flexible area hierarchy, OSPF provides a feature referred to as *virtual links*, however, OSPF virtual links are not supported in WeOS v4.33.0.

29.1.1.3 Route redistribution and default route

Route information learnt from other routing protocols (RIP, BGP³, etc.) *can* be redistributed (i.e., imported) into the OSPF domain. The same goes for static routes, and directly connected networks.

To let a router redistribute routing information into the OSPF domain, the "**redistribute**" command is used, e.g., "**redistribute rip**" to import routes learnt via RIP. An OSPF router performing route distribution into the OSPF domain is referred to as an administrative system border router (ASBR).

²The reason for introducing these topology limitations is to avoid the "counting to infinity" seen in *distance vector* protocols (see [chapter 30](#)) problem to occur for OSPF inter-area routing.)

³As of WeOS v4.33.0 BGP is not supported.

Routers can inject a default route (0.0.0.0/0) into the OSPF domain. This is done using the "**distribute-default [always]**" command. Without the "**always**" keyword, the router will only inject the default route if it itself has a default route.

External routes can be added at two levels, *type 1* and *type 2* external routes:

- *Type 1*: Type 1 external routes are typically used when importing routes, that are locally managed, e.g., a static routes inside your domain, or from a local RIP domain.

The ASBR located in area 0.0.0.2 in [fig. 29.4](#) would preferably redistribute the routes learnt via RIP as *type 1* external routes.

- *Type 2*: Type 2 external routes are typically used when importing routes managed by another operator, e.g., routes learnt via BGP.

The ASBRs located in area 0.0.0.0 in [fig. 29.4](#) would preferably redistribute the routes learnt via BGP as *type 2* external routes.

29.1.1.4 Stub areas and totally stubby areas

In some situations one wish to limit the routing information going into an area to be limited even further, perhaps due to limited resources on the router. For this situation, OSPF provides a special area type referred to as a *stub area*.

As with other OSPF routers, routers inside a stub area will have full routing information for networks and routers within their own area and summary routes to destinations in other areas, *but* need not keep routing information learnt from *external* sources (static routes, or routes learnt via other routing protocols such as RIP, BGP, etc.). In a stub area, routing to networks outside the OSPF domain is instead based on *default routing* towards the ABR(s); i.e., the ABR will filter out all external routing information and instead inject a default route (pointing to itself) area.

To create a *stub* area, **all routers** in the area (ABRs as well as internal routers) must declare the area as stub. An example is given below.

Example

```
router
  ospf
    router-id 192.168.5.11
    network 192.168.5.0/24 area 0.0.0.0
    network 192.168.11.0/24 area 0.0.0.1
    area 0.0.0.1
      stub
```



```
end
end
```

To reduce the routing information going into a stub area even further, it is possible to prohibit *summary* routes from other areas to go into a stub area. This is done by adding the *no-summary* parameter to the stub command ("**stub no-summary**"); this is only needed on the ABR(s) of the stub area.

Such areas are referred to as *totally stubby* areas.

The cost of the default route being injected into the stub area is by default set to "1". The cost value can be configured via the "**default-cost**" command within the area context.

The backbone area cannot be configured as a stub area.

29.1.1.5 Not so stubby areas (NSSAs)

In a stub area, no router can redistribute routing information learnt from external sources (static routes, BGP, etc.). That is, a stub area cannot contain an *autonomous system border router* (ASBR).

If you wish to have an ASBR in an area, but limit the amount of routing information to keep track of as in a stub area, OSPF provides an area type known as *not so stubby area* (NSSA).

Fig. 29.4 demonstrates a case where NSSAs can be a useful choice. Here we assume that area 0.0.0.1 and area 0.0.0.2 are preferably defined as *stub areas* to avoid that BGP routes (redistributed by the ASBRs in the backbone area) are propagated into those areas. But area 0.0.0.2 includes a router connected to a local RIP network. By defining area 0.0.0.2 as a NSSA, the RIP routes can be redistributed into the OSPF network.

NSSA are created in the same way as a *stub area* (see [section 29.1.1.4](#)). **All routers** in the area must declare the area as NSSA. An example is given below.

Example

```
router
  ospf
    router-id 192.168.5.12
    network 192.168.5.0/24 area 0.0.0.0
    network 192.168.16.0/24 area 0.0.0.2
    area 0.0.0.2
      nssa
```

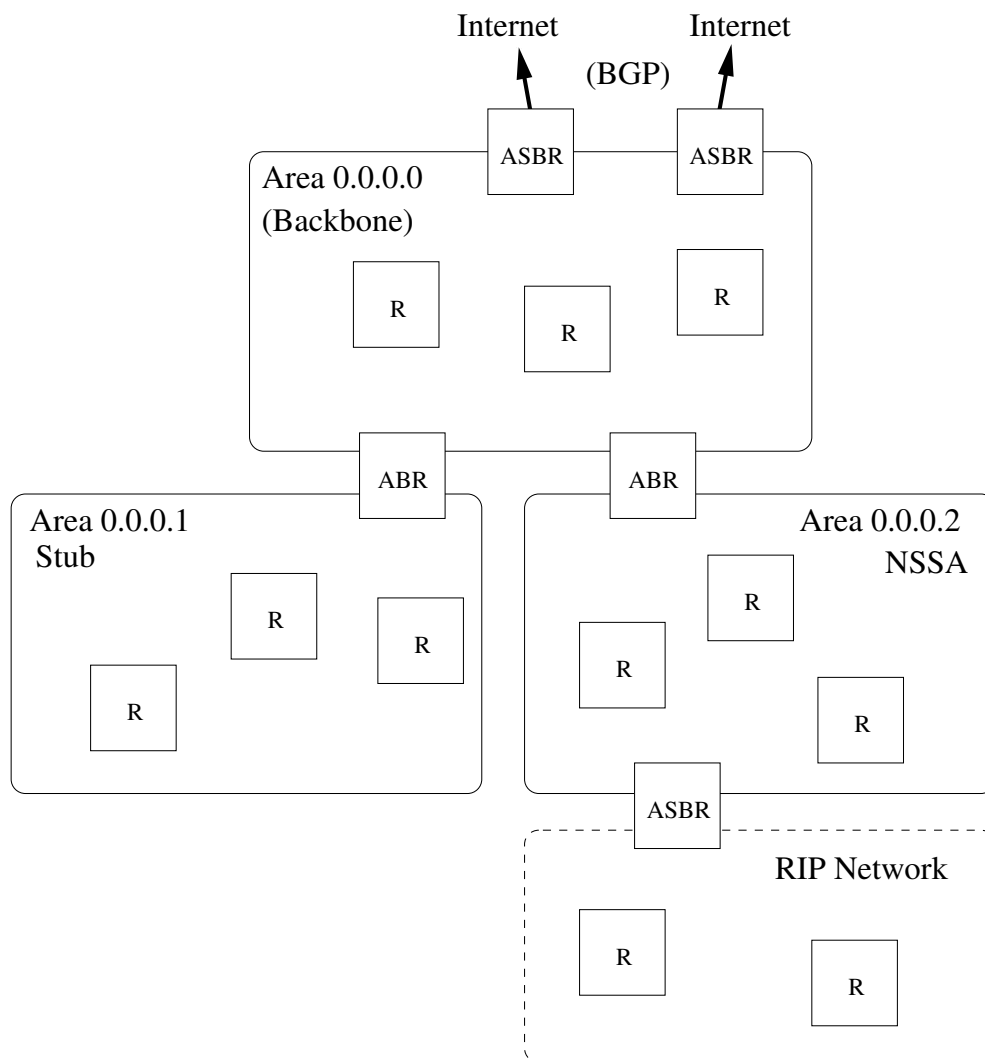

Figure 29.4: Topology where NSSA areas are useful.

```

end
end
    
```

As with stub areas, NSSAs are able to prohibit inter-area routing information to be distributed inside the area (use **"nssa no-summary"** on the ABRs of the area). Such areas are called *NSSA totally stub areas*.

The backbone area cannot be configured as a NSSA area.

29.1.1.6 Additional Area Specific Settings

ABRs are able to filter and to aggregate routing information before distributing it into another area. This is managed using the "**range <NETWORK/LEN> [not-advertise]**" command.

- *Route filtering:* With the "**not-advertise**" keyword, any route matching the given range will be filtered out when distributing routing information outside a certain area.
- *Route summarisation:* Without the "**not-advertise**" keyword, all routes matching the given range will be summarised (aggregated) as a single destination (of given network and prefix length) outside of a certain area.

Below is an example where an ABR will filter out routes in *192.168.16.0/20* when distributing routes from *area 0.0.0.2*. Similarly, all routes inside *area 0.0.0.2* matching *172.16.0.0/16* will be summarised to single route, when distributing routes from *area 0.0.0.2*.

 **Example**

```
router
  ospf
    router-id 192.168.5.12
    network 192.168.5.0/24 area 0.0.0.0
    network 192.168.16.0/24 area 0.0.0.2
    network 192.168.19.0/24 area 0.0.0.2
    area 0.0.0.2
      range 192.168.16.0/20 not-advertise
      range 172.16.0.0/16
    end
  end
end
```

29.1.1.7 Network Types - Broadcast and Non-Broadcast

OSPF can be used on *broadcast* and *non-broadcast multiple access* (NBMA) links. The default is *broadcast*, enabling OSPF routers to discover each other without further configuration; when OSPF is enabled on a network, routers exchange OSPF *Hello* messages via multicast to OSPF's well-known IP address 224.0.0.5.

In the rare cases where multicast cannot be used for OSPF Hello exchange, use of the *non-broadcast* mode may be used, but then IP address of the OSPF neighbour router(s) needs to be explicitly configured. For example, consider an OSPF router with IP address 10.0.16.1/24 having neighbour with IP address 10.0.16.2

connected on a network not capable of signalling via multicast. Then the following configuration could be used (together with a corresponding setup on the neighbour router).

Example

```
iface vlan100 inet static
    ...
    ... Skipping lines
    ...
    address 10.0.16.1/24
    ospf
        network non-broadcast
    end
router
    ospf
        neighbor 10.0.16.2
        network 10.0.16.0/24 area 0.0.0.0
    end
end
```

29.1.1.8 Passive Interfaces

In some situations you may wish to include a router's subnets as part of the OSPF routing domain without running OSPF on the associated network interface. To accomplish this the *network* should be defined in the *router ospf* context (as usual), and the related interface should be declared as *passive* in the *interface ospf* context. Below is an example where network *192.168.33.0/24* should be included in the OSPF domain, but where the associated interface (*vlan100*) is declared as passive.

Example

```
iface vlan100 inet static
    ...
    ... Skipping lines
    ...
    address 192.168.33.1/24
    ospf
        passive
    end
router
    ospf
        router-id 192.168.15.1
        network 192.168.15.0/24 area 0.0.0.0
        network 192.168.33.0/24 area 0.0.0.0
    end
```

```

end
end

```

By default, OSPF will run on all interfaces which have an associated network declared as an OSPF network. If OSPF should *not* run on such an interface, that interface should be declared as passive, as described above. However, WeOS is able to support use cases where the interfaces should be passive by default. The parameters controlling the behaviour are the "**passive-interface**" setting in *router ospf* context, and the "**passive**" setting in the *interface ospf* context.

- *passive-interface*: Use the "**[no] passive-interface**" setting in *router ospf* context to control whether interfaces should be passive in OSPF by default or not. Default setting: Active ("**no passive-interface**")
- *passive*: Use the "**[no] passive [auto]**" setting in *interface ospf* context to control whether a specific interface should be passive ("**passive**"), active ("**no passive**"), or to automatically follow ("**passive auto**") the global OSPF setting declared by the "**[no] passive-interface**" setting in *router ospf* context. Default: Auto ("**passive auto**")

Below is an example, with the same result as above, where interfaces are passive in OSPF by default.

Example

```

iface vlan110 inet static
    ...
    ... Skipping lines
    ...
    address 192.168.15.1/24
    ospf
        no passive
    end
end

router
    ospf
        router-id 192.168.15.1
        passive-interface
        network 192.168.15.0/24 area 0.0.0.0
        network 192.168.33.0/24 area 0.0.0.0
    end
end

```

29.1.1.9 OSPF security

If an "external" OSPF router happens to connect to your network (maliciously or by mistake) the routing inside your domain can be affected severely. E.g., if that router injects a default route into the OSPF domain, all traffic supposed to go to your Internet gateway may instead be routed towards this "foreign" router.

To avoid that this happens, it is good practise to enable authentication of all OSPF messages inside your network. WeOS provides two forms of authentication of OSPF messages:

- *Plain*: Plain text authentication will protect against the situation when careless users attach an OSPF router to your network *by mistake*. However, since the password is sent in plain text inside the OSPF messages, it does not prohibit a deliberate attacker to inject routing information into your network. Plain text secrets are text strings of 4-8 characters.
- *MD5*: With MD5 authentication each OSPF message will include a cryptographic checksum, i.e., message authentication code (MAC), based on a secret only known by the system administrator. MD5 secrets are text strings of 4-16 characters.

Authentication of OSPF messages is configured per network interface, and is disabled by default.

Use of MD5 authentication is recommended. When using MD5 authentication, an associated *key identifier* must be specified. The purpose of the *key identifier* is to enable use of multiple MD5 keys in parallel when performing *key roll-over*. However, as of WeOS version v4.33.0 only a single OSPF secret per interface is supported.



Warning

Configuring OSPF authentication remotely in an operational network can be dangerous, since the communication towards that router can be broken if the neighbour routers do not yet have the corresponding authentication configuration. In this case it is good practice to always have a redundant routing path to the router you are configuring.

If the you end up in the situation where you can no longer reach a router due to a change in OSPF authentication configuration, you may be able to solve the situation by first logging into a "neighbour" of the "unreachable router", and from that router use SSH (see [section 7.3.38](#)) to login to the "unreachable router", and then update the configuration appropriately.

29.1.1.10 Finding OSPF Neighbours

OSPF routers will periodically transmit OSPF *Hello* messages, and routers can thereby discover new neighbour routers, and also detect if a neighbour router is down. There are two parameter settings related to the OSPF hello messages. These settings are configured per interface.

- *Hello-interval*: The interval (in seconds) at which this router is transmitting Hello messages. Default: 10 seconds
- *Dead-interval*: The interval (in seconds) after which a neighbour router is considered down if no Hello message from that router is received⁴. Default: 40 seconds



Note

All routers attached to a link must have identical "hello-interval" and "dead-interval" settings. That is, an OSPF router will only accept incoming Hello messages with identical hello and dead interval values as the router itself is using on that interface.

In the rare cases where the regular multicast exchange of Hello messages cannot be used, it is possible to explicitly configure the OSPF neighbours, see [section 29.1.1.7](#).

29.1.1.11 Designated OSPF router

In shared networks, such as Ethernets, there may be several routers attached to the same LAN. Representing a LAN as a full mesh of links between the attached routers may grow the OSPF database substantially if the number routers is large. Instead, link state protocols, such as OSPF, treats a shared link as a logical star, with a *virtual node* in the middle representing the shared network, see [29.5](#). The router which takes the role of network is referred to as the *designated router*.

The designated router (DR), as well as a backup designated router (BDR), are elected automatically. If no node has been elected as DR or BDR, the router with the highest configured DR election *priority* becomes the DR, using the *router-id* as tie-breaker when more than one router has highest priority.

⁴If the interface towards that neighbour goes down (e.g., if (all) the Ethernet port(s) associated with that interface goes down), the router will react immediately instead of waiting for the *dead-interval* to expire.

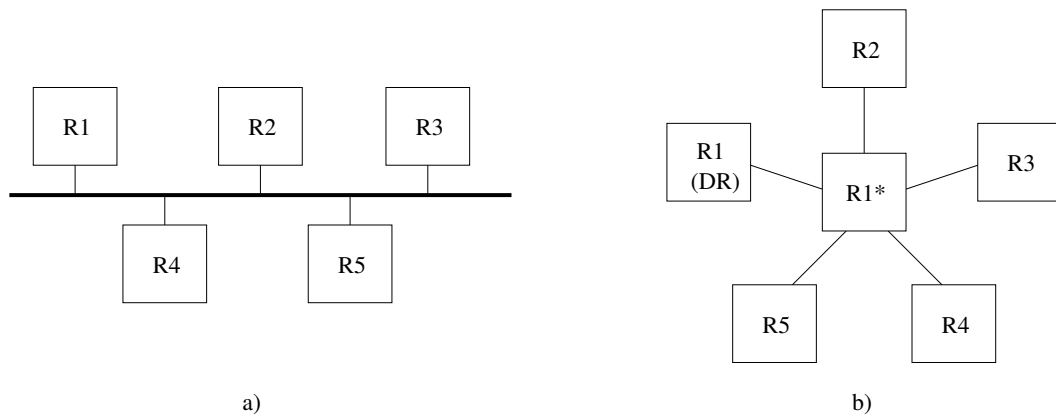

Figure 29.5: Link state protocols such as OSPF logically represent a shared link (a) as a star (b). One of the attached routers (here R1), will take the role as *designated router* and represent the "network" in the middle.

OSPF implements a *sticky* DR election scheme. Once a router has become DR, it will keep that role even when a router with higher DR priority comes up. However, a DR will give up its role if it discovers another router, which also consider itself to be DR, *and* if that router has higher priority (with router-id as tie). Such a situation could occur if a segmented LAN becomes connected.







29.2 OSPF Web

The Web interface provides configuration of OSPF.

Menu path: Configuration ⇒ Routing ⇒ OSPF



OSPF - Open Shortest Path First

Enabled













Router ID	Auto 	
OSPF Networks	Network	Area
	10.0.1.0/24	0.0.0.0  
	10.0.2.0/24	0.0.0.0  
	10.0.3.0/24	0.0.0.0  
	<input type="button" value="Add"/>	

Show Advanced View ▾



When entering the OSPF configuration page the basic settings are presented.

Router ID	Click on the  icon to set the OSPF router identifier. The router ID is given in a dotted decimal form <a.b.c.d> or as an integer
OSPF Networks	Enable OSPF on the router interface with the specified IP subnet (NETWORK/LEN). Click on the  to edit settings or the  icon to delete an entry. Press the Add button to add an entry.





To view all settings, click on **Show Advanced View** (see next page).

Router ID	Auto 			
OSPF Networks	Network	Area		
	10.0.2.0/24	0.0.0.0	 	
	10.0.3.0/24	0.0.0.0	 	
	10.0.1.0/24	0.0.0.0	 	
	<input type="button" value="Add"/>			
Interfaces Default Passive	No 			
Distribute	Default Route	Enabled	Metric	Type
		No	1	2 
Redistribute	Connected	Enabled	Metric	Type
	Static	No	1	2 
	RIP	No	1	2
Neighbor(s)	<input type="button" value="Add"/>			
Area Specific Settings	Area	Type	Default Cost	Route Summarization
	0.0.0.1	Regular	1	64.64.64.0/32 Advertise  
	<input type="button" value="Add"/>			
Protocol Distance	110 			

Interface Settings

Interface	Passive	Cost	Hello Interval	Dead Interval	Priority	Network Type	Authentication
vlan1	Auto	10	10	40	1	Broadcast	None 
vlan2	Auto	10	10	40	1	Broadcast	None 

Router ID	Click on the  icon to set the OSPF router identifier. The router ID is given in a dotted decimal form <a.b.c.d> or as an integer
Continued on next page	

Continued from previous page	
OSPF Networks	Enable OSPF on the router interface with the specified IP subnet (NETWORK/LEN). Click on the  to edit settings or the  icon to delete an entry. Press the Add button to add an entry.
Interfaces Default Passive	Define whether OSPF should be run on the interfaces defined (implicitly) via the OSPF network settings.
Distribute Default Route	Enable/disabled injection of a default route into the OSPF domain
Redistribute	Enable/disabled import of external routing information into the OSPF domain
Neighbor(s)	Setup OSPF neighbor routers explicitly
Area Specific Settings	Add specific settings to an area. Click on the  to edit settings or the  icon to delete an entry. Press the Add button to add an entry.
Protocol Distance	The administrative distance used when selecting between multiple routes to the same destination.

29.2.1 OSPF Status Page

Menu path: Status ⇒ Routing ⇒ OSPF

OSPF Status

[Overview](#) [Border-Routers](#) [Database](#) [Interface](#) [Neighbor](#) [Route](#)

```
OSPF Routing Process, Router ID: 192.168.2.230
Supports only single TOS (TOS0) routes
This implementation conforms to RFC2328
RFC1583Compatibility flag is disabled
OpaqueCapability flag is disabled
Initial SPF scheduling delay 200 millisecond(s)
Minimum hold time between consecutive SPFs 1000 millisecond(s)
Maximum hold time between consecutive SPFs 10000 millisecond(s)
Hold time multiplier is currently 1
SPF algorithm has not been run
SPF timer is inactive
Refresh timer 10 secs
Number of external LSA 0. Checksum Sum 0x00000000
Number of opaque AS LSA 0. Checksum Sum 0x00000000
Number of areas attached to this router: 0
```

Auto-Refresh: Off, [5s](#), [15s](#), [30s](#), [60s](#)

Refresh

Show the status of OSPF.

29.3 Managing OSPF via the CLI

The table below shows OSPF management features available via the CLI.

Command	Default	Section
<u>Configure General OSPF Settings</u>		
router		Sec. 28.3.1
[no] ospf	Disabled	Sec. 29.3.1
[no] router-id <ROUTERID>	Auto	Sec. 29.3.2
[no] network <NETWORK/LEN> [area <AREAID>]	area 0	Sec. 29.3.3
[no] neighbor <ADDRESSLIST>	Disabled	Sec. 29.3.4
[no] passive-interface	Active	Sec. 29.3.5
[no] distribute-default [always] [metric-type <1 2>] [metric <0-16777214>]	Disabled	Sec. 29.3.6
[no] redistribute connected [metric-type <1 2>] [metric <0-16777214>]	Disabled	Sec. 29.3.7
[no] redistribute static [metric-type <1 2>] [metric <0-16777214>]	Disabled	Sec. 29.3.7
[no] redistribute rip [metric-type <1 2>] [metric <0-16777214>]	Disabled	Sec. 29.3.7
[no] distance <1-255>	110	Sec. 29.3.8
[no] area <AREAID> [no] stub [no-summary]	Disabled	Sec. 29.3.9 Sec. 29.3.10
[no] nssa [no-summary]	Disabled	Sec. 29.3.11
[no] default-cost <0-16777215>	1	Sec. 29.3.12
[no] range <NETWORK/LEN> [<advertise not-advertise>]	advertise	Sec. 29.3.13
<u>Configure Interface Specific OSPF Settings</u>		
interface <IFACE>		
[no] ospf		Sec. 29.3.14
[no] passive [auto]	Auto	Sec. 29.3.15
[no] cost <1-65535>	10	Sec. 29.3.16
[no] hello-interval <1-65535>	10	Sec. 29.3.17
		Continued on next page

Continued from previous page

Command	Default	Section
[no] dead-interval <1-65535>	40	Sec. 29.3.18
[no] network <broadcast non-broadcast>	Broadcast	Sec. 29.3.19
[no] auth <md5 [KEYID] plain> <SECRET>	Disabled	Sec. 29.3.20
[no] priority <0-255>	1	Sec. 29.3.21
<u>View OSPF Status</u>		
show ip ospf		Sec. 29.3.22
show ip ospf route		Sec. 29.3.23
show ip ospf neighbor [<IFACE detail>]		Sec. 29.3.24
show ip ospf database [asbr-summary external network router summary>		Sec. 29.3.25
show ip ospf database max-age		Sec. 29.3.25
show ip ospf database self-originate		Sec. 29.3.25

29.3.1 Activate OSPF and Manage General OSPF Settings

Syntax [no] ospf

Context [Router Protocol Configuration](#) context

Usage Enter the Router OSPF Configuration context, and *activate* OSPF with default settings if OSPF is not activated already. Instead of running **"ospf"** from the [Router Protocol Configuration](#) context, you can use **"router ospf"** directly from the [Global Configuration](#) context.

Use **"no ospf"** to disable OSPF and delete all existing OSPF configuration.

Use **"show ospf"** to show a summary of all general OSPF settings. Also available as **"show"** command within the Router OSPF Configuration context.

Default values Disabled (no ospf)

29.3.2 Configure OSPF Router-ID

Syntax [no] router-id <ROUTER-ID>

Context [Router OSPF Configuration](#) context

Usage Set the OSPF router identifier, which must be unique within your OSPF domain. The router ID is a 32-bit value, and is given in a dotted decimal form <a.b.c.d> (where a-d are numbers in the range 0-255), or as an integer ($0..2^{32} - 1$). Commonly the router ID is set equal to one of the router's IP addresses.

In *Auto* mode, the router ID is *automatically* set to the IP address of one of the router's interface (the highest IP address), and stick to that value until the OSPF process is restarted.

Use **"show router-id"** to show the router-ID setting.

Default values Auto (no router-id)

29.3.3 Enable OSPF on an Interface

Syntax [no] network <NETWORK/LEN> [area <AREAID>]

Context Router OSPF Configuration context

Usage Enable OSPF on the router interface with the specified IP subnet (NETWORK/LEN), include that IP subnet in the OSPF routing domain, and determine the associated OSPF area.

The area ID is a 32-bit number, and is entered in dotted decimal form, or as an integer ($0..2^{32} - 1$). By default, the backbone area (0.0.0.0) is assumed.

Use **"no network <NETWORK/LEN> [area <AREAID>]"** to delete a configured **"network"** entry.

Use **"show network"** to show the OSPF network settings.

Default values Disabled, i.e., no **"network"** entries exist when first activating OSPF (see [section 29.3.2](#)). The backbone area (0.0.0.0) is used as default area.

29.3.4 Configure Static Neighbour Router

Syntax [no] neighbor <ADDRESSLIST>

Context Router OSPF Configuration context

Usage Manually configure OSPF neighbours. This may be useful when intermediate switches do not propagate IP multicast, or when using OSPF in NBMA (non-broadcast multiple access) networks.

Note

The **"neighbor"** setting is only applicable for interfaces configured as **"network non-broadcast"** (section 29.3.19).

Use **"neighbor <IPADDR>"** to manually add one (or more) OSPF neighbour router(s). Use **"no neighbor"** to remove all manually configured neighbours, or **"no neighbor <IPADDR>"** to remove a specific neighbour.

Use **"show neighbor"** to show manually configured OSPF neighbours.

29.3.5 Configure Interface Default Active/Passive Setting

Syntax [no] passive-interface

Context Router OSPF Configuration context

Usage Define whether OSPF should be run on the interfaces defined (implicitly) via the OSPF **"network"** command (see section 29.3.3).

If the setting is **"no passive-interface"**, the interfaces associated with the **"network"** command will automatically run OSPF, unless OSPF is explicitly disabled on the interface (see the **"passive"** command in section 29.3.15).

Similarly, if the setting is **"passive-interface"**, the interfaces associated with the **"network"** command will not run OSPF, unless OSPF is explicitly enabled on the interface (see the **"no passive"** command in section 29.3.15).

Use **"show passive-interface"** to show the default behaviour of OSPF interfaces (passive or active).

Default values Active (**"no passive-interface"**)

29.3.6 Configure Distribution of Default Route into OSPF Domain

Syntax [no] distribute-default [always] [metric-type <1|2>]
[metric <0-16777214>]

Context Router OSPF Configuration context

Usage Inject a default route into the OSPF domain, i.e., announce that this router can reach *network 0.0.0.0/0*.

Use the **"always"** keyword to make the router always advertise the default route, regardless if it has one or not. Without the "always" keyword, it will only advertise if it has one.

Use **"show distribute-default"** to show the whether this router is configured to inject a default route into the OSPF domain.

Default values Disabled (**"no distribute-default"**)

29.3.7 Configure Redistribution of External Route Information into OSPF Domain

Syntax [no] redistribute <connected|static|rip> [metric-type <1|2>] [metric <0-16777214>]

Context [Router OSPF Configuration](#) context

Usage Import external routing information into the OSPF domain. Redistribution of connected routes, static routes, and routes learnt via RIP is handled independently, e.g., use **"redistribute rip"** to import routes learnt via RIP.

Use **"no redistribute"** to remove all redistribution, and **"no redistribute rip"** to remove redistribution of routes learnt via RIP, etc.

Use **"show how redistribute [<connected|static|rip>]"** to show the OSPF redistribution settings. Use **"show redistribute"** to show all redistribution settings, or **"show redistribute connected"**, etc., to show redistribute settings for specific types of redistribution.

Default values Disabled (**"no redistribute"**)

29.3.8 Configure Admin Distance for OSPF

Syntax [no] distance <1-255>

Context [Router RIP Configuration](#) context

Usage Configure admin distance for all routes learnt via OSPF. If the same route is learnt via different routing protocols (or as connected or static route), the route associated with the lowest admin distance will be used. For OSPF the admin distance defaults to 110. See also [sections 22.2.6](#) and [28.1.3](#).

Use **"no distance"** to reset the OSPF admin distance to its default value.

Use **"show distance"** to show the configured OSPF admin distance value.

Default values 110

29.3.9 Manage area specific settings

Syntax [no] area <AREAID>

Context Router OSPF Configuration context

Usage Enter the OSPF Area Configuration context of the specified *AREAID* to configure area specific settings, such as area type (regular, stub, nssa), inter-area route summarisation, etc.

Use **"no area <AREAID>"** to remove specific for a single area, and **"no area"** to remove specific settings for all areas.

Use **"show area [<AREAID>]>"** to show a summary of area specific settings. Use **"show area"** to show settings for all areas, and **"show area <AREAID>"** to show settings for a specific area. (Also available as **"show"** command within the OSPF Area Configuration context.)

Default values Disabled (**"no area"**)

29.3.10 Configure an Area as Stub

Syntax [no] stub [no-summary]

Context OSPF Area Configuration context

Usage Configure an area as a *stub* area. To create a *stub* area, **all routers** in the area (ABRs as well as internal routers) must declare the area as stub.

To configure the area as a *totally stubby area*, all ABRs in the area should add the *no-summary* parameter to the stub command (**"stub no-summary"**).

Use **"no stub"** to let a stub (or nssa) area become a *regular* area.

Use **"show stub"** to show whether this area is configured as *stub* or not. If this is a stub area, it will show whether the **"no-summary"** keyword is set or not, i.e., if it is a *totally stubby area* or just a *stub* area.

Default values Disabled (i.e., areas are "regular" OSPF areas by default)

29.3.11 Configure an Area as NSSA

Syntax [no] nssa [no-summary]

Context [OSPF Area Configuration](#) context

Usage Configure an area as a *nssa* area. To create a *nssa* area, **all routers** in the area (ABRs as well as internal routers) must declare the area as *nssa*.

To configure the area as a *NSSA totally stub area*, all ABRs in the area should add the *no-summary* parameter to the *nssa* command ("**nssa no-summary**").

Use "**no nssa**" to let a *nssa* (or *stub*) area become a *regular* area.

Use "**show nssa**" to show whether this area is configured as *NSSA* or not. If this is a *NSSA* area, it will show whether the "**no-summary**" keyword is set or not, i.e., if it is a *NSSA totally stub* area or just a *NSSA* area.

Default values Disabled (i.e., areas are "regular" OSPF areas by default)

29.3.12 Configure default route cost in stub and NSSA areas

Syntax [no] default-cost

Context [OSPF Area Configuration](#) context

Usage Configure the cost of the default route injected into a *stub* area. This setting only applies to the ABRs of a *stub* or *NSSA* area.

Use "**no default-cost**" to use the *default* value for the *default cost* setting.

Use "**show default-cost**" to show the setting of the *default-cost*, i.e., the cost of the default route injected by ABRs into a *stub* or *NSSA* area.

Default values "default-cost 1"

29.3.13 Configure inter-area route summarisation and filtering

Syntax [no] range <NETWORK/LEN> [<advertise|not-advertise>]

Context [OSPF Area Configuration](#) context

Usage Configure inter-area route *summarisation* or route *filtering*.

Use the "**range <NETWORK/LEN>**" ("**range <NETWORK/LEN> advertise**" is equivalent) to aggregate routes (within this area) matching the specified <NETWORK/LEN> range, before distributing the routes outside this area. That is, all routes within this range are *summarised* as a single route, when advertised outside this area.

Use the "**range <NETWORK/LEN> not-advertise**" to prohibit routes (within this area) matching the specified <NETWORK/LEN> range, to be distributed outside this area. That is, routes within this range are *filtered*.

Use "**no range <NETWORK/LEN>**" to remove a specific summary/filter setting, or "**no range**" to remove all summary/filter settings for this area.

Use "**show range**" to show configured route summarisation and route filtering settings for this area.

Default values Disabled

29.3.14 Manage Interface Specific OSPF Settings

Syntax [no] ospf

Context [Interface Configuration](#) context

Usage Enter the Interface OSPF Configuration context, i.e., the context where Interface specific OSPF settings are configured.

Use "**no ospf**" to remove any specific OSPF settings for this interface.

Use "**show ospf**" to show a summary of OSPF settings for this interface. (Also available as "**show**" command within the Interface OSPF Configuration context.)

Default values Disabled (i.e., no interface specific OSPF settings)

29.3.15 Configure Interface OSPF Passive Settings

Syntax [no] passive [auto]

Context [Interface OSPF Configuration](#) context

Usage Control whether a specific interface should be passive ("**passive**"), active ("**no passive**"), or to automatically follow ("**passive auto**") the global OSPF setting declared by the "**[no] passive-interface**" setting in *router ospf* context (see [section 29.3.5](#)).

Use "**show passive**" to show the OSPF passive interface setting (passive, active or "auto") for this interface.

Default values Auto ("**passive auto**")

29.3.16 Configure Interface OSPF Cost Settings

Syntax [no] cost <1-65535>

Context [Interface OSPF Configuration](#) context

Usage Configure interface OSPF cost.

Use **"no cost"** to return to the default setting.



Note

As of WeOS v4.33.0 only static configuration of the interface OSPF cost setting is available. Support to let the cost automatically depend on the interface data rate is planned, but not yet implemented.

Use **"show cost"** to show the OSPF cost setting for this interface.

Default values 10 (this may be subject to change in later versions of WeOS).

29.3.17 Configure Interface OSPF Hello Interval Settings

Syntax [no] hello-interval <1-65535>

Context [Interface OSPF Configuration](#) context

Usage Configure OSPF hello interval (in seconds) for this interface.

Use **"no hello-interval"** to return to the default setting.



Note

The hello interval setting must be the same on neighbour routers.

Use **"show hello-interval"** to show the OSPF hello interval setting for this interface.

Default values 10 (seconds)

29.3.18 Configure Interface OSPF Dead Interval Settings

Syntax [no] dead-interval <1-65535>

Context [Interface OSPF Configuration](#) context

Usage Configure OSPF dead interval (in seconds) for this interface.

Use **"no dead-interval"** to return to the default setting.

**Note**

The dead interval setting must be the same on neighbour routers.

Use **"show dead-interval"** to show the OSPF dead interval setting for this interface.

Default values 40 (seconds)

29.3.19 Configure Interface OSPF Network Type

Syntax [no] network <broadcast|non-broadcast>

Context [Interface OSPF Configuration](#) context

Usage Configure OSPF network type for this interface.

Use this with the OSPF **"neighbor"** setting ([section 29.3.4](#)) to control the use of multicast or unicast Hello messages per link. That is, on NBMA links this should be set to non-broadcast to send unicast Hello.

Use **"network broadcast"** for regular broadcast links (default), and use **"network non-broadcast"** for NBMA links.

"no network" returns to the default setting.

Use **"show network"** to show the current setting.

Default values Broadcast

29.3.20 Configure Authentication of OSPF Messages

Syntax [no] auth <md5 [KEYID] | plain> <SECRET>

Context [Interface OSPF Configuration](#) context

Usage Configure authentication of OSPF messages *on this interface*. Two authentication methods are available:

- **MD5:** Use **"auth md5 <KEYID> <SECRET>"** to use a MD5 cryptographic authentication. MD5 secrets are text strings of 8-16 characters. A key identifier (0-255) is associated with MD5 keys. (Both the secret and the key identifier must be the same on neighbour routers.)

- *Plain*: Use "**auth plain <SECRET>**" to use a clear-text password as authentication. Plain text secrets are text strings of 4-8 characters. (The secret must be the same on neighbour routers.)

Use "**no auth**" to disable authentication of OSPF messages on this interface.

Use "**show auth**" to show the OSPF authentication setting for this interface.

Default values Disabled

29.3.21 Configure OSPF Designated Router Priority

Syntax [no] priority <0-255>

Context [Interface OSPF Configuration](#) context

Usage Configure the OSPF designated router priority, which affects the chance to become designated router on a broadcast network. A higher value increases the chance to become designated router.

Use "**priority 0**" to state that this router is not eligible as designated router on this interface/"IP subnet".

Use "**no priority**" to return to the default setting.

Use "**show priority**" to show the OSPF designated router election priority setting for this interface.

Default values 1 ("**priority 1**")

29.3.22 Show General OSPF Status

Syntax show ip ospf

Context [Admin Exec](#) context.

Usage Show general OSPF status information.

Default values Not applicable

29.3.23 Show OSPF Routes

Syntax show ip ospf route

Context [Admin Exec](#) context.

Usage Show the current least-cost routes learnt via OSPF. See also the command **"show ip route"** (section 22.7.26), which displays the full forwarding/routing table.

Default values Not applicable

29.3.24 Show OSPF Neighbours

Syntax `show ip ospf neighbor [<IFACE | detail>]`

Context [Admin](#) [Exec](#) context.

Usage Show current list of OSPF neighbours. Use **"show ip ospf neighbor IFACE"** to list OSPF neighbours for a specific interface, or the keyword **"detail"** to receive a more detailed listing.

Default values By default, neighbours on all interfaces are listed.

29.3.25 Show OSPF Database

Syntax

```
show ip ospf database [asbr-summary|external|network|router|summary],  
show ip ospf database max-age,  
show ip ospf database self-originate
```

Context [Admin](#) [Exec](#) context.

Usage Use **"show ip ospf database"** to list the current OSPF database. Various keywords can be added to view specific parts of the database.

Default values By default, the full database is listed.

Chapter 30

Dynamic Routing with RIP

This chapter describes WeOS support for the Routing Information Protocol (RIP.)

WeOS supports dynamic routing via RIP version 1 (RIPv1) and version 2 (RIPv2). RIP is relatively simple to setup, but does not handle topology changes as rapidly as the OSPF dynamic routing protocol (support for OSPF is described in [chapter 29](#)). Therefore, OSPF is generally preferred over RIP when it is possible to select dynamic routing protocol.

30.1 Overview of RIP Features

[Table 30.1](#) summarises RIP support in WeOS.

30.1.1 Introduction to RIP

RIP is an example of a *distance vector* routing protocol, and historically it has been one of the most widely used *intra-domain* unicast routing protocol within the Internet.

RIP is quite simple to configure; commonly you only have to enable RIP and define which interfaces to run RIP on. The router will automatically discover its neighbours and start to exchange routing information.

To enable RIP on all interfaces on R1 in [fig. 30.1](#), configuration shown below would suffice.

Feature	Web	CLI	General Description
General RIP settings			
RIP version	X	X	Section 30.1.1
RIP Timers	X	X	
Passive Interface Default	X	X	Section 30.1.4
RIP Networks/Interfaces	X	X	Section 30.1.1
RIP Neighbour	X	X	-"-
Redistribution (static, connected, OSPF)	X	X	Section 30.1.2
Distribute Default Route	X	X	-"-
RIP Admin Distance	X	X	
Authentication (MD5, plain)	X	X	Section 30.1.3
Passive interface	X	X	Section 30.1.4
Split Horizon	X	X	
Send RIP version	X	X	
Receive RIP version	X	X	

Table 30.1: Summary of RIP features.

Example

```
router
  rip
    network 10.0.1.0/24
    network 10.0.2.0/24
    network 10.0.3.0/24
  end
end
```

The command **"network 10.0.1.0/24"** will enable RIP on all interfaces included within the given range; in this example it states that RIP should be activated on the "upper interface" (i.e., the interface with address 10.0.1.3/24). It is also possible to specify the interfaces explicitly; assuming the three interfaces of R1 are called *vlan1*, *vlan2*, and *vlan3*, the following configuration would give the same result:

Example

```
router
  rip
    network vlan1
    network vlan2
    network vlan3
```

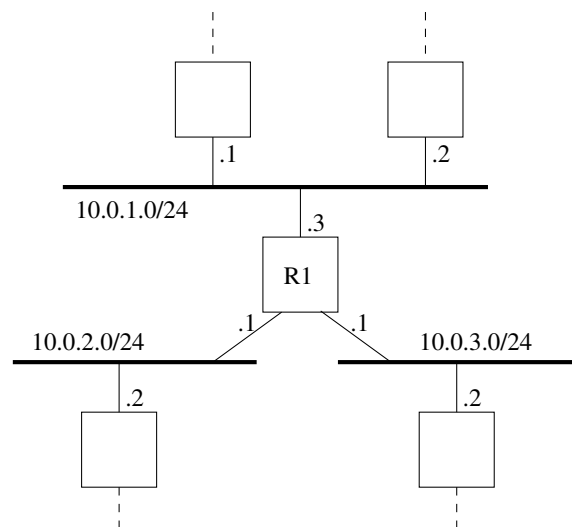

Figure 30.1: A router (R1) connected to other routers via three interfaces.

```
end
end
```

Both RIPv1[13] and RIPv2[31] are supported, and RIPv2 is used by default when RIP is enabled. The major difference between RIPv1 and RIPv2 is that RIPv2 supports flexible subnet masks (CIDR - classless inter-domain routing), while RIPv1 assumes that IP subnet masks follow the (deprecated) classful addressing scheme (class A, B and C). In addition, RIPv2 supports message authentication (section 30.1.3), and can therefore offer protection in situations when "foreign RIP routers" are connected (by mistake or as a deliberate attack) to a network and inject RIP routing messages. Thus, use of RIPv2 is preferred over RIPv1, except for cases where legacy equipment require the use of RIPv1.

RIPv2 routers exchange routing information using IP multicast (IP address 224.0.0.9)¹. In case a neighbour router is unable to handle IP multicast, the **"neighbor"** command enables the exchange of RIP messages using regular IP unicast.

30.1.2 Redistribution and Injection of Default Route

It is possible to redistribute routing information learnt externally (OSPF, connected routes or static routes) inside the RIP routing domain, using the **"redistribute"** command.

¹While RIPv2 use IP multicast, RIPv1 exchange routing information using broadcast.

You can also let a RIP router inject a default route (0.0.0.0/0) into your RIP domain, using the "**distribute-default**".

30.1.3 Authentication

To avoid that false routing information is injected into your network (deliberately or by mistake) it is possible to authenticate RIPv2 messages. Two authentication alternatives are available:

- *Plain*: Plain text authentication will protect against the situation when careless users attach a RIP router to your network *by mistake*. However, since the password is sent in plain text inside the RIP messages, it does not prohibit a deliberate attacker to inject routing information into your network. Plain text secrets are text strings of 4-16 characters.
- *MD5*: With MD5 authentication each RIP message will include a cryptographic checksum, i.e., message authentication code (MAC), based on a secret only known by the system administrator. MD5 secrets are text strings of 4-32 characters.

Authentication of RIP messages is configured per network interface, and is disabled by default.

Use of MD5 authentication is recommended. When using MD5 authentication, an associated *key identifier* must be specified. The purpose of the *key identifier* is to enable use of multiple MD5 keys in parallel when performing *key roll-over*. However, as of WeOS version v4.33.0 only a single RIP secret per interface is supported.

30.1.4 Passive interface

In some situations you may wish to include a router's subnets as part of the RIP routing domain without running RIP on the associated network interface. To accomplish this the *network* should be defined in the *router rip* context (as usual), and the related interface should be declared as *passive* in the *interface rip* context. Below is an example where network *10.0.3.0/24* should be included in the RIP domain, but where the associated interface (*vlan3*) is declared as passive.

Example

```
iface vlan3 inet static
...
... Skipping lines
```

```

...
address 10.0.3.1/24
rip
    passive
    end
end

router
rip
    network 10.0.1.0/24
    network 10.0.2.0/24
    network 10.0.3.0/24
    end
end

```

By default, RIP will run on all interfaces which have an associated network declared as a RIP network. If RIP should *not* run on such an interface, that interface should be declared as passive, as described above. However, WeOS is able to support use cases where the interfaces should be passive by default. The parameters controlling the behaviour are the "**passive-interface**" setting in *router rip* context, and the "**passive**" setting in the *interface rip* context.

- *passive-interface*: Use the "**[no] passive-interface**" setting in *router rip* context to control whether interfaces should be passive in RIP by default or not. Default setting: Active ("**no passive-interface**")
- *passive*: Use the "**[no] passive [auto]**" setting in *interface rip* context to control whether a specific interface should be passive ("**passive**"), active ("**no passive**"), or to automatically follow ("**passive auto**") the global RIP setting declared by the "**[no] passive-interface**" setting in *router rip* context. Default: Auto ("**passive auto**")

Below is an example, with the same result as above, where interfaces are passive in RIP by default.

 **Example**

```

iface vlan1 inet static
...
... Skipping lines
...
address 10.0.1.3/24
rip
    no passive
    end
end

iface vlan2 inet static
...

```

```
... Skipping lines
...
address 10.0.2.1/24
rip
    no passive
    end
end
router
rip
    passive-interface
    network 10.0.1.0/24
    network 10.0.2.0/24
    network 10.0.3.0/24
    end
end
```



30.2 RIP Web

The Web interface provides configuration of RIP.

Menu path: Configuration ⇒ Routing ⇒ RIP

RIP - Routing Information Protocol

Enabled

Version	RIPv2
RIP Networks/Interfaces	10.0.1.0/24  10.0.2.0/24  10.0.3.0/24  (Select to add)

Apply Cancel

[Show Advanced View](#) ▼

When entering the RIP configuration page the basic settings are presented.

Version	Select what RIP version (1 or 2) to use by default
RIP Networks/Interfaces	Enable RIP on the specified router Network/Interface
	Click this icon to delete a RIP Network or RIP Interface.

To view all settings, click on **Show Advanced View** (see next page).

Version	RIPv2 ▼		
RIP Networks/Interfaces	10.0.1.0/24		
	10.0.2.0/24		
	10.0.3.0/24		
	(Select to add) ▼		
Interfaces Default Passive	<input type="checkbox"/>		
Distribute Default	<input type="checkbox"/>		
Redistribute	<input type="checkbox"/> Connected		
	<input type="checkbox"/> Static		
	<input type="checkbox"/> OSPF		
Timers	Update	Invalid	Flush
	30 (s)	180 (s)	240 (s)
Neighbor(s)	<input type="text"/>		
Protocol Distance	120		

Interface Settings

Interface	Passive	Split Horizon	Send Version	Receive Version	Authentication	
vlan1	Auto	Enabled	Auto	Auto	None	
vlan2	Auto	Enabled	Auto	Auto	None	

Version	Select what RIP version (1 or 2) to use by default
RIP Networks/Interfaces	Enable RIP on the specified router Network/Interface
Interfaces Default Passive	Define whether RIP should be run on the interfaces defined (implicitly) via the RIP
Continued on next page	

Continued from previous page	
Distribute Default	Enable/disabled injection of a default route into the RIP domain
Redistribute	Enable/disabled import of external routing information into the RIP domain
Timers	Setup timers of the RIP protocol
Neighbor(s)	Setup RIP neighbor routers explicitly
	Click this icon to delete a RIP Network or RIP Interface.
Protocol Distance	The administrative distance used when selecting between multiple routes to the same destination.

30.2.1 Rip Status Page

Menu path: Status ⇒ Routing ⇒ RIP

RIP Status

```

Routing Protocol is "rip"
  Sending updates every 30 seconds with +/-50%, next due in 24 seconds
  Timeout after 180 seconds, garbage collect after 120 seconds
  Outgoing update filter list for all interface is not set
  Incoming update filter list for all interface is not set
  Default redistribution metric is 1
  Redistributing:
  Default version control: send version 2, receive version 2
    Interface      Send Recv  Key-chain
  Routing for Networks:
  Routing Information Sources:
    Gateway      BadPackets BadRoutes  Distance Last Update
  Distance: (default is 120)
    
```

Auto-Refresh: Off, [5s](#), [15s](#), [30s](#), [60s](#)

Show the status of RIP.

30.3 Managing RIP via the CLI

The table below shows RIP management features available via the CLI.

Command	Default	Section
<u>Configure General RIP Settings</u>		
router		Sec. 28.3.1
[no] rip	Disabled	Sec. 30.3.1
[no] version <1 2>	version 2	Sec. 30.3.2
[no] timers [update <SEC>]	update 30	Sec. 30.3.3
[invalid <SEC>]	invalid 180	
[flush <SEC>]	flush 240	
[no] network <NETWORK IFACE>		Sec. 30.3.4
[no] neighbor <ADDRESSLIST>		Sec. 30.3.5
[no] passive-interface	Active	Sec. 30.3.6
[no] distribute-default	Disabled	Sec. 30.3.7
[no] redistribute connected	Disabled	Sec. 30.3.8
[no] redistribute static	Disabled	Sec. 30.3.8
[no] redistribute ospf	Disabled	Sec. 30.3.8
[no] distance <1-255>	120	Sec. 30.3.9
<u>Configure Interface Specific RIP Settings</u>		
interface <IFACE>		Sec. 22.6.1
[no] rip		Sec. 30.3.10
[no] passive [auto]	Auto	Sec. 30.3.11
[no] split-horizon [poisoned-reverse]	Enabled	Sec. 30.3.12
[no] send-version <1,2>	Auto	Sec. 30.3.13
[no] receive-version <1,2>	Auto	Sec. 30.3.14
[no] auth <md5 [keyid] plain> <SECRET>	Disabled	Sec. 30.3.15
<u>View RIP Status</u>		
show ip rip		Sec. 30.3.16

30.3.1 Activate RIP and Manage General RIP Settings

Syntax [no] rip

Context Router Protocol Configuration context

Usage Enter the Router RIP Configuration context, and *activate* RIP with default settings if RIP is not activated already. Instead of running **"rip"** from the Router Protocol Configuration context, you can use **"router rip"** directly from the Global Configuration context.

Use **"no rip"** to disable RIP and delete all existing RIP configuration.

Use **"show rip"** to show a summary of all general RIP settings. Also available as **"show"** command within the Router RIP Configuration context.

Default values Disabled (no rip)

30.3.2 Configure Default RIP Version

Syntax [no] version <1|2>

Context Router RIP Configuration context

Usage Select what RIP version (1 or 2) to use by default, both with respect to sending and receiving of RIP messages. The setting can be overridden per interface using the **"receive-version"** (section 30.3.14) and **"send-version"** (section 30.3.14) respectively.

Use **"no version"** to return to the default setting.

Use **"show version"** to show the default RIP version setting.

Default values RIPv2 (version 2)

30.3.3 Configure RIP Protocol Timers

Syntax [no] timers [update <SEC>] [invalid <SEC>] [flush <SEC>]

Context Router RIP Configuration context

Usage Several timers of the RIP protocol can be changed using the *timers* command. All timers take a value between <5-2147483647> seconds.

- The *update* timer controls the interval between sending unsolicited *Response Messages* to all neighboring routers.
- The *invalid* timer controls the time before a route is expired and removed from the kernel routing table. It is kept for *flush – invalid* seconds in the internal RIP routing table to notify neighbors that a route has been dropped.

- The *flush* timer should be longer than the *invalid* timer. It controls the time when a route is finally cleared from the routing table.

**Important**

| All routers should have the same timings setup.

Use "**show timers**" to show the configured RIP protocol timers.

Default values Use "**no timers**" to return to the default timers:

update 30 sec

invalid 180 sec

flush 240 sec

**Example**

```
timers update 5 invalid 15 flush 30
```

This sends out updates every five seconds, invalidates a route if a router is not heard from in 15 seconds and flushes the route after an additional 15 seconds.

30.3.4 Enable RIP on an Interface

Syntax [no] network <NETWORK/LEN | IFACE>

Context [Router RIP Configuration](#) context

Usage Enable RIP on the specified router interface. The interface can be specified either explicitly ("**network <IFACE>**") or implicitly giving the IP subnet associated with the interface ("**network <NETWORK/LEN>**").

Use "**no network <IFACE>**" and "**no network <NETWORK/LEN>**" to remove an existing "**network**" entry.

Use "**show network**" to show the RIP network settings, i.e., which interfaces/subnets that are included in the RIP routing domain.

Default values Disabled, i.e., when first activating RIP ([section 30.3.1](#)), RIP will not be enabled on any interface.

30.3.5 Configure Unicast Neighbor

Syntax [no] neighbor <ADDRESSLIST>

Context Router RIP Configuration context

Usage Configure one or more RIP neighbor routers explicitly. This is useful in case the neighbor router is unable to handle IP multicast. An **"ADDRESSLIST"** is a comma-separated list of IPv4 address, e.g, **"neighbor 192.168.1.1,192.168.3.2"**. Calling the **"neighbor"** command twice (with arguments **"192.168.1.1"** and **"192.168.3.2"** respectively) would be equivalent.

Use **"no neighbor"** to remove all configured neighbours, and **"no neighbor <ADDRESSLIST>"** to remove a specific neighbour settings.

Use **"show neighbor"** to show the configured RIP Unicast Neighbours.

Default values Disabled (No neighbours defined)

30.3.6 Configure Interface Default Active/Passive Setting

Syntax [no] passive-interface

Context Router RIP Configuration context

Usage Define whether RIP should be run on the interfaces defined (implicitly) via the RIP **"network"** command (see [section 30.3.4](#)).

If the setting is **"no passive-interface"**, the interfaces associated with the **"network"** command will automatically run RIP, unless RIP is explicitly disabled on the interface (see the **"passive"** command in [section 30.3.11](#)).

Similarly, if the setting is **"passive-interface"**, the interfaces associated with the **"network"** command will not run RIP, unless RIP is explicitly enabled on the interface (see the **"no passive"** command in [section 30.3.11](#)).

Use **"show passive-interface"** to show the default behaviour of RIP interfaces (passive or active).

Default values Active (**"no passive-interface"**)

30.3.7 Configure Distribution of Default Route into RIP Domain

Syntax [no] distribute-default

Context Router RIP Configuration context

Usage Inject a default route into the RIP domain, i.e., announce that this router can reach *network 0.0.0.0/0*.

Use "**no distribute-default**" to stop this router from injecting a default route into the RIP domain.

Use "**show distribute-default**" to show the RIP redistribution settings. Use "**show redistribute**" to show all redistribution settings, or "**show redistribute connected**", etc., to show redistribute settings for specific types of redistribution.

Default values Disabled ("**no distribute-default**")

30.3.8 Configure Redistribution of External Route Information into RIP Domain

Syntax [no] redistribute <connected|static|ospf>

Context Router RIP Configuration context

Usage Import external routing information into the RIP domain. Redistribution of connected routes, static routes, and routes learnt via OSPF is handled independently, e.g., use "**redistribute ospf**" to import routes learnt via OSPF.

Use "**no redistribute**" to remove all redistribution, and "**no redistribute ospf**" to remove redistribution of routes learnt via OSPF, etc.

Use "**show redistribute [<connected|static|rip>]**" to show the RIP redistribution settings. Use "**show redistribute**" to show all redistribution settings, or "**show redistribute connected**", etc., to show redistribute settings for specific types of redistribution.

Default values Disabled ("**no redistribute**")

30.3.9 Configure Admin Distance for RIP

Syntax [no] distance <1-255>

Context Router RIP Configuration context

Usage Configure admin distance for all routes learnt via RIP. If the same route is learnt via different routing protocols (or as connected or static route), the

route associated with the lowest admin distance will be used. For RIP the admin distance defaults to 120. See also [sections 22.2.6](#) and [28.1.3](#).

Use **"no distance"** to reset the RIP admin distance to its default value.

Use **"show distance"** to show the configured RIP admin distance value.

Default values 120

30.3.10 Manage Interface Specific RIP Settings

Syntax [no] rip

Context [Interface Configuration](#) context

Usage Enter the Interface RIP Configuration context, i.e., the context where Interface specific RIP settings are configured.

Use **"no rip"** to remove any specific RIP settings for this interface.

Use **"show rip"** to show a summary of RIP settings for this interface.

Default values Disabled (i.e., no interface specific RIP settings)

30.3.11 Configure Interface RIP Passive Settings

Syntax [no] passive [auto]

Context [Interface RIP Configuration](#) context

Usage Control whether a specific interface should be passive (**"passive"**), active (**"no passive"**), or to automatically follow (**"passive auto"**) the global RIP setting declared by the **"[no] passive-interface"** setting in *router rip* context (see [section 30.3.6](#)).

Use **"show passive"** to show the RIP passive interface setting (passive, active or "auto") for this interface.

Default values Auto (**"passive auto"**)

30.3.12 Configure Split Horizon Setting

Syntax [no] split-horizon [poisoned-reverse]

Context [Interface RIP Configuration](#) context

Usage Enable or disable *split horizon* on this interface, with optional *poison reverse*. Split horizon is a RIP mechanism to mitigate the *counting to infinity* issue appearing in distance vector protocols such as RIP. Poisoned reverse is a variant where the router actively advertises routes as unreachable over the interface which they were learned. The effect of such an announcement is to immediately remove most looping routes before they can propagate through the network.

Use **"show split-horizon"** to show whether *split horizon* is enabled on this interface or not. If the optional *poisoned reverse* setting is enabled, that is also stated.

Default values Enabled (**"split-horizon"**), with poison reverse disabled.

30.3.13 Configure RIP Version for Sending on this Interface

Syntax [no] send-version <1,2>

Context [Interface RIP Configuration](#) context

Usage Control whether this interface should use the global RIP version setting ([section 30.3.2](#)) when sending RIP messages on this interface (**"no send-version"**), or to override the global setting by sending RIPv1 (**"send-version 1"**), RIPv2 (**"send-version 2"**), or both RIPv1 and RIPv2 (**"send-version 1,2"**).

Use **"no send-version"** to remove override settings and return to *auto* setting. (Override can also be removed for individual versions, e.g., **"no send-version 1"** to remove version 1 as override setting.)

Use **"show send-version"** to show RIP version override settings when accepting incoming RIP messages on this interface.

Default values Auto (**"no send-version"**)

30.3.14 Configure RIP Version for Receiving on this Interface

Syntax [no] receive-version <1,2>

Context [Interface RIP Configuration](#) context

Usage Control whether this interface should use the global RIP version setting ([section 30.3.2](#)) when accepting incoming RIP messages on this interface (**"no receive-version"**), or to override the global setting by accept-

ing RIPv1 ("**receive-version 1**"), RIPv2 ("**receive-version 2**"), or both RIPv1 and RIPv2 ("**receive-version 1,2**").

Use "**no receive-version**" to remove override settings and return to *auto* setting. (Override can also be removed for individual versions, e.g., "**no receive-version 1**" to remove version 1 as override setting.)

Use "**show receive-version**" to show RIP version override settings when accepting incoming RIP messages on this interface.

Default values Auto ("**no receive-version**")

30.3.15 Configure Authentication of RIP Messages

Syntax [no] auth <md5 [KEYID] | plain> <SECRET>

Context [Interface RIP Configuration](#) context

Usage Configure authentication of RIP messages *on this interface*. Two authentication methods are available:

- *MD5*: Use "**auth md5 <KEYID> <SECRET>**" to use a MD5 cryptographic authentication. MD5 secrets are text strings of 4-32 characters. A key identifier (0-255) is associated with MD5 keys. (Both the secret and the key identifier must be the same on neighbour routers.)
- *Plain*: Use "**auth plain <SECRET>**" to use a clear-text password as authentication. Plain text secrets are text strings of 4-16 characters. (The secret must be the same on neighbour routers.)

Use "**no auth**" to disable authentication of RIP messages on this interface.

Use "**show auth**" to show the RIP authentication setting for this interface.

Default values Disabled

30.3.16 Show RIP Status Information

Syntax show ip rip (or simply "**show rip**")

Context [Admin Exec](#) context.

Usage Show RIP status information, e.g., active interfaces, discovered RIP neighbours, etc.

Default values Not applicable

Chapter 31

IP Multicast Routing

This chapter describes the mechanisms involved in IP multicast routing and how to setup and debug static multicast routing in WeOS.

31.1 Summary of WeOS Multicast Routing Features

Feature	Web	CLI	General Description
Enable IP Forwarding	X	X	Section 31.1.1
Enable IP Multicast Forwarding	X	X	-"-
Configure Static Multicast Routes	X	X	-"-
Multicast Routing Statistics	X	X	-"-
<u>Related Settings</u>			
Layer-2 multicast forwarding			
IGMP Snooping	X	X	Section 31.1.3
Static Multicast Router Ports	X	X	-"-
Static MAC FDB entries		X	-"-
Block local ping responses	X	X	Section 31.1.4
VRRP control of IP Multicast	X	X	Section 32.1.6

31.1.1 Overview of IP multicast

Multicast is an efficient data distribution mechanism for purposes of reaching more than one receiver. IP multicast applications, such as a camera, need only send one packet to reach a group of receivers. The network infrastructure, switches and routers, send a copy of the packet to each subscriber of the group.

A multicast group is an IP address. In IPv4 the entire 224.0.0.0/4 block is reserved, i.e., 224.0.0.0 – 239.255.255.255. However, not all address are available to the end-user and some use-cases may not provide the most optimal distribution in switched (layer-2) networks.

The 224.0.0.0/24 subnet (224.0.0.*) is reserved for control protocols, e.g., IGMP, RIPv2 and OSPF.

Like regular IP addresses IP multicast groups must be translated to Ethernet (LAN) MAC addresses. However, the range of reserved MAC multicast addresses is too small, see RFC1112[6] for details.

The lack of reserved multicast MAC addresses may be a problem in switched networks where the switch fabric often only supports IGMP Snooping (Sec. 21.1), i.e., filtering, per MAC address. E.g., subscribers of group 224.1.2.3 will also receive all traffic sent to group 225.1.2.3.

This is due to the mapping to MAC addresses, in our case

- 224.1.2.3 maps to 01:00:5e:01:02:03
- 225.1.2.3 maps to 01:00:5e:01:02:03
- etc.

On a per LAN basis (layer-2) IP multicast is managed by IGMP (routers) and IGMP Snooping (switches). Managing multicast on this level is important due to its inherent broadcast nature. Knowledge of this can be very important when debugging multicast (re)distribution and routing.

Routing of IP multicast can be done either dynamically (e.g., DVMRP, PIM) or statically. WeOS currently only supports the latter.

31.1.2 Static multicast routing

Contrary to static unicast, multicast has a separate routing table and is handled a little bit differently. To be able to route multicast you need the following:

- Enable IP forwarding

- Enable IP multicast forwarding
- Setup a multicast route
- Multicast data with a TTL > 1

The two enable flags simply control routing and multicast routing, respectively. However, if IP forwarding is disabled toggling the multicast forwarding flag will have no effect.

A static multicast route is made up of a *group*, an *inbound interface*, an optional *sender address* and one or more *outbound interfaces*. There can be at most 128 multicast routes with at most 16 outbound interfaces per route.

The source, or *sender address*, is optional in WeOS but the underlying Linux kernel still needs a source address to be able to route the traffic. The multicast routing daemon in WeOS manages this by adding rules to the kernel on-demand based on the “source-less” rules specified. For each new multicast stream, from a given group and inbound interface, the routing daemon checks to see if a matching mroute rule exists and then adds that source specific rule to the kernel. This may cause some initial delays in activation of such rules.

31.1.3 IP multicast and IGMP Snooping

In LAN networks IGMP Snooping is often employed in switches to limit the distribution of IP multicast. Without subscribers to a certain multicast group, distribution of a camera’s multicast stream is halted at the first switch. When IGMP Snooping is disabled, the camera’s multicast stream is instead broadcast to all ports on the switch, or all ports in the VLAN. For details, see [Sec. 21.1](#) and [Sec. 15.1.5](#).

In currently available network equipment, as well as modern operating systems, IGMP is a well established protocol that works well. There may however still exist older networking equipment, e.g., Programmable Logic Controllers (PLCs), that does not know how to join a multicast group using IGMP. For such devices to receive multicast it is possible in WeOS to either disable IGMP Snooping per VLAN, add a specific FDB MAC entry for the multicast group to open up additional ports in the switch, or use the multicast router port feature to forward all multicast on a given port.

31.1.4 Blocking Local Ping Responses

To ensure that the multicast stream actually is received for routing by the CPU, the WeOS router sends an IGMP join for the multicast group to be routed on the

given inbound interface. This has the odd side-effect that the router now also responds to local pings to that group. To disable this, see [Sec. 22.7.18](#).

31.2 Managing Multicast Routing via Web Interface

Menu path: Configuration ⇒ Routing ⇒ Common

The WeOS web interface has full support for managing, configuring and debugging, static IP multicast routing.

To be able to route multicast both the Unicast and Multicast forwarding tick boxes must be checked. The Unicast tick box is actually the big switch that controls all IP routing.

Routing - Common Settings

IP Forwarding Enabled

Unicast	<input checked="" type="checkbox"/>
Multicast	<input checked="" type="checkbox"/>

Apply Cancel

Figure 31.1: Enable IP multicast forwarding.

31.2.1 Adding a Static Multicast Route

Menu path: Configuration ⇒ Routing ⇒ Static Multicast

By default no static multicast routes are setup. Click on New to create a new static multicast route.

Static Multicast Routes

No static multicast routes configured.

New

Figure 31.2: No multicast routes enabled by default.

Enter the IPv4 multicast group address, the inbound interface and the source of the sender.

Static Multicast Route - New

Group Address	<input type="text" value="225.1.2.3"/>
Source Address	<input type="text" value="192.168.2.42"/>
Inbound Interface	<input type="text" value="vlan1"/>
Outbound Interface(s)	<input type="text" value="Select to add"/> <input type="button" value="Add"/>

Figure 31.3: Declare multicast group, inbound interface and source of sender.

Add outbound interfaces to your multicast route by selecting them in the drop down and clicking Add for each one.

Static Multicast Route - New

Group Address	<input type="text" value="225.1.2.3"/>
Source Address	<input type="text" value="192.168.2.42"/>
Inbound Interface	<input type="text" value="vlan1"/>
Outbound Interface(s)	vlan2 <input type="button" value="trash"/> vlan3 <input type="button" value="trash"/> <input type="text" value="Select to add"/> <input type="button" value="Add"/>

Figure 31.4: Select an outbound interface and press Add for each one.

31.2.2 Adding a Sourceless Static Multicast Route

Menu path: Configuration ⇒ Routing ⇒ Static Multicast

WeOS supports "source-less" static multicast routes as well, simply leave the *Source Address* field empty.

Static Multicast Route - New

Group Address	<input type="text" value="225.1.2.3"/>
Source Address	<input type="text"/>
Inbound Interface	<input type="text" value="vlan1"/>
Outbound Interface(s)	<input type="text" value="vlan2"/> <input type="button" value="trash"/>
	<input type="text" value="vlan3"/> <input type="button" value="trash"/>
	<input type="text" value="Select to add"/> <input type="button" value="Add"/>

Figure 31.5: Source-less: declare only multicast group, inbound and outbound interfaces.

31.2.3 Overview of Configured Multicast Routes

Menu path: Configuration ⇒ Routing ⇒ Static Multicast

Static Multicast Routes

Group Address	Source Address	Inbound Interface	Outbound Interface(s)	
225.1.2.3	192.168.2.42	vlan1	vlan2 , vlan3	 
225.3.2.1	ANY	vlan1	vlan2 , vlan3	 

Figure 31.6: Overview of configured static multicast routes.

31.2.4 Deleting a Static Multicast Route

Menu path: Configuration ⇒ Routing ⇒ Static Multicast

In the overview, click the trashcan icon for the static multicast routing rule to delete.

Static Multicast Route - Delete

Really delete Static Multicast Route?

Group Address	225.3.2.1
Source Address	ANY
Inbound Interface	vlan1

Figure 31.7: Confirm deleting a static multicast route by clicking Yes.

31.2.5 Show Kernel Multicast Routing Table

Menu path: Status ⇒ Routing ⇒ Multicast Routes

The actual kernel multicast routing table is very useful to inspect for debugging, e.g., seeing the amount of packets routed or any on-demand added "source-less" multicast routes.

Multicast Routes

Group Address	Source Address	Inbound Interface	Packets	Bytes	Invalid	Outbound Interface(s)
225.3.2.1	192.168.2.42	vlan1	28	2352	0	vlan2, vlan3
225.1.2.3	192.168.2.42	vlan1	0	0	0	vlan2, vlan3

Auto refresh: Off, [5s](#), [15s](#), [30s](#), [60s](#)

Refresh

Figure 31.8: Kernel multicast routing table, active multicast routes.

31.3 Managing Multicast Routing via CLI

The following table shows CLI commands relevant for managing, debugging and querying static multicast routes in WeOS.

Command	Default	Section
<u>Configure IP multicast routing</u>		
ip		
[no] multicast-forwarding	Disabled	Section 31.3.1
[no] mroute group <MCADDR> in <IFNAME> [src <IPADDR>] out <IFNAME-LIST>		Section 31.3.2
<u>Show IP multicast routing status</u>		
show ip mroute		Section 31.3.3

There are some additional CLI settings which may be of interest when configuring IP multicast on your unit. The table below lists the most relevant settings.

Command	Default	Section
<u>Related settings (IGMP, MAC FDB, VRRP, etc.)</u>		
fdb		
[no] mac <MACADDR> port <PORTLIST>		Section 15.4.3
vlan <VID>		
[no] igmp	Enabled	Section 15.4.15
ip		
[no] mcast-router-ports <PORTLIST>	Disabled	Section 21.4.6
[no] forwarding	Enabled	Section 22.7.4
icmp		
[no] broadcast-ping	Enabled	Section 22.7.18
firewall		
[no] filter [ARGS ...]		Section 33.3.3
[no] nat [ARGS ...]		Section 33.3.6

Continued on next page

Continued from previous page		
Command	Default	Section
iface <IFNAME> vrrp <INSTANCE> [no] mroute-ctrl	Disabled	Section 32.3.12
Related status commands (MAC FDB, IGMP, etc.)		
show fdb		Section 15.4.22
show ip igmp		Section 21.4.10
show firewall		Section 33.3.14

31.3.1 Enable/disable IP multicast forwarding

Syntax [no] multicast-forwarding

Context [IP Configuration](#) context

Usage Enable/disable IP multicast forwarding (multicast routing). Use command **"multicast-forwarding"** to enable IP multicast forwarding, given that IP forwarding (routing) is enabled (**"forwarding"**, see [section 22.7.4](#)).

"no multicast-forwarding" disables IP multicast forwarding.

Use **"show multicast-forwarding"** to show whether IP multicast forwarding is enabled or disabled.

Default values Disabled (**"no multicast-forwarding"**)

31.3.2 Configure static multicast routes

Syntax [no] mroute group <MCADDR> in <IFNAME>
 [src <IPADDR>] out <IFNAME-LIST>

group <MCADDR> IPv4 multicast group to route

in <IFNAME> Inbound interface for multicast stream

src <IPADDR> Optional IPv4 sender address of multicast stream

out <IFNAME-LIST> Comma separated list of destination/outbound interfaces for multicast stream. MAX:16

Context IP Configuration context

Usage Add/remove a static multicast route.

If the *src* field is omitted from an *mroute* rule, any multicast stream matching the given group and inbound interface will be added on-demand to the kernel multicast routing table. Use the *Admin Exec* command `show ip mroute` to inspect.

Use the "no"-form of the command to remove rules. The *src* and *out* arguments are not needed, e.g., "**no mroute group 225.1.2.3 in vlan1**". Without any arguments "**no route**" will remove all configured static multicast routes.

Use "**show mroute**" to list configured static IP multicast routes.

31.3.3 Show IP multicast status and statistics

Syntax `show ip mroute`

Context Admin Exec context

Usage Show IP Multicast Forwarding table and statistics.

This command is useful to inspect the actual routes setup in the kernel multicast routing table. In particular this command is useful when having setup "source-less" *mroute* rules.

Default values Not applicable.

Example Assume you have configured the following *mroute* rules:

 **Example**

```
example:/config/ip/#> mroute group 225.1.2.3 src 192.168.2.42 in vlan1 out vlan2,vlan3
example:/config/ip/#> mroute group 225.3.2.1 in vlan1 out vlan2,vlan3
```

Then the resulting kernel multicast routing table may end up looking like this:

 **Example**

```
example:/#> show ip mroute
```

Group	Source	Inbound	Packets	Bytes	Invalid	Outbound
225.1.2.3	192.168.2.42	vlan1	0	0	0	vlan2, vlan3
225.3.2.1	192.168.2.20	vlan1	0	0	0	vlan2, vlan3

```
225.3.2.1      192.168.2.21   vlan1      0      0      0      vlan2, vlan3  
=====
```

The latter two entries have been added on-demand, this happens as soon as initial multicast data frames from unknown sources are received on interface *vlan1* destined for group 225.3.2.1.

The columns *Packets*, *Bytes* and *Invalid* denote the total number of packets, bytes and number of invalid packets per rule. Please note that when reconfiguring static multicast rules, or when related interfaces go up/down the statistics are reset. So do not rely on them for accurate measurements, they only exist to aid in debugging.

Chapter 32

Virtual Router Redundancy (VRRP)

This chapter describes WeOS support for the Virtual Router Redundancy Protocol version 2 (VRRPv2)[[27](#)] and version 3 (VRRPv3)[[35](#)].

VRRP is a standard protocol to enable redundancy between a host and its router, in case the router goes down. VRRP can also be used for *load balancing* purposes.

VRRP provides router redundancy for regular (unicast) IP traffic by letting multiple routers share a virtual IP and MAC address. If the (master) router goes down, a *backup* router will automatically take over.

WeOS provides an optional feature, where the VRRP state (*master* or *backup*) is used to enable/disable *IP multicast routing* of incoming IP multicast packets. With this option enabled, the backup router will prevent the routing of (static) IP multicast routes in addition to IP unicast routing. See [chapter 31](#) for information on support for static IP multicast routing in WeOS.

32.1 Introduction to WeOS VRRP support

The table below summarises VRRP support in WeOS.

Feature	Web	CLI	General Description
VRRP Instances	X	X	Sections 32.1.1-32.1.2
Virtual Router IDs (VRIDs)	X	X	Sections 32.1.1-32.1.2
Virtual Router IP Address	X	X	Sections 32.1.1-32.1.2
Virtual Router Priority	X	X	Sections 32.1.1-32.1.2
Static Priority	X	X	Sections 32.1.1-32.1.2
Dynamic Priority	X	X	Sections 32.1.1-32.1.2
Preemption control	X	X	Sections 32.1.1-32.1.2
<u>Version Specific Settings</u>			
VRRP versions (v2/v3)	X	X	Sections 32.1.2-32.1.3
Advertisement Interval	X	X	Sections 32.1.2-32.1.3
Regular (v2)	X	X	Sections 32.1.2-32.1.3
Fast (v3)	X	X	Sections 32.1.2-32.1.3
Message authentication (v2)	X	X	Section 32.1.4
<u>Advanced Features</u>			
Synchronisation Groups	X	X	Section 32.1.5
Multicast Routing Control	X	X	Section 32.1.6
Load balancing	X	X	Section 32.1.7

32.1.1 VRRP Overview

The primary objective of VRRP is to enable redundancy between a *host* and its *neighbour router*, i.e., you can deploy additional routers on an IP subnet as backup routers, and have one of the backup routers to automatically take over if the primary router fails. [Fig. 32.1](#) can be used to illustrate the need for VRRP in such a scenario.

- A host will typically have an IP setting where the default gateway points to a specific router. An example is given in [fig. 32.1a](#), where the host (H) will send all traffic towards the Internet via Router 1 (R1) with IP address 192.168.1.1. If R1 fails, the host will lose Internet connectivity even though a redundant path (R2) happens to exist.

- VRRP enables routers to share a virtual IP (VIP) address. The router with the highest priority acts as master for the VIP address, while the other routers are backups in case the master fails. Fig. 32.1b illustrates the use of VRRP. R1 and R2 are both responsible for the VIP address (192.168.1.3), with R1 as master since it has higher priority (150>100). If R1 goes down, R2 will become master of the VIP address and communication can automatically resume. Note that the default gateway of the host is configured to the VIP address.

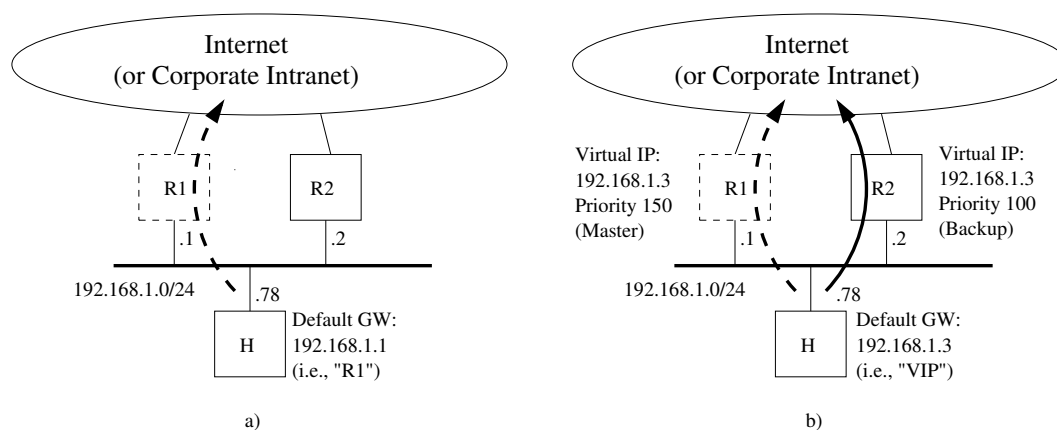

Figure 32.1: Illustrating the need for VRRP to support redundancy: a) Host (H) loses connectivity when Router 1 (R1) fails. b) Host (H) can continue to communicate even though Router 1 (R1) fails, since VRRP enables Router 2 (R2) to take over.



Note

VRRP enables a host to have redundant routers. For redundancy "router to router", dynamic routing protocols such as OSPF ([chapter 29](#)) or RIP ([chapter 30](#)) can be used.

32.1.2 Common VRRP parameters

Some common VRRP parameters are listed below:

1. *VRRP instance*: WeOS allows you to configure up to 32 VRRP instances per unit. Each instance will operate on a (VLAN) *interface* (e.g., *vlan1*) and be assigned a virtual router identifier (VRID), see [item 2](#) below.

Note

The "VRRP instance number" is a parameter only used by WeOS for internal book keeping, e.g., when establishing VRRP synchronisation groups (section 32.1.5). The VRRP instance number is not exchanged in any VRRP message.

2. *Virtual Router Identifier (VRID)*: Each instance is assigned a virtual router instance identifier (VRID) in range 0-255. All routers on a LAN, acting as virtual routers for a specific virtual IP address, must be configured with the same VRID. That is, R1 and R2 in fig. 32.1b should have the same VRID, e.g., "33".

Note

As of WeOS v4.33.0, a specific VRID (such as "33") can only be used once per WeOS unit. Using the same VRID in a second VRRP instance is not possible on a WeOS unit, not even on another LAN.

3. *Virtual IP address (VIP)*: WeOS allows you to configure one VIP address per VRRP instance. When designing your network there are some restrictions to consider when selecting the VIP address.

- *Select VIP in correct IP subnet*: The VIP address should be in the same IP subnet as the regular IP address assigned to the interface (e.g., the VIP address in fig. 32.1b is 192.168.1.3, which is in the same subnet as R1's and R2's IP addresses on that subnet).
- *Select VIP not "owned" by any router*: Although it is possible to use an address assigned to (i.e., owned by) a router as the VIP address, it is recommended that a separate IP address is used.

Consider the example in fig. 32.1b): According to the recommendation, the chosen VIP address ("192.168.1.3") is separate from the addresses assigned to R1 ("192.168.1.1") and R2 ("192.168.1.2").

Although discouraged, it would have been possible to chose "192.168.1.1" as VIP address. Being the *owner* of the address, R1 must in that case be configured with priority 255, with dynamic priority disabled. More information on VRRP priority is found in item 5 below.

4. *Advertisement interval*: In VRRP, the master will announce its presence by sending VRRP Advertisements on a certain interval. For VRRPv2 the interval can be configured in range 1-255 seconds. VRRPv3 allows sub-second

intervals (in steps of 100 ms) in range 0.1-40 seconds. All VRRP routers associated with the same VRID must use the same VRRP version (see [section 32.1.3](#)), and must have the same advertisement interval setting.

A low VRRP advertisement interval gives faster fail-over (the time to detect that a master is down is roughly 3 times the advertisement interval).

Default advertisement interval: **1 (second)**

5. *VRRP Priority*: The VRRP priority parameter is used to define which router should become master of the VIP address when multiple routers are available. (If two routers with the same priority transitions to master state, the router with the highest IP address will win the election.)

The priority can be configured in range 1-255, where the value "255" should be used if (and only if) the router is also the *owner* of the VIP address (see the Note in [item 3](#) above). Default priority: **100**

WeOS supports *dynamic VRRP priority*. E.g., if the master router loses its Internet connection it should lower its priority dynamically (or even decline to be master), this to allow for a backup router to take over immediately. For example, if R1 in [fig. 32.1b](#) would lose its upstream connection, it could lower its priority to 30, whereby R2 would could take over if preemption is enabled.

In WeOS, dynamic VRRP priority is configured by mapping the status of an event trigger, typically a *ping trigger* (see [section 25.1](#)) to a *priority adjustment* value.

If a router is the *owner* of the VIP, it should be configured with priority "255", with dynamic priority disabled.

6. *VRRP Preemption*: The VRRP master election is not controlled by the priority setting alone; there is also a *preemption* parameter, which enables you to select to have a *deterministic* master election procedure (highest priority always becomes master), or a *sticky* behaviour where the elected master router would keep its role even when another router with higher priority later appears on the network. With *preemption* disabled, the second router would refrain from taking over as long as the current master continuous to send advertisements.

The exception to this is if the new router connected to the subnet is the VIP address *owner* (priority 255); the VIP owner will always preempt an existing master.

When preemption is enabled, an optional preemption delay parameter can be configured (default 0 seconds), which determines how long the router should wait until preemption is activated. Default: **Disabled**

 **Note**

When the instance belongs to a synchronized group, the instance with the shortest preemption delay will be used.

 **Note**

Preemption only occurs when starting or restarting a higher priority backup router, e.g. if a link down event occurs preemption will not be used.

A sample VRRP configuration for R1 in [fig. 32.1b](#) is shown below:

 **Example**

```
router vrrp 1
  iface vlan2
  address 192.168.1.3
  vrid 33
  priority 150
end
```

32.1.3 Selecting VRRP version (VRRPv2 or VRRPv3)

WeOS supports VRRP version 2 and version 3. The additions to version 3 is shorter advertisement interval (faster failover) and IPv6 support (not supported in WeOS). Authentication has been removed completely in version 3 since it was considered to not provide any real security. It is mandatory that the master and the backup routers uses the same VRRP version. Default: **VRRPv2**

32.1.4 Authentication (VRRPv2 only)

 **Warning**

Use of VRRP authentication is discouraged[14], as it may cause more harm than help.

For VRRPv2, WeOS supports a simple form of VRRP message authentication, enabling the inclusion of a plain-text password in the VRRP advertisements[27].

To avoid that multiple master routers appear on an IP subnet, a WeOS VRRP router will refrain from becoming master if it hears another router with mismatching VRRP authentication information.

32.1.5 VRRP Synchronisation Groups

VRRP synchronisation is a function to keep the VRRP role (master vs backup) the same for different VRRP instances on the same unit, see [fig. 32.2](#).

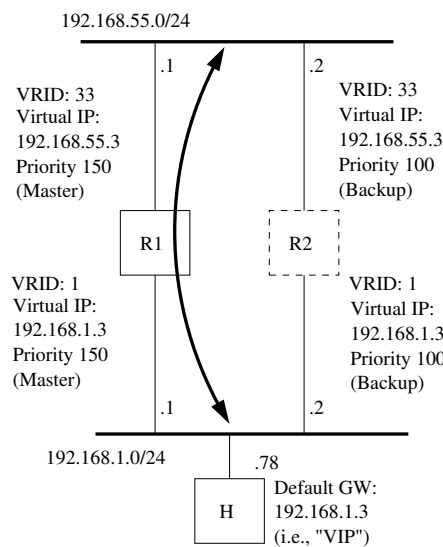

Figure 32.2: Illustrating a topology using synchronised groups. Both instances on R1 will always remain in master state as long no fault is detected (e.g. link down). On fault R1 will become backup on both instances and R2 will become master for both instances.

A synchronisation group consists of two VRRP instances. These two instances should be active on different VLAN network interfaces, e.g. VRID 1 on interface vlan1 can be synchronized with VRID 33 on interface vlan2. The VRRP instances on a unit will only take the master role if it considers itself to have the highest VRRP priority for both instances. If one of the VRRP instances in the synchronisation group would transition to backup state (e.g. link down), the other instance will also change state to backup, i.e. the instances in the synchronisation group will always have the same state.

32.1.6 VRRP Control of static IP Multicast Routing

When using static multicast routing and VRRP a problem that can occur is that the multicast packets will get duplicated. This can be avoided by using the VRRP multicast routing control. When using this feature, only the master router will forward incoming multicast traffic from the configured VRRP interface while the backup router will prevent the packets from being forwarded.

Note
The setting is applied per interface. It is not recommended to configure more than one instance per interface as this will lead to unpredictable results.

32.1.7 Load sharing

It is possible to use VRRP for load sharing between routers, and still provide redundancy, by having the routers acting as backup for each other. Fig. 32.3 shows a load sharing example. Here the VIP addresses reside within the same IP subnet. However, since WeOS supports multi-netting, the VIP addresses could be on different IP subnets.

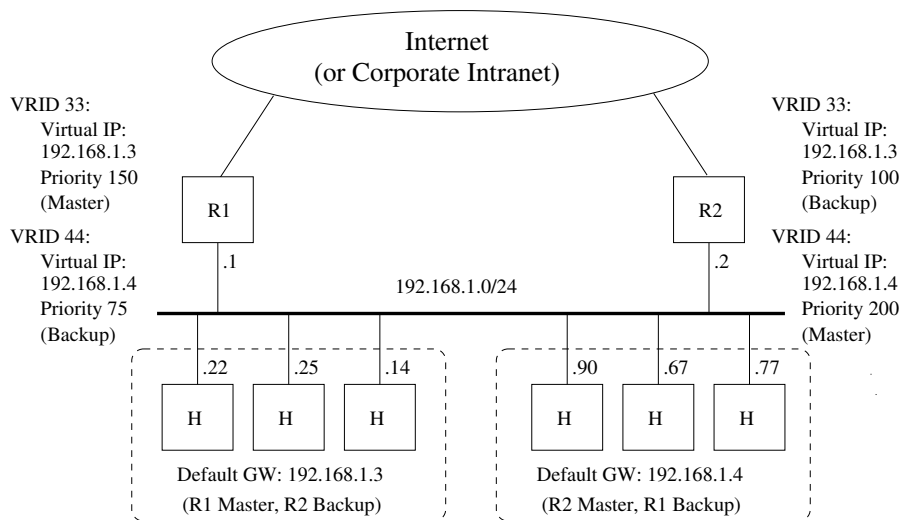

Figure 32.3: Example setup where R1 and R2 share the load from IP subnet 192.168.1.0/24, and using VRRP to backup each other.

32.2 Managing VRRP via the web interface

Menu path: Configuration ⇒ Routing ⇒ VRRP

The main VRRP configuration page lists the currently configured VRRP instances on all interfaces.

VRRP

Grouping	Interface	VRID		
<input type="checkbox"/>	[vlan3 vlan4	1 6		
<input type="checkbox"/>	vlan1	5		
<input type="checkbox"/>	vlan2	3		

VRRP

Grouping

Grouping	To work with groups for synchronised fail-over, select two instances or a group for grouping/ungrouping. A group is displayed with a [linking the grouped instances, and common background colour.
Interface	The interface on which to listen for VRRP information and act as gateway. Only VLAN interfaces may be selected.
VRID	Virtual Router ID. A unique ID common to those routers that will provide redundancy.
Edit	Click this icon to edit a VRRP instance.
Delete	Click this icon to remove a VRRP instance. You will be asked to acknowledge the removal before it is actually executed.
Button New	Click this button to create a new VRRP instance.
Button Group	For synchronised fail-over - first select two ungrouped VRRP instances and then click this button to group the instances.

Continued on next page

Continued from previous page	
Button Ungroup	For synchronised fail-over - first select one group of VRRP instances and then click this button to ungroup the instances. They will be left as two individual instances that has to be removed separately.

32.2.1 Create a new VRRP instance using the web interface

Menu path: Configuration ⇒ Routing ⇒ VRRP ⇒ New

VRRP

Interface	vlan2
Virtual Router ID	12
Virtual Address	192.168.2.45
Version	v2 <input type="radio"/> v3 <input checked="" type="radio"/>
Advertisement Interval (s)	1
Priority	100
Preemption	Enabled
Preemption Delay (s)	44
Multicast Routing Control	<input checked="" type="checkbox"/>

Dynamic Priority

Track Trigger	2 (ping)
Priority Adjustment	-45

Apply

Cancel

Interface	The interface on which to listen for VRRP information and act as gateway. Only VLAN interfaces may be selected.
Continued on next page	

Continued from previous page	
Virtual Router ID	A unique ID common to those routers that will provide redundancy.
Virtual Address	A virtual address that the routers will use when providing the gateway support. The VIP address should be in the same IP subnet as the regular IP address assigned to the interface
Version	VRRP version to use (v2 or v3).
Advertisement Interval	The interval in seconds how often a VRRP advertisement message will be sent out. Allowed values: v2: 1-255 seconds v3: 0.1-40 seconds, in 100 msec intervals between 0.1 and 1.0 (default: 1).
Advertisement Interval	The interval in seconds how often a VRRP advertisement message will be sent out. Allowed values: 1-255 seconds (default: 1)
Priority	A number used for election of current gateway. A higher number means a higher chance to become elected. If two routers has the same priority in an election, the router with the highest IP address will win. The value 255 should be used if (and only if) the router is also the owner of the virtual IP address. Allowed values: 1-255 seconds (default: 100)
Preemption	Enable/disable preemption and, if enabled, set a preemption delay. Preemption allows an elected router to remain as master for a time period If the new router is the virtual IP address owner (priority 255), it will always become the master. Default: Disabled
Multicast Routing Control	Let VRRP control multicast routing. If checked, multicast routing will be disabled automatically for this instance when entering BACKUP state. Only one VRRP instance per interface may be configured for controlling multicast routing. The checkbox is disabled if another instance is in control.

For more information on the different settings, see [section 32.1.1](#).

32.2.1.1 Dynamic Priority

Track Trigger	If not disabled, the alarm trigger selected will, if triggered, add the priority adjustment value to the router priority.
Priority Adjustment	A positive or negative number to add to the priority when the alarm has triggered. Allowed values: -255 to 255.

For more information on the different settings, see [section 32.1.1](#).

32.2.2 Edit VRRP settings using the web interface

Menu path: Configuration ⇒ Routing ⇒ VRRP ⇒ 

For description of fields, see [section 32.2.1](#).

32.2.3 VRRP Status Page

Menu path: Status ⇒ Routing ⇒ VRRP

VRRP Status

```

VRRP Instance      : vlan1_12
Interface          : vi-vlan1_12
Virtual Router ID  : 12
State              : INIT
Virtual IP address : 192.168.2.45/32 bcast 0.0.0.0
Advertisement interval : 1 sec
Preemption         : Enabled, delay 44 secs
Priority           : 100
Effective Priority  : 55
Authentication     : NONE
Master router      : 0.0.0.0 priority 0
Master down interval : 38.0
    
```

Auto refresh: Off, 5s, 15s, 30s, 60s

Refresh

Show the status of all configured VRRP instances.

32.3 Managing VRRP via the CLI

The VRRP CLI syntax has been changed from an approach where VRRP was configured *per (VLAN) interface* to an approach where VRRP instances are configured as a common router service. Entering the configuration via both methods has been supported since WeOS v4.9.x. When storing the configuration, WeOS v4.13.x uses the new (router service) style.

Command	Default	Section
<u>Configure VRRP Settings</u>		
router		Sec. 28.3.1
[no] vrrp <INSTANCEID>		Sec. 32.3.1
[no] iface <IFNAME>		Sec. 32.3.2
[no] vrid <VRID>		Sec. 32.3.3
[no] version <2 3>	2	Sec. 32.3.4
[no] address <ADDRESS>		Sec. 32.3.5
[no] interval <INTERVAL> [ms]	1	Sec. 32.3.6
[no] priority <1..255>	100	Sec. 32.3.7
[no] preempt [delay <0..1000>]	Disabled	Sec. 32.3.8
[no] auth <plain> <SECRET>	Disabled	Sec. 32.3.9
[no] track trigger <ID> adjust <DELTA>	Disabled	Sec. 32.3.10
[no] sync <INSTANCEID>	Diabled	Sec. 32.3.11
[no] mroute-ctrl	Disabled	Sec. 32.3.12
<u>View VRRP Status</u>		
show vrrp		Sec. 32.3.13

32.3.1 Create and Manage a VRRP Instance

Syntax [no] vrrp <INSTANCEID>

Context [Router Protocol Configuration](#) context

Usage Create, manage, or delete a VRRP instance. Use **"vrrp <INSTANCEID>"** to enter the VRRP Instance Configuration context of the specified VRRP instance (INSTANCEID can be in the range 1-32). If the instance does not already exist, it will be created.

Use **"no vrrp <INSTANCEID>"** to remove a specific VRRP instance, or **"no vrrp"** to remove all configured VRRP instances.

At most 32 VRRP instances can be created per unit.

Use **"show vrrp [INSTANCE]"** to show summary of VRRP settings. Use **"show vrrp"** to list settings for all configured VRRP instances, and **"show vrrp INSTANCE"** to list settings for a specific VRRP instance.

Default values Disabled

32.3.2 Configure VRRP interface

Syntax [no] iface <IFNAME>

Context [VRRP Instance Configuration](#) context

Usage Configure VRRP interface.

An interface is a mandatory setting (**"no iface"** is an invalid setting).

Use **"show iface"** to show the configured interface for this VRRP instance.

Default values None

32.3.3 Configure Virtual Router ID

Syntax [no] vrid <VRID>

Context [VRRP Instance Configuration](#) context

Usage Set the virtual router identifier (VRID) used for the VRRP instance. The VRID must be unique per switch.

A virtual router identifier is a mandatory setting (**"no vrid"** is an invalid setting).

Use **"show vrid"** to show the configured virtual router ID (VRID) for this VRRP instance.

Default values None

32.3.4 Configure VRRP Version

Syntax [no] version <2|3>

Context [VRRP Instance Configuration](#) context

Usage Configure VRRP version to be used.

Use **"no version"** to return to the default version setting.

Use **"show version"** to show the configured version (2 or 3) for this VRRP instance.

Default values 2

32.3.5 Configure Virtual Address

Syntax [no] address <ADDRESS>

Context [VRRP Instance Configuration](#) context

Usage Set the virtual IP address (VIP address) used for the VRRP instance.

The VIP address should be within the same IP subnet as the regular IP address assigned to the interface (see [section 22.6.3](#)).

Only one VIP address can be configured per VRRP instance.

Use **"show address"** to show the configured virtual IP (VIP) address for this VRRP instance.

Default values Disabled

32.3.6 Configure VRRP Advertisement Interval

Syntax [no] interval <1..MAX> | <100..MAX*1000> msec

Context [VRRP Instance Configuration](#) context

Usage Configure VRRP advertisement interval in seconds or milliseconds. MAX (in syntax description) is depending on version and is 255 for version 2 and 40 for version 3.

For version 2 the allowed interval is <1..255> seconds and for version 3 the allowed interval is <0.1..40> seconds. To configure an interval that is a fraction of a second one must set the interval in milliseconds.

A small value enables faster fail-over.

Use **"no interval"** to return to the default interval setting.

Use **"show interval"** to show the configured advertisement interval for this VRRP instance.

Default values 1 (second)

Example In this example, the interval is set to 500 milliseconds. The setting is only valid for VRRP version 3.

```
 Example  
example:/config/#> router  
example:/config/router/#> vrrp 33  
example:/config/router/vrrp-33/#> interval 500 msec  
example:/config/router/vrrp-33/#> leave  
example:/#> copy running start
```

32.3.7 Configure VRRP Priority

Syntax [no] priority <1..255>

Context [VRRP Instance Configuration](#) context

Usage Configure VRRP priority. A high value increases the chance to become master of the VIP address (see also the "**preempt**" command in [section 32.3.8](#)).

Priority "255" should be used if (and only if) this router is the *owner* of the IP address used as VIP address, i.e., if the VIP address is assigned as an IP address to this router's interface (see [section 22.6.3](#)).

Use "**no priority**" to return to the default priority setting.

Use "**show priority**" to show the configured VRRP priority for this VRRP instance.

Default values 100

32.3.8 Enable or Disable VRRP Master Preemption

Syntax [no] preempt [delay <0..1000>]

Context [VRRP Instance Configuration](#) context

Usage Enable or disable VRRP master preemption. If enabled, this router will preempt an existing master if the current master has lower priority. (Note: The *owner* of a VIP address will always take over as master irrespective of the "**preempt**" setting.)

When preemption is enabled, the router will wait a time interval depending on the configured advertisement interval and a configurable preemption delay (seconds) before taking over as master.

**Note**

Preemption only occurs when starting or restarting a higher priority backup router, e.g. if a link down event occurs preemption will not be used.

**Note**

Note: When the instance belongs to a synchronized group, the instance with the shortest preemption delay will be used.

Use **"no preempt"** to prohibit this router to preempt an existing VRRP master.

Use **"show preempt"** to show the configured VRRP master preemption setting for this VRRP instance.

Default values Disabled (**"no preempt"**) When enabled, the delay defaults to 0 seconds.

32.3.9 Configure VRRP Message Authentication

Syntax [no] auth <plain> <SECRET>

Context [VRRP Instance Configuration](#) context

Usage Configure VRRP message authentication. Simple clear-text authentication is supported for VRRP version 2.

The associated secret can be 4-7 characters. Valid characters are ASCII characters 33-126, except '#' (ASCII 35).

Authentication is not available in VRRP version 3. Authentication will automatically be disabled if version 3 is configured. Use **"no auth"** to disable VRRP message authentication.

Use **"show auth"** to show the configured VRRP message authentication setting for this VRRP instance.

Default values Disabled

32.3.10 Configure VRRP Dynamic Priority

Syntax [no] track trigger <ID> adjust <DELTA>

Context [VRRP Instance Configuration](#) context

Usage Configure dynamic VRRP priority. The VRRP priority will be adjusted by the given delta value (-255 to 255) when the associated trigger reports "alarm" status. E.g., "**track trigger 2 adjust -100**" will decrease the VRRP priority by 100 when there is an alarm condition on trigger 2.

When a router is the owner of the VIP, i.e. configured with priority "255", the dynamic priority has no effect.

Use "**no track**" to remove (all) track entries defined for this VRRP instance. (As of WeOS v4.33.0, at most one "**track**" entry can be configured.)

Use "**show track**" to show the configured VRRP track entries, i.e., the dynamic VRRP priority setting.

Default values Disabled

Example In this example, this virtual router's priority is lowered from 150 to 50, if the router cannot reach the host 192.168.3.11 through the (upstream) interface *vlan2*.

Example

```
example:/config/#> alarm
example:/config/alarm/#> trigger ping
example:/config/alarm/trigger-2/#> peer 192.168.3.11 outbound vlan2
example:/config/alarm/trigger-2/#> end
example:/config/alarm/#> end
example:/config/#> router
example:/config/router/#> vrrp 33
example:/config/router/vrrp-33/#> address 192.168.2.1
example:/config/router/vrrp-33/#> priority 150
example:/config/router/vrrp-33/#> track trigger 2 adjust -100
example:/config/router/vrrp-33/#> leave
example:/#> copy running start
```

32.3.11 Configure VRRP Synchronisation

Syntax [no] sync <VRRP ID>

Context [VRRP Instance Configuration](#) context

Usage Configure synchronization between two VRRP instances. This will specify a state monitoring between two VRRP instances. It guarantees that two VRRP instances remain in the same state. The synchronized instances monitor each other. Changing this parameter will change the same parameter on the corresponding instance.

Use **"no sync"** to remove synchronization for this instance, this will remove synchronization for the corresponding instance as well.

Use **"show sync"** to show the configured VRRP instance ID this instance is synchronized with.

Default values Disabled

Example In this example, virtual router instance 33 is synchronized with instance 35.

Example

```
example:/config/#> router
example:/config/router/#> vrrp 33
example:/config/router/vrrp-33/#> sync 35
example:/config/router/vrrp-33/#> leave
example:/#> copy running start
```

32.3.12 Configure VRRP Multicast Routing Control

Syntax [no] mroute-ctrl

Context [VRRP Instance Configuration](#) context

Usage Configure whether multicast traffic should be routed on a interface in BACKUP state. If enabled, muticast traffic will not be routed when VRRP is in BACKUP state.

Use **"no mroute-ctrl"** to remove multicast routing control for this instance.

Use **"show mroute-ctrl"** to show the configured VRRP multicast routing control setting for this instance.

Default values Disabled

32.3.13 Show VRRP Status

Syntax show vrrp

Context [Admin](#) [Exec](#) context

Usage Show the status of all configured VRRP instances.

Default values Not applicable

Chapter 33

Firewall Management

When connecting your network to the Internet (or any non-trusted network) a router with firewall functionality should be used. The firewall will protect against undesired access to your local servers, or other kinds of network intrusion from attackers on the Internet.

The WeOS firewall supports the following main features:

- *Packet filtering*: Packet filters enables you to control what traffic is allowed to pass through your router/firewall and what packets it should drop. Packet filter rules can also be specified to control access to services on your router.
- *Packet modification*: Packet modification makes it possible to modify packets that are routed through the router/firewall.
- *Network Address Translation (NAT)*: The WeOS NAT functionality includes both *network address port translation (NAPT)* and *1-TO-1 NAT*.
- *Port forwarding*: Port forwarding is often used together with NAPT, and will then enable you to access servers in your private network from outside (e.g., from the Internet).

The WeOS firewall utilises *connection tracking*; a rule allowing traffic to pass through the firewall in one direction, will implicitly allow traffic of *established* connections (and traffic of *related* connections) to also pass in the reverse direction. Application level gateway (ALG) helper functions can be enabled to provide connection tracking of more complex protocols, such as FTP and SIP.

[Section 33.1](#) describes the firewall functionality available in WeOS. [Sections 33.2](#) and [33.3](#) cover firewall management via the Web Interface and via the CLI.

33.1 Overview

Table 33.1 summarises the supported firewall functionality. Sections 33.1.1-33.1.6 provide further information on the WeOS firewall support.

Feature	Web	CLI	General Description
Enable Firewall	X	X	Sections 33.1.1-33.1.2
Packet filtering			Sections 33.1.1-33.1.2
Enable Packet Filtering	X	X	Sections 33.1.1-33.1.2
Filtering Rules	X	X	Sections 33.1.1-33.1.2
Rule Reordering	X	X	Sections 33.1.1-33.1.2
Activate/Deactivate Rules	X	X	Sections 33.1.1-33.1.2
Default Forward Policy	X	X	Sections 33.1.1-33.1.2
Default Input Policy		X	Sections 33.1.1-33.1.2
Stateful Packet Inspection		X	Sections 33.1.1-33.1.2
DPI Filters (Modbus TCP)	X	X	Sections 33.1.1, 33.1.3
Packet modification			Sections 33.1.1, 33.1.4
DSCP	X	X	Section 33.1.4.3
Network Address Translation			
NAPT	X	X	Sections 33.1.1, 33.1.5
1-TO-1 NAT	X	X	Sections 33.1.1, 33.1.5
Port Forwarding	X	X	Sections 33.1.1, 33.1.6
ALG Helpers	X	X	Section 33.1.1
Logging	X	X	Section 33.1.7
View Firewall Configuration	X	X	
View Firewall Status		X	

Table 33.1: Summary of Firewall functionality in WeOS

33.1.1 Firewall introduction

The WeOS firewall includes support for three related types of functionality:

- *Packet Filtering*: The packet filtering support is primarily used to control what traffic is allowed to be *routed* via the switch (forward filtering), but can also be used to control accessibility to services on the switch itself (input filtering).

The WeOS firewall utilises *connection tracking*; a filter rule allowing traffic

to pass through the firewall in one direction, will implicitly allow traffic of *established* connections (and traffic of *related* connections) to also pass in the reverse direction. Connection tracking can be configured to handle more complex protocols by enabling ALG helpers (see below).

WeOS supports up to 1024 filtering rules. The WeOS packet filtering support is further described in [sections 33.1.2](#) and [33.1.2.3](#).

- *Packet modification:* WeOS currently supports one kind of packet modification:
 - *DSCP:* The Differentiated Services Code Point (DSCP) field of the IP header is used for classifying traffic in some environments. The value of this field can be modified by WeOS *when routing* the IP packets.

WeOS supports up to 32 packet modifier rules. The WeOS packet modification support is further described in [section 33.1.4](#).

- *Network Address Translation (NAT):* WeOS supports two kinds of NAT support:
 - *NAPT:* NAPT is the most common NAT form, where a common (public) IP address is shared by a set of hosts in a *private* network. This form of NAT is sometimes referred to as IP Masquerading or port address translation (PAT). NAPT is often used together with *port forwarding*, see below.
 - *1-TO-1 NAT:* 1-TO-1 NAT enables you to translate a whole range of IP addresses to another set of addresses.

WeOS supports up to 512 NAT rules. The WeOS NAT support is further described in [section 33.1.5](#).

- *Port Forwarding:* Port forwarding is commonly used together with NAPT. With port forwarding a service (such as a Web Server) located in a *private* network, can be made accessible from the *public* network, typically from the Internet.

WeOS supports up to 256 port forwarding rules. The WeOS port forwarding support is further described in [section 33.1.6](#).

Some network protocols are more complex and therefore more difficult than others to handle by the connection tracking function in a firewall or NAT device. An example is FTP, which utilises a *control connection* to exchange information on TCP port numbers for *data connections* for the actual file transfers – to enable a PC to download files through a firewall from an FTP server on the Internet, the firewall must inspect the FTP control connection to learn which connections to let

through. To make the firewall handle such protocols correctly, protocol specific ALG helpers can be enabled. As of WeOS v4.33.0 ALG helpers for FTP, TFTP, SIP, IRC, H323 and PPTP are supported. ALG helpers have some impact on the unit's routing performance, thus are by default disabled.

33.1.2 Packet Filtering

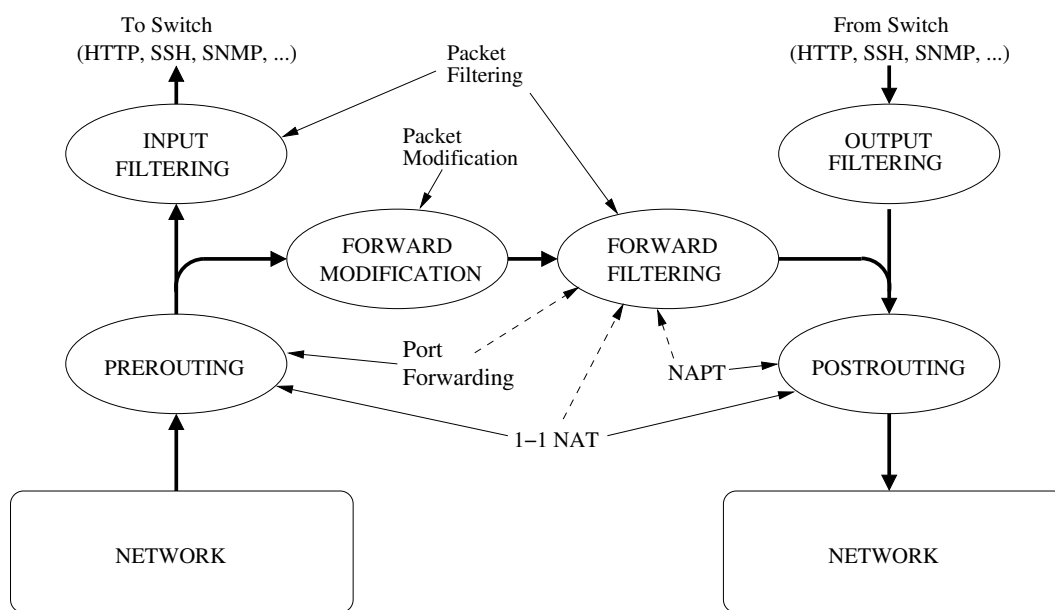

Figure 33.1: Overview of Firewall mechanism. Thick lines represent packet flows.

Fig. 33.1 presents an overview of the firewall mechanism, including the components for *packet filtering*, *packet modification*, *NAT*, and *port forwarding*.

The following sections provide a more in-depth description of the WeOS *packet filtering* functions.

- *Filtering chains (input, forward, output)*: Filter rules can apply to
 - traffic destined to the switch (*input filtering*), e.g., HTTP traffic to manage the switch,
 - traffic forwarded/routed by the switch (*forward filtering*), or
 - traffic generated by the switch (*output filtering*).

The WeOS firewall supports *input* and *forward* filtering, but not *output* filtering. Section 33.1.2.1 gives more details on WeOS handling of filtering

chains.

- *Configurable allow/deny filter rules:* The user can define filter rules to specify traffic to be *allowed* or *denied*, and the order of the configured rules. Incoming packets are evaluated against the filter rules – the first matching rule will decide how to treat the packet (*allow* or *deny*). [Section 33.1.2.2](#) describes packet matching parameters for filter rules, and [section 33.1.2.3](#) provides more information on filter evaluation order (both for *configured* filter rules and *implicit* filter rules described below).

Default rules to allow "ping"

When enabling the firewall, the user is offered to add a set of *default rules* - these rules allow ICMP packet to pass the *input filter*, thereby enabling operators to *ping* the unit after enabling the firewall. These rules are treated as any other configured rule, thus can be removed, etc.

- *Implicit filter rules:* The WeOS firewall implicitly adds firewall rules for services enabled on the unit, e.g., for DHCP, OSPF or DNS. The primary purpose of this is to simplify management of those services when the firewall is enabled. With a few exceptions, these *implicit rules* are evaluated **after** the *configured rules* (see above), thus, a user could override or complement the implicit rules by configuring additional filter rules. Below is a list of services associated with implicit filter rules.

- IPsec VPN:

- * *IPsec signalling and data encapsulation:* If at least one IPsec tunnel is enabled, rules are implicitly added to allow IP protocol 50 (ESP), and UDP port 4500 (IKE/ESP for NAT traversal) to enter the unit on all interfaces.
- * *Allowing data to pass through tunnels:* For every IPsec VPN tunnel (see [chapter 37](#)) filter rules are implicitly added to the forward filter to *allow* between the *local subnet* and *remote subnet* defined for the VPN tunnel.

As of WeOS v4.33.0, the implicit IPsec VPN rules are added **below** the configured filter rules. In previous releases they were added before. Now implicit IPsec VPN rules can be overridden by rules configured by the user.

- *Port Forwarding*: With port forwarding ([section 33.1.6](#)) it is possible to map incoming data to a given destination IP and (UDP/TCP) port to another destination IP/port when forwarding the packet. As shown in [fig. 33.1](#) this mapping is conducted at the *pre-routing* stage of the packet processing. For every configured port forwarding rule, a filter rule is implicitly added to the forwarding filter to allow the packet to pass through the router. This is hinted by a *dashed arrow* in [fig. 33.1](#).
- *NAT*: Network address translation ([section 33.1.5](#)) involves "translation operations" both in the pre-routing ("1-TO-1 NAT") and in the post-routing stage ("1-TO-1 NAT" and "NAPT") as shown in [fig. 33.1](#). For every configured NAT rule, an associated filter rule **can** be added to the forwarding filter to allow the packet to pass through the router. This is hinted by a *dashed arrow* in [fig. 33.1](#).

**Note**

The user can choose if an associated filter rule should be added for each NAT rule or not. If disabled, the user needs to configure own filter rule(s) to make the data packets pass through the firewall. See [sections 33.1.5.1](#) and [33.1.5.2.3](#) for more information.

- *Services*: Filter rules are implicitly added to to the *input filter* to allow packets for enabled services to enter the unit. This includes configurable services such as DHCP Server ([chapter 23](#)), Serial Over IP ([chapter 41](#)), VRRP ([chapter 32](#)), etc., where allow rules are added matching TCP/UDP port numbers, IP protocols, and/or incoming interfaces appropriate for the configured services. As the WeOS unit acts as a DNS forwarder, implicit allow rules to accept incoming DNS requests are also added.

TTDP is a protocol for train routers([chapter 44](#)). TTDP will implicitly add (hidden) 1-1 NAT rules and matching (hidden) filter rules to the *forward filter* to allow the NAT:ed traffic to pass.
- *Management interface*: The WeOS management interface feature ([section 22.2.7](#)) utilises firewall functionality to control which network interfaces the unit can be managed through.
- *Other filter rules*:
 - *Connection tracking (related/established)*: The WeOS firewall will allow all packets associated with established connections, as well as packets

related to established connections. This means that an a rule allowing traffic to pass through the firewall in one direction, will implicitly allow traffic of *established* connections (and traffic of *related* connections) to also pass in the reverse direction. Application level gateway (ALG) helper functions can be enabled to provide connection tracking of more complex protocols, such as FTP and SIP.

For performance reasons, packets of related/established connections are evaluated early in the filter chains, thus cannot be overridden by filter rules configured by the user.

- *Stateful Packet Inspection (ability to drop packet of invalid state)*: It is also possible to fine-tune the connection tracking behaviour to *drop* packets of *invalid*¹ state – this is done by enabling the *stateful packet inspection* (SPI) setting. In some situations that can be considered as a security enhancement, however, it may cause problems in topologies with asymmetric routing and is therefore disabled by default.
- *Default filter rules*: Packets not matching any filter rule will be handled according to the default filter policy. The default filter policy for the *input filter* and *forwarding filter* chains are configurable, see [section 33.1.2.1](#).

33.1.2.1 Filtering chains (input, forward, output)

[Fig. 33.1](#) presents an overview of the firewall mechanism including the filtering chains (input, forward and output). Packets are treated differently if they:

- *are destined to the switch*: Examples include HTTP/HTTPS, SSH, Telnet, and SNMP traffic used to manage the switch remotely, and ICMP (Ping) traffic to check if the switch is up or not. Such packets are subject to *pre-routing* and *input filtering* firewall mechanisms.
- *originate from switch*: This includes the same examples as above (HTTP/HTTPS, SSH, Telnet, SNMP, ICMP, etc.) with the difference that this is the packets from the switch instead of the packets to the switch. Such packets are subject to *output filtering* and *post-routing* firewall mechanisms, however WeOS does **not** include primitives to control *output filtering*.
- *are routed via the switch*: This includes traffic that is not destined for the switch or originate from the switch. Such packets are subject to *pre-routing*, *forward filtering* and *post-routing* firewall mechanisms.

¹An example of a packet with an "invalid" state is when a firewall sees a TCP "SYN+ACK", without having seen the preceding TCP "SYN" in the other direction.

As of WeOS v4.33.0, the selection of filter chain for configured filter rules is implicitly derived from the "outbound interface" and "destination IP Address/subnet" settings (see [section 33.1.2.2](#)) for the rule:

- *Apply rule to forwarding filter:* If "outbound interface" **and/or** "destination IP Address/subnet" are specified in the filter rule, it will apply to the "Forwarding Filter" chain.
- *Apply rule to input filter:* If **neither** "outbound interface" **nor** "destination IP Address/subnet" are specified, the filter rule will apply to the "Input Filter" chain.

WeOS does not support adding filter rules for the "Output Filter" chain.

Associated with each filtering chain there is a default policy, defining what to do with packets that do not match any of the defined filter rules. When the firewall is enabled, the *default policies* for packet filtering are as follows:

- *Input Filtering:* **Deny**, i.e., packets to the switch are dropped unless they are explicitly allowed.
- *Forward Filtering:* **Deny**, i.e., when enabling the firewall no packets will be routed by the switch until such packet filter rules are defined.
- *Output Filtering:* **Accept**, i.e., there are no restrictions on the traffic originating from the switch.

33.1.2.2 Filter Rules Packet Matching

Packet filtering *allow* and *deny* rules can be specified to *match* IP packets based on the following filtering parameters:

- *Inbound Interface:* The interface where the packet comes in.
- *Outbound Interface:* The interface where the packet is sent out.
- *Source IP Address/Subnet:* The source IP address of the packet. This can be specified as a single IP address, or the rule could match a whole IP subnet.
- *Destination IP Address/Subnet:* The destination IP address of the packet. This can be specified as a single IP address, or the rule could match a whole IP subnet.
- *Protocol:* The *protocol* type of the IP payload. Typically TCP or UDP, but the filtering can also be made to match other protocols such as ICMP and ESP².

²See <http://www.iana.org/assignments/protocol-numbers/> for a list of defined IP protocols.

- *Destination (UDP/TCP) Port*: When *protocol* is specified as UDP or TCP, the filter can match on the associated destination UDP/TCP port number(s).
- *Source (UDP/TCP) Port*: When *protocol* is specified as UDP or TCP, the filter can match on the associated source UDP/TCP port number(s).

As described in [section 33.1.2.1](#) the filter setting for "outbound interface" and "destination IP Address/subnet" implicitly controls whether the rule will apply to the *input filter* or *forwarding filter*.

An incoming packet will be processed according to the *rules* defined for *input filter* when the packet is destined to the switch, or the rules defined for the *forwarding filter* when the packet is being routed through the switch. The list of rules is searched (in order) until a match is found; if no matching rule is found, the packet is treated according default policy of the chain.

For more information on the rule evaluation order in the input filter and forward filter, see [section 33.1.2.3](#).

33.1.2.3 Rule Evaluation Order in Input and Forward Filters

When the firewall is enabled, incoming packets are subject to *input filtering* or *forward filtering* depending if the packet is destined to the switch itself, or if it should be routed to another network. Once the packet has been classified for the input or output filter chain, the list of that chain is traversed to find a matching rule. If a match is found, the packet will either be accepted or dropped depending on the type of matching rule (allow or deny). If no matching rule is found, the packet will be handled according to the default policy of the chain.

The filter rules are inserted in the list in a certain order; the same order as the packet matching evaluation is conducted. To view the current input and forward filter evaluation lists, use the command "**show firewall**" (see [section 33.3.14](#)) from the *Admin Exec* context. The order in which rules are inserted in the input and forward filters is described below.

33.1.2.3.1 Input Filter

1. *Established/Related*: Packets part of (or related) to established connections will be accepted. This rule is inserted first for performance reasons - the majority of all accepted packets will match this rule.
2. *Drop invalid*: If the stateful packet inspection (SPI) setting has been enabled, packets of invalid state will be dropped. (See [section 33.1.2](#) for more information on what the SPI setting does.)
3. *VPN Rules*: If the WeOS unit is configured as VPN gateway, rules to accept IKE and ESP traffic are implicitly inserted here (UDP port 500 and 4500, and IP protocol 50).
4. *Configured Packet Filter Rules*: Then the configured packet filter rules are inserted, i.e., the configurable allow/deny rules described here in [section 33.1.2](#). The *relative* order of these packet filter rules is configurable.

As all packet rules are configured before the rules for "Enabled Services" and "Management Interfaces" (see below), the packet filter rules can be used to *override* those rules. E.g., if the *management interface configuration* has disabled SNMP management via interface *vlan1* ("**no management snmp**", see [section 22.6.6](#)), a packet filtering rule allowing host *192.168.3.1* SNMP access ("**filter allow src 192.168.3.1 proto udp dport 161**", see [section 33.3.3](#)) will have precedence, and thus allow SNMP management from that particular host even if the SNMP traffic enters via interface *vlan1*.

5. *Enabled Services*: Depending on what additional services are enabled in the configuration, additional allow rules will be inserted to enable those services to operate correctly. As of WeOS v4.33.0, this includes
 - DHCP Server: UDP port 67 is allowed for appropriate interfaces if a DHCP server is configured (see [chapter 23](#)).
 - OSPF: IP protocol 89 is allowed if the unit is configured to run OSPF for dynamic routing (see [chapter 29](#)).
 - RIP: UDP port 520 is allowed if the unit is configured to run RIP for dynamic routing (see [chapter 30](#)).
 - VRRP: IP protocol 112 is allowed for appropriate interfaces if VRRP is configured on the unit (see [chapter 32](#)).
 - Serial Over IP: If Serial Over IP is configured (Server, Peer or AT command mode), an allow rule according to the configured (UDP/TCP) port

and interface is added (see [chapter 41](#)).

- Modbus: If the unit is configured as a Modbus gateway (server mode), an allow rule according to the configured TCP port and interface is added (see [chapter 42](#)).
- DNS: UDP/TCP port 53 is allowed on all interfaces as the WeOS unit acts as a DNS forwarder.

6. *Enabled Management Interfaces*: As described in [section 22.2.7](#), an operator can use the *Management Interface* feature to enable/disable services per network interface. The management interface configuration is kept separate from the firewall configuration, but both configuration methods can affect the *Input Filter*. Allow rules for enabled management services are added per interface³.

- SSH: TCP port 22 is opened for interfaces where management via SSH has been enabled. (This also enables use of SCP for remote file access, see [section 7.1.5.3](#)).
- Telnet: TCP port 23 is opened for interfaces where management via Telnet has been enabled.
- HTTP: TCP port 80 is opened for interfaces where management via HTTP has been enabled.
- HTTPS: TCP port 443 is opened for interfaces where management via HTTPS has been enabled.
- SNMP: UDP port 161 is opened for interfaces where management via SNMP has been enabled.
- (IPConfig:) If management via IPConfig service has been enabled, no corresponding allow rule is required - IPConfig protocol packets are instead filtered by other (lower-level) mechanisms in WeOS.

7. *Default Policy*: Packets not matching any of the rules above will be handled according the default policy for the input filter chain.

³As of WeOS v4.33.0 "allow" rules for *enabled* management services are added given that the "Default policy" for the input filter is set to "deny". If the default policy is changed to "allow", then "deny" rules for *disabled* management interfaces will be inserted instead.

33.1.2.3.2 Forwarding Filter

1. *Packet modification*: Defined packet modifications are always performed before all filter rules, implicit and configured. Please see [section 33.1.4](#) for additional details.
2. *DPI Rules*: Configured (Modbus) DPI rules ([section 33.1.3](#)) are evaluated first of the forwarding filters. Thus, DPI rules implies a performance penalty.
3. *Established/Related*: Packets part of (or related) to established connections will be accepted. This rule is put first of the forwarding filters for performance reasons (assuming no DPI rules are defined.) The majority of all accepted packets will match this rule.
4. *Drop invalid*: If the stateful packet inspection (SPI) setting has been enabled, packets of invalid state will be dropped. (See [section 33.1.2](#) for more information on what the SPI setting does.)
5. *VPN Rules*: If the WeOS unit is configured as VPN gateway, rules to accept traffic between the local and remote subnets specified in the respective IPsec tunnel definitions are added to the forward filter. The reason for adding the implicit IPsec allow filter rules early in the evaluation order is to improve routing performance of VPN traffic. (In case you wish to limit the traffic to pass through the IPsec tunnel further, the recommendation is to update the IPsec tunnel definitions of local and remote subnet accordingly, see [section 37.1.1](#).)
6. *Configured Packet Filter Rules*: Then the configured packet filter rules are inserted, i.e., the configurable allow/deny rules described here in [section 33.1.2](#). The *relative* order of these packet filter rules is configurable.
7. *NAT and Port Forwarding Rules*: As described in [section 33.1.2](#) implicit allow filter rules are added for every configured port forwarding rule.

This is also true for NAT rules, however, here the user can choose whether the associated rule should be created or not (see [sections 33.1.5.1](#) and [33.1.5.2.3](#)). The internal order of the NAT rules can be changed, which also affects the order in which the associated filter rules are inserted in the forwarding filter chain.
8. *Enabled Services (TTDP)*: If TTDP is enabled ([chapter 44](#)), implicit (hidden) filter rules will be added to allow the "railway NAT" traffic to pass.
9. *Default Policy*: Packets not matching any of the rules above will be handled according the default policy for the forwarding filter chain.

33.1.3 DPI filtering

Deep Packet Inspection (DPI) rules work similar to regular Packet Filter rules, but look further into the payload when deciding what packets to allow or drop. At the moment only *Modbus TCP* DPI rules are supported, enabling filter matching on *Modbus function code*, *unit ID* and *register address*, in addition to the matching settings available for regular packet filter rules (see [section 33.1.2](#)).

33.1.3.1 Differences to standard filter rules

Below differences between DPI and regular filter rules are listed.

- *Allow rules only (whitelisting)*: Current DPI rules are limited to *allow* rules. *DPI deny* rules cannot be configured. Instead, an extra deny rule is *implicitly* added after the Modbus allow rules, blocking all other Modbus traffic. Users only need to add rules for all Modbus TCP packets allowed to pass. This is known as a whitelist strategy.
- *Forward chain only*: DPI rules are only allowed in the Forward chain. This means packets coming in on one interface and going out on another interface. Specify either an *out interface* or/and a *destination address* to automatically place the rule in the Forward chain.
- *TCP only*: Modbus TCP also requires protocol to be set to TCP and a destination port to be given (default 502).

The following example allows Modbus packets with function code 1-4 to pass from hosts 10.0.3.1 and 10.0.3.7. It also shows the implicit rules added after the accept rules, i.e., the *drop* rule for other Modbus traffic, and accept rules for connection establishment to the Modbus TCP port (one per DPI rule).

 **Example**

```

example:/#> configure
example:/config/#> ip
example:/config/ip/#> firewall
example:/config/ip/firewall/#> dpi allow out vlan2 src 10.0.3.1 dst 10.0.4.5 proto tcp dport 502 modbus function 1-4
example:/config/ip/firewall/#> dpi allow out vian2 src 10.0.3.8 dst 10.0.4.5 proto tcp dport 502 modbus function 1-4
example:/config/ip/firewall/#> leave
example:/#> show firewall
...
=== Forwarding Packet Filter Rules =====
Forwarding Policy DROP
target  prot in    out    source      destination      tcp dpt:modbus modbus fc 1:4  <== Configured
ACCEPT  tcp  any  vlan2  10.0.3.1     10.0.4.5         tcp dpt:modbus modbus fc 1:4  <==
ACCEPT  tcp  any  vlan2  10.0.3.8     10.0.4.5         tcp dpt:modbus modbus fc 1:4  <==
DROP    tcp  any  any     anywhere     anywhere         tcp dpt:modbus modbus         <== Implicit
ACCEPT  tcp  any  vlan2  10.0.3.1     10.0.4.5         tcp dpt:modbus state NEW     <==
ACCEPT  tcp  any  vlan2  10.0.3.8     10.0.4.5         tcp dpt:modbus state NEW     <==
...
example:/#>

```

33.1.3.2 Modbus TCP specific DPI parameters

Three types of Modbus parameters are available for Modbus DPI rules, all optional.

- *Function Code*: DPI can filter on Modbus *function codes*. A list of code can be specified.
- *Unit ID*: DPI can filter on Modbus *unit ID*. More than one Modbus device may sit behind the same IP address, use this parameter to specify a single device.
- *Register addresses*: DPI can filter on Modbus *register addresses*. Note that the meaning of this filter varies depending on the function code. *Coils*, *input registers* and *holding registers* have individual register address ranges.

33.1.3.3 Zero-based addressing

Zero-based addressing (or zero-mode) means that register addresses will start at 0 (zero). This how register addresses are encoded in the Modbus packets, and is also how WeOS applies the DPI filter.

Some Modbus PLC devices use zero-mode while others do not; instead they start counting register addresses at 1. When configuring DPI rules to filter traffic for a PLC starting counting at 1, the WeOS DPI filter needs to be set *off-by-one* compared to the PLC setting. For instance, if PLC holding register 5 should be read, then register 4 should be allowed through the firewall, as the number 4 will be in the network packet.



Hint

Check the actual register address in the network packet by capturing and inspecting Modbus network traffic using Wireshark^a or other network capture tools. That way you can see if the Modbus device is using zero-based addressing or not.

^a<https://www.wireshark.org>, accessed August 2023

33.1.3.4 Read-only use case

The most common Modbus *read* functions are numbered 1 to 4, and the most common *write* functions are numbered 5 to 16. A common use case is to only allow read functions and drop all other Modbus packets (including all modbus write

functions). To achieve this only one rule has to be created that allows Modbus functions 1-4. If needed, also specify unit ID and optionally a register range. All this can be set in the same rule as long as all ranges are consecutive. Note that coils, input registers and holding registers have individual register ranges if you use the register filter.

33.1.4 Packet modification

WeOS supports modification of packets that are *routed* through the router/firewall. In the firewall overview, [fig. 33.1](#) in [section 33.1.2](#), you can see that the modification is performed just before the forward filtering. Current limitations are that you can only modify the DSCP field of the IP header, and that modification is only possible for *forwarded* traffic, not for inbound or outbound local traffic.

Packet modification is specified as rules, similar to filters, and they are evaluated in the same order as they are listed. Opposite to filters ([section 33.1.2](#)), packet modification rules are non-terminating. This means that every rule will be evaluated for packets passing through, and packets may be modified more than once on its way through the modifier step.

33.1.4.1 Performance considerations

The *packet filtering* mechanism utilises the connection tracking mechanism to optimise handling for already established sessions, while *packet modification* rules can not use this connection tracking benefit. The modification rules will be evaluated for *every single forwarded packet* passing the router/firewall, which means that modification rules have a much *bigger performance impact* than filtering rules.

As using modifier rules decreases the total routing throughput of the router/firewall, you should use this feature with care and avoid adding unnecessary rules.

33.1.4.2 Packet modification matching

Much like packet filters, modification rules can have *match* parameters defining what traffic the rules apply to. The matching parameters are optional – if skipped the modifier rule runs for *ALL* packets.

These are the matching parameters that can be used:

- *Inbound Interface*: The interface where the packet comes in.
- *Outbound Interface*: The interface where the packet is sent out.

- *Source IP Address/Subnet*: The source IP address of the packet. This can be specified as a single IP address, or the rule could match a whole IP subnet.
- *Destination IP Address/Subnet*: The destination IP address of the packet. This can be specified as a single IP address, or the rule could match a whole IP subnet.
- *Protocol*: The *protocol* type of the IP payload. Typically TCP or UDP, but the filtering can also be made to match other protocols such as ICMP and ESP⁴.
- *Destination (UDP/TCP) Port*: When *protocol* is specified as UDP or TCP, the filter can match on the associated destination UDP/TCP port number(s).
- *Source (UDP/TCP) Port*: When *protocol* is specified as UDP or TCP, the filter can match on the associated source UDP/TCP port number(s).

33.1.4.3 Modification of the DSCP field

33.1.4.3.1 DSCP Introduction

DSCP, Differentiated Services Code Point (or Diffserv Code Point), is a standardised method for marking IP packets that they belong to a specific class of traffic. Its use in the IP header is specified in RFC 2474[36].

Octet 0	Octet 1	Octet 2	Octet 3	Octet 4	Octet 5	Octet 6	Octet 7	
Version	IHL	Type of Service	Total Length		Identification		Flags	Fragment Offset
Octet 8	Octet 9	Octet 10	Octet 11	Octet 12	Octet 13	Octet 14	Octet 15	
Time to Live	Protocol	Header Checksum			Source Address			
Octet 16	Octet 17	Octet 18	Octet 19	Octet 20	Octet	
Destination Address				Options, padding, payload data ...				

Figure 33.2: The IPv4 header

For the IPv4 header (RFC 791[39]), the "Type of service" (or ToS) octet on offset 1 is used for carrying this kind of data. See fig. 33.2.

The IPv4 ToS octet has historically been used in different ways.

0	1	2	3	4	5	6	7
Precedence			D	T	R	M	0

Figure 33.3: ToS bits according to RFC 791 + RFC 1349

⁴See <http://www.iana.org/assignments/protocol-numbers/> for a list of defined IP protocols.

The original definition of ToS in RFC 791 has 3 precedence bits, and bits 3-5 as flags for "cost" aspects: "Delay", "Throughput" and "Reliability". RFC 1349[2] updated ToS by adding the utilisation of bit 6 for "Monetary cost". See [fig. 33.3](#).

0	1	2	3	4	5	6	7
DSCP						ECN	

Figure 33.4: ToS bits according to RFC 2474 + RFC 3168

Later on, RFC 2474 redefined the use of the octet to carry DSCP information in the first 6 bits. RFC 2481[40] and its replacement RFC 3168[41] complement this by defining bits 6-7 for "Enhanced Congestion Notification" (ECN), see [fig. 33.4](#).

Both these conflicting interpretations are still in use today confusingly enough. The DSCP modification and the Layer-2 prioritising mechanisms ([section 10.1.4](#)) in WeOS are adapted to the RFC 2474 use.

33.1.4.3.2 Setting DSCP

WeOS can set the 6 DSCP bits in the IP ToS field with a modifier rule. The two last bits (Enhanced Congestion Notification) are not modified by this operation.

The decimal values 0-63 must be used when setting DSCP.

Several RFCs define standard DSCP values called "Per-Hop Behaviors" or PHBs. WeOS does not support the PHB names for configuration, but the table below can be used to convert PHB names to the corresponding decimal values.

PHB Name	DSCP value	PHB Name	DSCP value
DF	0	AF32	28
CS1	8	AF33	30
AF11	10	CS4	32
AF12	12	AF41	34
AF13	14	AF42	36
CS2	16	AF43	38
AF21	18	CS5	40
AF22	20	VA	44
AF23	22	EF	46
CS3	24	CS6	48
AF31	26	CS7	56

33.1.4.3.3 DSCP Adjust priority

There is an additional parameter called "adjust priority" that can be added to a DSCP modifier rule. This parameter enables adjustment of the router's internal packet priority handling inline with the modified DSCP value. Furthermore, if traffic is routed out on a port that has tagged VLAN, this will affect the IEEE 802.1p priority field in the outbound packets.

This is useful in some scenarios when the DSCP is overridden. The priority adjustment function is made to mimic the behaviour of the Layer-2 priority support when configured in the IP ToS/DiffServ mode, as described in [chapter 10, section 10.1.4](#).

Enabling this flag will introduce more work for the CPU inside the WeOS unit for every packet that is modified. As this decreases the maximum routing performance, it should only be enabled when necessary.

33.1.5 Network Address Translation

WeOS supports two kinds of NAT: NAPT and 1-to-1 NAT

33.1.5.1 NAPT style NAT

NAPT, or "Network Address and Port Translation" enables hosts on a private network to share an Internet connection with a single public IP address. NAPT is also known as IP Masquerading or PAT (Port Address Translation) in the Cisco world.

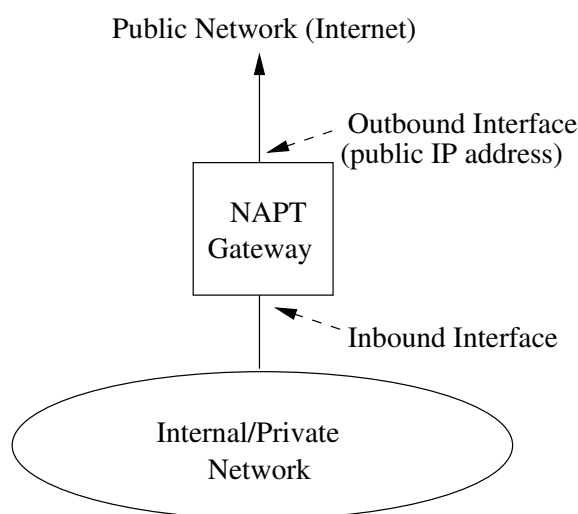

Figure 33.5: NAPT gateway providing access to the Internet. All hosts in the private network share a single public IP address.

When configuring a NAPT rule, you need to specify the *outbound interface*⁵. The appropriate rule will then be added to the *post-routing* step (see [fig. 33.1](#)) handling the address translation. A rule is also needed in the *forward filtering* chain to enable the forwarding (routing) of traffic, and that can be added automatically by using the "**addfilter**" option as shown in the example below (here we assume that the interface "Outbound/Public" side is named "vlan2").

Example

```
example:/config/ip/firewall/#> nat type napt out vlan2 addfilter
```

⁵Appropriate interface IP settings must be configured, and IP routing must also be enabled, see [chapter 22](#).

The resulting firewall allow rule is shown below:

Example

```
example:/#> show firewall
=== Forwarding Packet Filter Rules =====
Forwarding Policy DROP
target  prot in    out    source  destination
...
ACCEPT  all  any    vlan2  anywhere anywhere
...
```

Connection tracking will ensure that packets in the reverse direction (from the Internet to the private network) are accepted and managed properly.

33.1.5.2 1-to-1 style NAT

1-to-1 NAT, also called Full NAT, maps an entire network block in a one-to-one fashion.

33.1.5.2.1 Forward 1-to-1 NAT

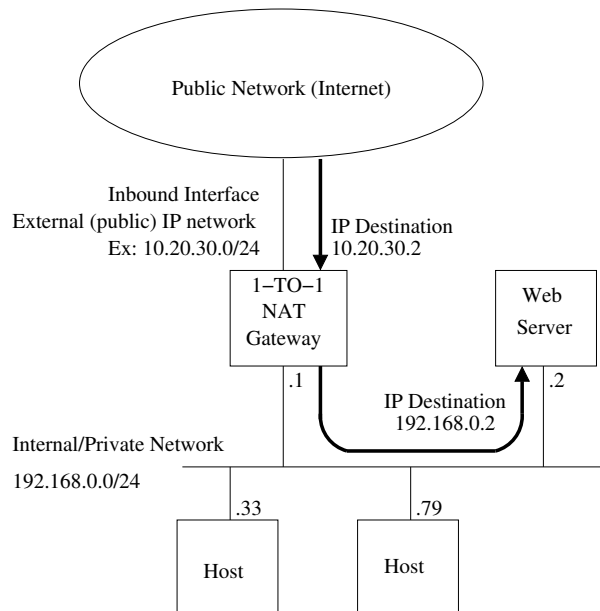

Figure 33.6: 1-to-1 NAT mapping external IP addresses to internal addresses.

A 1-to-1 NAT rule is defined by an inbound interface and two network blocks, the externally (publicly) visible network block and the internal block (typically private IP addresses). IP packets entering the router through the inbound interface targeted to the external network will be transformed so they become targeted to the internal block instead (see [fig. 33.6](#)). Packets going to the first IP in the external block will be mapped so they go to the first IP in the internal block, packets to the second external IP to the second internal IP, and so on. This one-to-one mapping requires that the external and internal network blocks are of the exact same size.

1-to-1 NAT mapping is done in the *pre-routing* step in the firewall (see [fig. 33.1](#)). This means (for inbound packets affected by a 1-to-1 NAT rule) that the destination IP address is changed to another IP address **before** routing is done and before rules in the *input filtering* and *forward filtering* chains are evaluated. Make sure that you only use the internal network block (called "new destination" in the web configuration and "to-dst" in CLI config) in routing and filtering as the external network is not visible inside the unit.

33.1.5.2.2 Reverse 1-to-1 NAT

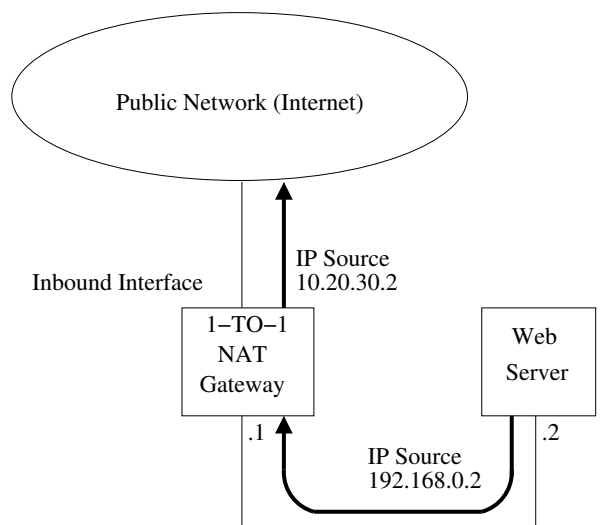

Figure 33.7: Reverse 1-to-1 NAT mapping

1-to-1 NAT is bi-directional which means that the NAT works in the reverse direction too. A request coming from an internal IP will be transformed so it appears to come from the external net when leaving the router through the configured "inbound" interface (see [fig. 33.7](#)).

In this case the translation of the IP source address will be performed in the *post-routing* chain (fig. 33.1), just before packets leave the router. This means that the original internal network IP will be matched as source in any *forward filtering* and *output filtering* rules. The external addresses will not be visible here similar to the forward direction NAT.

33.1.5.2.3 1-1 NAT and implicit firewall rules Consider the sample network setup shown in figs. 33.6 and 33.7. Assuming the "inbound" interface is named "vlan2", then the "1-to-1" NAT rule could be achieved with the following CLI command.

Example

```
# Example with implicit firewall rule
example:/config/ip/firewall/#> nat type 1-to-1 in vlan2 dst 10.20.30.0/24
to-dst 192.168.2.0/24 addfilter
```

The "**addfilter**" attribute will add implicit firewall rules to allow forward traffic (fig. 33.6) and reverse traffic (fig. 33.7) to automatically pass through the firewall. One rule is created in each direction, as shown below.

Example

```
example:/#> show firewall
...
=== Forwarding Packet Filter Rules =====
Forwarding Policy DROP
target  prot in    out    source      destination
...
ACCEPT  all  vlan2  any  anywhere    192.168.2.0/24
ACCEPT  all  any    vlan2  192.168.2.0/24  anywhere
...
```

Using the "addfilter" makes it easy to get your NAT-traffic through the firewall in either direction. But in cases where there are security concerns, such as when the "inbound" interface is located on the public Internet, use of the "**addfilter**" option for "1-to-1 NAT" is too permissive. Instead you could add explicit firewall rules to allow traffic according to your specific requirements. An example is shown below where traffic is only allowed to be *initiated* from the private network (i.e., the "reverse" direction as shown in fig. 33.7). Note that the "**nat**" command does not include the "**addfilter**" option here.

Example

```
# Example with explicit firewall rule instead of implicit

example:/config/ip/firewall/#> nat type 1-to-1 in vlan2 dst 10.20.30.0/24
to-dst 192.168.2.0/24
example:/config/ip/firewall/#> filter allow out vlan2 src 192.168.2.0/24
```

The resulting firewall rule is shown below.

Example

```
example:/#> show firewall
...
=== Forwarding Packet Filter Rules =====
Forwarding Policy DROP
target    prot in    out    source          destination
...
ACCEPT   all  any    vlan2  192.168.2.0/24  anywhere
...
```

33.1.5.2.4 Proxy ARP and 1-to-1 NAT

WeOS 1-to-1 NAT includes a *proxy ARP* mechanism, which makes the WeOS unit answer on ARP requests for the external network specified in the configuration (the **"dst"** parameter in the CLI or **Destination Address(es)** field in the Web interface). The router will only answer on ARP requests originating from the network connected to the inbound interface (CLI: **"in"** parameter, Web: **Incoming Interface**). This makes it possible to use 1-to-1 NAT to pick up traffic to a specific subnet from within a larger network without the need of explicit routing settings.

An example is shown in [fig. 33.8](#): You have a subnet 10.0.0.0/16 set on your external LAN, and want to use 1-to-1 NAT to take care of the specific subnets 10.0.1.0/24, 10.0.2.0/24 and 10.0.3.0/24, which should be translated and routed to the inside of the Router1, Router2 and Router3 respectively. In this case, hosts at the external LAN, such as the management PC (10.0.0.99), will use ARP when they want to reach something within the 10.0.0/16 range. If the PC sends an ARP Request for 10.0.1.33 (PLC3), WeOS Router1 will respond and announce its own MAC address in the ARP reply. Traffic from the management PC (and other hosts on the external network) to 10.0.1.33 (PLC3) will be sent to Router1, which performs 1-to-1 NAT (10.0.1.33⇒192.168.1.33) before forwarding the packets towards PLC3.

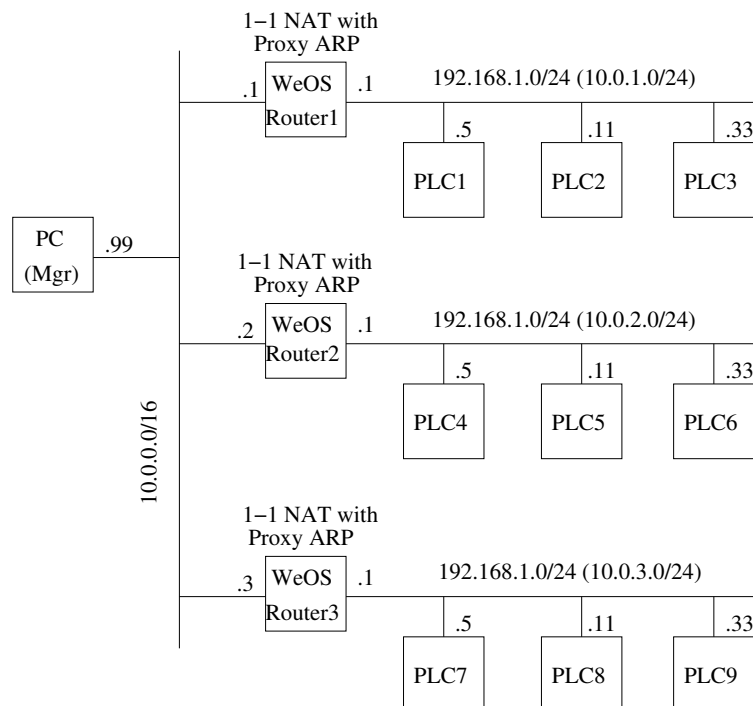



Figure 33.8: Use of proxy ARP with 1-to-1 NAT. The Management PC can reach the PLCs without explicit routes to networks 10.0.1.0/24, 10.0.2.0/24 or 10.0.3.0/24.

Proxy ARP removes the need for explicit routing in some scenarios, but if you are setting up a purely routed configuration, proxy ARP might not be useful, and in some special cases even undesirable. For these special scenarios it is possible to disable Proxy ARP for a 1-to-1 NAT rule. This is done by specifying the CLI keyword **"noarp"** or by un-checking the **Proxy ARP** checkbox in the Web. See [sections 33.2.2.2 \(Web\)](#) and [33.3.6 \(CLI\)](#) for configuration details.

33.1.5.2.5 Proxy ARP, VRRP and 1-to-1 NAT In the case that there is a need for ARP replies from the virtual router instead of ARP replies from the physical interface then 1-to-1 NAT with proxy ARP enabled can have a VRRP virtual router ID as an option. This option is valid if there is a VRRP instance already configured. See the example below and [sections 33.2.2.2 \(Web\)](#) and [33.3.6 \(CLI\)](#) for configuration details.

 **Example**

```
example:/#> config router vrrp 0
Creating new vrrp instance: 0
Invalid settings: Interface not set.
example:/config/router/vrrp-0/#> iface vlan1 address 10.20.30.40 vrid 23
example:/config/router/vrrp-0/#> end end
example:/config/#> ip firewall
Activating firewall, type 'abort' to cancel.
Would you like a set of default filter rules for existing interfaces (y/N)? y
example:/config/ip/firewall/#> nat type 1-to-1 in vlan1 dst 192.168.42.21
to-dst 192.168.55.33 addfilter vrid 23 log
example:/config/ip/firewall/#> leave
example:/#>
```

33.1.5.3 NAT and IP Multicast

Chapter 31 describes WeOS support for IP multicast routing. Combining NAT and IP multicast routing is **not** generally supported, although there exist some specific use cases which work as of WeOS v4.33.0. Furthermore, when using NAT for IP multicast traffic, the address translation only applies to the source IP address of the multicast packet (the source address is a unicast IP address).

33.1.6 Port Forwarding

Port Forwarding is commonly used together with NAT, to enable access from the Internet to a server inside the private network. Fig. 33.9 shows a typical setup when *port forwarding* is useful:

- The switch acts as a NAT/NAPT gateway to the Internet: routing is enabled (see section 22.1) and a NAPT rule defining the external (outbound) interface has been configured (see section 33.1.5).
- A Web Server on the "internal" network serves users on the Internet: A port forwarding rule has been added to allow users on the Internet to initiate connections to the Web server on host 192.168.0.2 (TCP port 80).

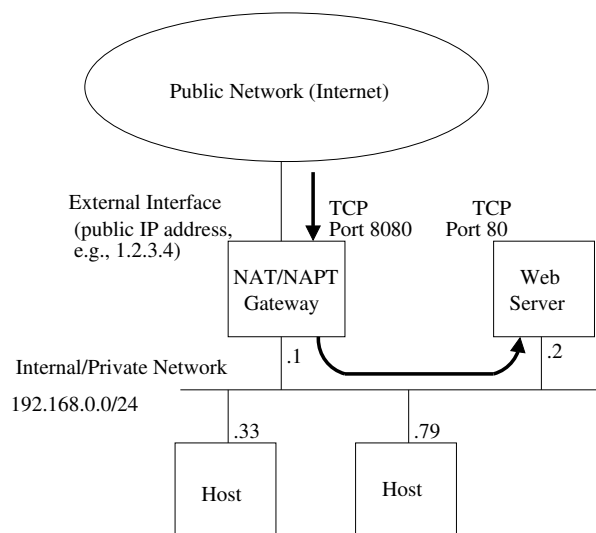

Figure 33.9: Use of port forwarding to enable Internet hosts to access a Web server inside the private network via a NAT/NAPT gateway.

With port forwarding, users on the Internet will connect to the internal Web Server as if it was running on the NAT/NAPT gateway, i.e., users on the Internet will connect to the Web server using the public IP address (here 1.2.3.4) and TCP port number (here 8080), without knowing that the traffic is forwarded to a server inside the internal network.

Configuration of port forwarding rules include the following parameters:

- *Inbound Interface*: Packets which are subject to port forwarding should come in on the specified interface. In the example network shown in [fig. 33.9](#), this would be the *external interface*, i.e., the attached to the Internet.
- *Inbound Port (Range)*: Defines the range of TCP/UDP port numbers, which are to be mapped by this rule. In the example in [fig. 33.9](#) Internet hosts would reach the Web server using TCP port 8080.
- *Source IP Address/Subnet*: Optional argument limiting the port forwarding rule to concern a limited set of Internet hosts.
- *Destination IP Address*: Specifies the IP address of the private server, i.e., where packets are to be sent. The Web server in [fig. 33.9](#) has IP address `192.168.0.2`.
- *Destination Port (Range)* Specifies which TCP/UDP port number(s) to use on the in the forwarded packet. The default is to use the same port number(s) as on the inbound interface. In the example, the Web server on the internal server uses TCP port 80. Note that only single port forwards can change the destination port so that it is different from the original inbound port. Forwarding of a range of ports always keep the port numbers. Multiple single port forwarding rules can be used to form a range in case the destination port numbers must be changed.
- *Transport Protocol (TCP/UDP)*: Specify if this rule applies to TCP, UDP or both. In the example, the rule applies only to TCP.

33.1.7 Firewall Logging

The WeOS firewall supports logging for monitoring and debugging purposes.

Firewall logging is done to the kernel log file **kern.log**, and to a remote syslog if configured. Internal system information will also be written to this file during (re)boot of the system, and some configuration changes may also add information to this log.

This log file can be viewed from the web interface via the **"View Log"** function under the menu: **"Maintenance"**. It can also be viewed in the CLI with the command **"show log://kern.log"**. For more information about log files and configuration of remote syslog, please see [chapter 27](#).

Details about configuration options can be found in [section 33.2](#) (Web), and [section 33.3](#) (CLI).

33.1.7.1 Enabling logging for firewall rules

Logging is enabled for individual rules in the firewall.

Logging is possible for packet filtering rules (both allow and deny), for NAT rules (both NAT and 1-to-1 types) and for port forwarding rules.

Logging is currently not possible for the packet modify operation, however traffic that is modified by packet modify rules is also passing through the forward filtering chain (see [fig. 33.1](#)). It is possible to simulate logging for packet modify by adding a filter allow rule in the forward chain with the same matching condition as the modify rule, and enable logging for that filtering rule.

An entry is added to the log file when an IP packet hits a specific rule with logging enabled. Note that **only the first packet in a connection will be logged**. Subsequent packets or return traffic packets belonging to the same session will not be logged (that would quickly overflow the logs).

Logging enabled for packet filter “deny” rules behave different though, and EVERY packet hitting such a rule will be logged.

33.1.7.2 Settings for rate limitation

The firewall logging system has a rate limitation functionality, preventing excessive amount of log entries to be created upon problems. This will reduce problems due to malicious traffic from outside or inside the network, so called “denial of service” attacks (or DOS attacks), port scanings or similar. It will also avoid problems by excessive logging caused by bad configuration or malfunctioning units in the network causing traffic storms.

The limitation is configured as a maximum rate of log entries per time unit. The time units available are: second, minute, hour or day.

The configuration: “10 per second”, means just that, max 10 log entries will be written to the log file each second.

The rate is continous. This means that the allowance of log entries will be evenly distributed over the time unit. An example: “60 per hour” will allow 60 entries per hour, but distributed evenly as max one log entry per minute.

This makes a rate of “1 per second” to be exactly the same as “60 per minute” and “3600 per hour” (also “86400 per day”, but that can not be configured as the biggest permitted value for any unit is 10000)

It is **not** possible to set non-continuous rates like: 100 entries per calendar day etc.

If the rate limit of log entries is reached, the logging system **will instantly begin throwing away excessive log entries**. The logging will not be buffered or delivered later to the log file.

The rate limitation can be disabled through configuration, but this will open up for potential problems with malicious attacks or storms, therefore **it is not recommended that you disable the limitation mechanism**. But you can and should adjust the limit to fit your needs.

Firewall logging can also be disabled on a system level. Nothing will be logged even if there is logging configured for individual firewall rules.

The default rate limitation will be set to “5 per second” when the firewall is enabled through the web or CLI.

33.1.7.3 Firewall log format

WeOS uses the Linux Netfilter logging mechanism. The standard Netfilter log format is used for recorded entries.

Log entries will be prefixed with the type of rule that was hit, and will always be one of: FW-ALLOW, FW-DENY, FW-NAPT, FW-1TO1 or FW-PF (port forwarding).

Remember that the kernel log is shared with other types of logging. The prefixes are a good way to find the relevant log entries in the file.

You will not see exactly which firewall rule that triggered a log entry, only the type of it. This can be a problem if you use many rules with logging enabled. However, the information provided in the log should be enough to figure out what specific rule was causing it.

A rule position number or some other helping reference to the specific rule may be added in a later release of WeOS.

ere is an example of a kernel log entry generated when a filter ALLOW rule is hit:

```
Jan 15 14:44:49 example kernel: FW-ALLOW: IN=vlan1 OUT=vlan2
MAC=00:07:7c:10:de:c1:00:80:c8:3c:25:b7:08:00:45:00:00:54:c9:84
SRC=192.168.2.10 DST=192.168.3.100 LEN=84 TOS=0x00 PREC=0x00
TTL=63 ID=51588 DF PROTO=ICMP TYPE=8 CODE=0 ID=10941 SEQ=1
```

The same log entry line broken down in parts:

Log text part	Explanation
Jan 15 14:44:49	Timestamp
example	The system host name
kernel:	Identifies origin, kernel.log
FW-ALLOW:	This originates from a firewall filter "allow" rule
IN=vlan1	Inbound interface "vlan1", may be empty for NAT rules
OUT=vlan2	Outbound interface "vlan2"
MAC=	This is the first part from the ethernet packet (this field may be empty for some rules)
00:07:7c:10:de:c1:	The first part is destination MAC address
00:80:c8:3c:25:b7:	This part is the source MAC address
08:00:	Ethertype, 08:00 is IP
45:00:00:54:c9:84	More data, first part of the IP header
SRC=192.168.2.10	Source IP address, always the original IP before any NAT transformation
DST=192.168.3.100	Destination IP address, before NAT
LEN=84 TOS=0x00 PREC=0x00 TTL=63 ID=51588 DF	Packet length and other IP header options
PROTO=ICMP	The IP protocol
TYPE=8 CODE=0 ID=10941 SEQ=1	The rest is protocol specific data and flags, in this specific case an ICMP ping request

Here are example entries for the other types:

*Jan 15 12:45:25 example kernel: FW-NAPT: IN=vlan1 OUT=vlan1 SRC=192.168.2.200
DST=192.168.2.10 LEN=94 TOS=0x00 PREC=0x00 TTL=64 ID=59200 DF
PROTO=UDP SPT=514 DPT=514 LEN=74*

*Jan 15 14:45:12 example kernel: FW-1TO1: IN=vlan1 OUT=
MAC=00:07:7c:10:de:c1:00:80:c8:3c:25:b7:08:00:45:00:00:3c:bd:4b
SRC=192.168.2.10 DST=192.168.2.100 LEN=60 TOS=0x00 PREC=0x00
TTL=64 ID=48459 DF PROTO=TCP SPT=55301 DPT=80 WINDOW=14600
RES=0x00 SYN URGP=0*

*Jan 15 14:45:29 example kernel: FW-PF: IN=vlan1 OUT=
MAC=00:07:7c:10:de:c1:00:80:c8:3c:25:b7:08:00:45:00:00:3c:ca:59
SRC=192.168.2.10 DST=192.168.2.200 LEN=60 TOS=0x00 PREC=0x00
TTL=64 ID=51801 DF PROTO=TCP SPT=55631 DPT=8080 WINDOW=14600
RES=0x00 SYN URGP=0*

*Jan 15 14:49:16 example kernel: FW-DENY: IN=vlan1 OUT=
MAC=00:07:7c:10:de:c1:00:80:c8:3c:25:b7:08:00:45:00:00:1c:4a:ca
SRC=192.168.2.10 DST=192.168.2.200 LEN=28 TOS=0x00 PREC=0x00
TTL=64 ID=19146 PROTO=UDP SPT=2702 DPT=2000 LEN=8*

33.2 Firewall Management via the Web Interface

Menu path: Configuration ⇒ Firewall ⇒ Common

On the firewall common settings page you may enable or disable the firewall.

When disabling the firewall all rules will be lost. A confirmation is required if you try to disable the firewall to not loose rules by accident.

Firewall Common Settings

Enabled

Logging Enabled	<input checked="" type="checkbox"/>
Limit Logging	<input checked="" type="checkbox"/>
Limit	5 per second

Apply Cancel

Enabled	Check this box to enable firewall functionality. Note: When disabling the firewall, the firewall is stopped and all existing <i>NAT</i> rules, <i>Port Forwarding</i> rules, <i>Packet Filter</i> rules and <i>Packet Modify</i> rules are deleted.
Logging Enabled	Check to enable logging for the firewall. This is a master control enabling the logging feature. Note: you also need to enable logging on individual firewall rules for anything to be logged.
Limit Logging	Check to enable rate limitation of the logging. The limit is set in the input boxes below. Warning: Disabling the limitation may lead to lots of data being logged. This can in a short time fill up the log files.
Limit	Set the threshold rate value and time unit for the limitation. See section 33.1.7 for information about how the limitation operates.

33.2.1 NAT Rules

Menu path: Configuration ⇒ Firewall ⇒ NAT

On the Firewall NAT configuration page you are presented to the list of current NAT rules. (If the firewall function is disabled or no rules have been created you will not see any list, but be presented to an information message.)

NAT Rules



New NAT Rule

select	Order	Active	Type	Incoming		Destination			Filter Rule	Proxy ARP	Log		
				Interface	Source Address(es)	Interface	Address(es)	New Address(es)					
<input type="checkbox"/>	1	✓	NAPT			vlan1			✓		✓		
<input type="checkbox"/>	2	✓	1-TO-1	vlan4			10.20.30.0/26	192.168.0.0/26	—	✓	—		
<input type="checkbox"/>	3	✓	NAPT	vlan2	172.16.2.0/25	vlan3			—		—		
<input type="checkbox"/>	4	✓	1-TO-1	vlan1			22.33.44.128/28	192.168.0.32/28	✓	✓	—		

Selected rules

Select All

New Nat Rule	Click this button to create a new NAT rule. You will be presented to a form where you can configure the new rule.
Select	Check this box to select one or a set of rules for group rule management. Check the <i>Select all</i> box at the bottom of the page to select all rules.
Order	The order in which the rules will be applied. When using a JavaScript enabled browser, it is possible to select one or more rules and perform an action on multiple rules, see below. If not using a JavaScript enabled browser, there will be a set of arrows available to move rules up or down to change the order of application.
Active	A green check-mark means the rule is active, and a dash means it is inactive.
Continued on next page	

Continued from previous page	
Type	The NAT type for this rule: NAPT or 1-TO-1
Incoming Interface	The inbound interface for packets that should be NATed
Source Address(es)	The IP address and subnet mask (CIDR) for matching the source address of packets
Destination Interface	The outbound interface.
Destination Address(es)	The IP address and subnet mask (CIDR) for matching the destination address of packets
New Address(es)	The target IP address and subnet mask (CIDR) for 1-TO-1 NAT
Filter Rule	If automatic forwarding filter rules are created for this rule. A green check-mark means yes and a dash means no.
VRID	If a valid VRRP ID is added for this rule the ID is shown or a dash means no VRRP ID is provided for this rule.
Proxy ARP	If Proxy ARP is enabled for a 1-to-1 NAT rule. A green check-mark means yes and a dash means no.
Log	Controls if a match on this rule should be logged in the kernel log file. Nothing will be logged unless logging is also enabled under the common firewall settings.
 Edit	Click this icon to edit a NAT rule.
 Delete	Click this icon to remove a NAT rule. You will be asked to acknowledge the removal before it is actually executed.
Selected Rules	Selected rules may be modified by selecting the rules to modify and select the modification action in the drop-down list and then click the Apply button.

33.2.2 New NAT Rule

Menu path: Configuration ⇒ Firewall ⇒ NAT ⇒ **New NAT Rule**

In the **New NAT Rule** configuration page you can specify a new NAT rule. This page exists in two views depending on what NAT type you want to create. When you enter this page initially, the "NAPT" type is pre-selected. Change the type to "1-TO-1" to see the other view. If you have disabled JavaScript you will only see one view with all fields from both NAPT and 1-TO-1 together.

33.2.2.1 New NAT Rule - NAPT view

New NAT Rule

The screenshot shows the 'New NAT Rule' configuration page. The fields are as follows:

- Active:**
- Type:** NAPT (dropdown menu)
- Incoming Interface:** vlan3 (dropdown menu)
- Source Address(es):** 172.16.2.0 / 24
- Destination Interface:** vlan4 (dropdown menu)
- Automatic Packet Filter Rule:**
- Log:**

Buttons: Apply, Cancel

Active	Rule is active if checked.
Type	NAPT. If you change to 1-TO-1 NAT, the view will change. See section 33.2.2.2 .
Incoming Interface	Optional. The interface connected to your subnet whose addresses you want to translate (the interface to your internal/private network).
Source Address(es)	Optional. The IP address and subnet mask (CIDR) identifying the IP subnet where this NAT rule should be applied.
Continued on next page	

Continued from previous page	
Destination Interface	Mandatory. The interface that should represent all IP addresses on the subnet of the internal interface . This is the external/public interface, typically the interface connected to the Internet.
Automatic Packet Filter Rule	Keep as checked if you want an automatically created rule in the firewall <i>forwarding filter</i> allowing packets that matches this NAT rule. This rule is invisible in the filter configuration. Uncheck it if you want to set up your own rules for controlling traffic.
Log	Controls if a match on this rule should be logged in the kernel log file. Nothing will be logged unless logging is also enabled under the common firewall settings.

33.2.2.2 New NAT Rule - 1-TO-1 NAT view

New NAT Rule

Active	Rule is active if checked.
Type	1-TO-1. If you change to NAPT, the view will change. See section 33.2.2.1 .
Incoming Interface	Mandatory. The inbound interface where traffic arrives to the router
VRRP Virtual Router Identifier	Optional. Choose an available VRID (if any) in the list.
Destination Address(es)	Mandatory. The original external IP address and subnet mask (CIDR) that should be NATed
New Destination Address(es)	Mandatory. The new internal IP address and subnet mask (CIDR) set by the NAT
Automatic Packet Filter Rule	Check if you want automatically created rules in the firewall <i>forwarding filter</i> allowing packets that matches this NAT rule. Rules will be created for both forward direction and for the reverse direction. Keep unchecked if you want to set up your own rules for controlling traffic.
Continued on next page	

Continued from previous page	
Proxy ARP	Check to enable ARP proxying for the <i>Destination Address(es)</i> on the <i>Incoming Interface</i> . You should have this enabled in most cases.
Log	Controls if a match on this rule should be logged in the kernel log file. Nothing will be logged unless logging is also enabled under the common firewall settings.

33.2.3 Edit NAT Rule

Menu path: Configuration ⇒ Firewall ⇒ NAT ⇒ 

In the **Edit NAT Rule** configuration page you can change an existing NAT rule. See [section 33.2.2](#) for description of editable fields.

33.2.4 Port Forwarding Rules

Menu path: Configuration ⇒ Firewall ⇒ Port Forwarding

Port forwarding is e.g. used to give external units access to specific services in a subnet hidden by NAT/NAPT. If the firewall is disabled or no rules have been created you will see no list, but be presented to an information message.

Port Forwarding Rules



New Forwarding Rule

select	Order	Active	Protocol	Incoming			Destination		Log	
				Interface	Destination Port	Source Address(es)	Address	New Port		
<input type="checkbox"/>	1	✓	udp	vlan1	56		145.45.45.45		✓	✎ 🗑
<input type="checkbox"/>	2	✓	tcp	lo	345-348	192.168.212.0/24	135.115.125.65	445-448	-	✎ 🗑
<input type="checkbox"/>	3	✓	ANY	vlan4	84		135.114.125.165		✓	✎ 🗑

Selected rules

 Select All
 Move Up ▼
Apply

New Forwarding Rule	Click this button to create a new port forwarding rule. You will be presented to a form where you can configure the new rule.
Select	Check this box to select one or a set of rules for group rule management. Check the <i>Select all</i> box at the bottom of the page to select all rules.
Order	The order in which the rules will be applied. When using a JavaScript enabled browser, it is possible to select one or more rules and perform an action on multiple rules, see below. If not using a JavaScript enabled browser, there will be a set of arrows available to move rules up or down to change the order of application.
Active	A green check-mark means the rule is active, and a dash means it is inactive.
Continued on next page	

Continued from previous page	
Protocol	Traffic may be filtered on transport layer protocol. Available are TCP and UDP.
Incoming Interface	The interface from which inbound traffic should be allowed.
Incoming Destination Port	The range of transport layer ports to match. E.g. 80 for standard web-server access.
Incoming Source Address(es)	Optional. The source IP address(es) of packets allowed to be forwarded. Either a single address, or a subnet. Subnet mask is displayed in CIDR notation (prefix length).
Destination Address	The destination IP address to which the packets will be forwarded.
Destination New Port	If another port or set of ports are used by the destination host for the service you can map the port(s) by entering another port or set of ports. Number of ports must match the number of incoming destination ports. Empty means that the incoming destination port will be used. Note: New destination port can only be set for single ports. Multi-port ranges can not be remapped to a new port range. You must use multiple single-port mappings to achieve this.
Log	Controls if a match on this rule should be logged in the kernel log file. Nothing will be logged unless logging is also enabled under the common firewall settings.
 Edit	Click this icon to edit a port forwarding rule.
 Delete	Click this icon to remove a port forwarding rule. You will be asked to acknowledge the removal before it is actually executed.
Selected Rules	Selected rules may be modified by selecting the rules to modify and select the modification action in the drop-down list and then click the Apply button.

33.2.5 New Port Forwarding Rule

Menu path: Configuration ⇒ Firewall ⇒ Port Forwarding ⇒ **New Forwarding Rule**

New Port Forwarding Rule

The screenshot shows a configuration form for a new port forwarding rule. The form is titled "New Port Forwarding Rule". It contains several sections:

- Active:** A checked checkbox.
- Protocol:** A dropdown menu set to "any".
- Incoming Interface:** A dropdown menu set to "vlan4".
- Incoming Destination Port(s):** A range selector with "Range start" and "Range end" labels, both set to "84".
- Source:** Radio buttons for "Single" (selected) and "Subnet".
- Address:** An empty text input field.
- Destination Address:** A text input field containing "135.114.125.165".
- New Destination Port:** A range selector with "Range start" and "Range end" labels, both empty.
- Log:** A checked checkbox.

At the bottom of the form, there are two buttons: "Apply" and "Cancel".

Active	Rule is active if checked.
Protocol	Mandatory. Traffic may be filtered on transport layer protocol. Available are TCP and UDP. Choose <i>any</i> to allow both TCP and UDP packets.
Incoming Interface	Mandatory. The interface from which inbound traffic should be allowed.
Incoming Destination Port(s)	Mandatory. The range of transport layer ports to match. E.g. 80 for standard web-server access. If JavaScript is enabled, the range start may be selected in the drop down.
Source	Optional. The source IP address(es) of packets allowed to be forwarded. Either a single address, or a subnet. If single is selected, enter a single address. If subnet is selected a netmask (e.g. 255.255.255.0) must also be entered to define the subnet. If you have a JavaScript enabled browser the netmask field will not be displayed unless you check the subnet radio button.
Destination Address	Mandatory. The destination IP address to which the packets will be forwarded.

Continued on next page

Continued from previous page	
New Destination Port	Optional. If another port or set of ports are used by the destination host for the service you can map the port(s) by entering another port or set of ports. Number of ports must match the number of incoming destination ports. Empty means that the incoming destination port will be used. Note: New destination port can only be set for single ports. Multi-port ranges can not be remapped to a new port range. You must use multiple single-port mappings to achieve this. If JavaScript is enabled, the range start may be selected in the drop down.
Log	Controls if a match on this rule should be logged in the kernel log file. Nothing will be logged unless logging is also enabled under the common firewall settings.

33.2.6 Edit Port Forwarding Rule

Menu path: Configuration ⇒ Firewall ⇒ Port Forwarding ⇒ 

In the **Edit Port Forwarding Rule** configuration page you can change an existing port forwarding rule.

See [section 33.2.5](#) for description of editable fields.

33.2.7 Packet Filter Rules

Menu path: Configuration ⇒ Firewall ⇒ Packet Filter

Packet filter rules are set up to allow traffic to pass through the firewall. Traffic is by default denied, except for a set of default allow rules created.

If the firewall is disabled or no rules have been created you will see no list, but be presented to an information message.

Packet Filter Rules

Default Forward Policy Accept ✎

Filter Rules Enabled Yes ✎



select	Order	Active	Policy	Interface		Source		Destination		Protocol	Log	
				In	Out	Address(es)	Port	Address(es)	Port			
<input type="checkbox"/>	1	✓	allow	lo						icmp	☐	✎ 🗑
<input type="checkbox"/>	2	✓	deny	vlan1	vlan200	10.1.1.0/24	87-89	45.45.45.0/24	113	tcp	✓	✎ 🗑
<input type="checkbox"/>	3	✓	deny	vlan1		10.1.1.99				icmp	☐	✎ 🗑
<input type="checkbox"/>	4	✓	allow	vlan1	vlan200					ANY	✓	✎ 🗑

Selected rules

Select All

Default Forward Policy	The policy defines how to handle data for which no matching rule can be found. The forward chain controls traffic passing through the switch, not traffic destined to the switch itself. Possible values are: Allow Packets will be allowed through. Drop Packets will be dropped and no other actions are taken.
Filter Rules Enabled	Yes means rules are active. No means rules are deactivated and all traffic is allowed through. Individual deactivation of rules override when this setting is yes (active).
✎ Edit	Click this icon to edit the global settings.
Continued on next page	

Continued from previous page	
New Rule	Click this button to create a new packet filter rule. You will be presented to a form where you can configure the new rule.
Select	Check this box to select one or a set of rules for group rule management. Check the <i>Select all</i> box at the bottom of the page to select all rules.
Order	The order in which the rules will be applied. When using a JavaScript enabled browser, it is possible to select one or more rules and perform an action on multiple rules, see below. If not using a JavaScript enabled browser, there will be a set of arrows available to move rules up or down to change the order of application.
Active	A green check-mark means the rule is active, and a dash means it is inactive.
Policy	The type of rule, <i>Allow</i> or <i>Deny</i> .
In Interface	The rule will be applied to traffic entering on this interface.
Out Interface	The rule will be applied to traffic exiting on this interface. If neither <i>Out Interface</i> nor <i>Destination Address</i> (see below) are specified, the rule will apply to the INPUT chain, i.e., traffic destined to the switch itself (ICMP pings, SSH management, etc.).
Source Address(es)	The rule will be applied to traffic originating from a source with this specific IP-address or an IP-address in the specified subnet.
Source Port	The rule will be applied to traffic originating from this set of (UDP/TCP) ports.
Destination Address(es)	The rule will be applied to traffic destined to this specific IP-address or to an IP-address in the specified subnet. If neither <i>Out Interface</i> (see above) nor <i>Destination Address</i> are specified, the rule will apply to the INPUT chain, i.e., traffic destined to the switch itself (ICMP pings, SSH management, etc.).
Destination Port	The rule will be applied to traffic destined to this set of (UDP/TCP) ports.
Continued on next page	

Continued from previous page	
Protocol	The rule will be applied to traffic using this protocol. Select the protocol name or enter the protocol number. If <i>ANY</i> the rule will be applied for all protocol types.
Log	Controls if a match on this rule should be logged in the kernel log file. Nothing will be logged unless logging is also enabled under the common firewall settings.
 Edit	Click this icon to edit a packet filter rule.
 Delete	Click this icon to remove a packet rule. You will be asked to acknowledge the removal before it is actually executed.
Selected Rules	Selected rules may be modified by selecting the rules to modify and select the modification action in the drop-down list and then click the Apply button.

33.2.8 Edit Common Packet Filter Settings

Menu path: Configuration ⇒ Firewall ⇒ Packet Filter ⇒  (Common Settings)

Here you may change the common settings for the packet filter rules.

Filter Rules - Common Settings

Default Forward Policy	<input checked="" type="radio"/> Drop <input type="radio"/> Accept
Filter Rules Enabled	<input checked="" type="checkbox"/>

Default Forward Policy	The policy defines how to handle data for which no matching rule can be found. The forward chain controls traffic passing through the switch, not traffic destined to the switch itself. Possible values are: Allow Packets will be allowed through. Drop Packets will be dropped and no other actions are taken. Select the policy by clicking the radio button.
Filter Rules Enabled	Check the box to activate the rules, or uncheck to deactivate the rules. Deactivation means all traffic is allowed through (policy is changed to <i>allow</i>).

33.2.9 New Packet Filter Rule

Menu path: Configuration ⇒ Firewall ⇒ Packet Filter ⇒ **New Rule**

New Filter Rule

Active	<input checked="" type="checkbox"/>
Policy	<input checked="" type="radio"/> Allow <input type="radio"/> Deny
Position (order)	5
In Interface	vlan1
Out Interface	vlan200
Protocol	6 tcp
Source	<input checked="" type="radio"/> Single <input type="radio"/> Subnet
Address	192.168.1.33
Source Port(s)	Range start: 22 ssh Range end: -
Destination	<input type="radio"/> Single <input checked="" type="radio"/> Subnet
Address	10.1.0.0
Netmask	255.255.0.0
Destination Port(s)	Range start: 443 https Range end: - 445
Log	<input checked="" type="checkbox"/>

Apply Cancel

Active	Rule is active if checked.
Policy	Choose Allow/Deny to select if this rule should allow or deny traffic.
Position (order)	The position in the list defining in what order rules will be applied. Defaults to last position. Change the value to insert this rule in another position.
In Interface	The rule will be applied to traffic entering on this interface.

Continued on next page

Continued from previous page	
Out Interface	The rule will be applied to traffic exiting on this interface. If neither <i>Out Interface</i> nor <i>Destination Address</i> (see below) are specified, the rule will apply to the INPUT chain, i.e., traffic destined to the switch itself (ICMP pings, SSH management, etc.).
Protocol	The rule will be applied to traffic using this protocol. Select IP protocol in drop-down or enter the protocol number to specify for which protocol to apply this rule (see also <i>Destination Port</i> option below). Select <i>any</i> to allow traffic from any IP Protocol (ICMP, TCP, UDP, . . .) through.
Source Address(es)	The rule will be applied to traffic originating from a source with this specific IP-address or an IP-address in the specified subnet. Select <i>Single</i> and enter the single source address into the address field. Select <i>Subnet</i> and enter an address into the address field and a subnet mask into the <i>Netmask</i> field.
Source Port	The rule will be applied to traffic originating from this set of (UDP/TCP) ports. If JavaScript is enabled, the range start may be selected in the drop down. Only valid if <i>Protocol</i> TCP or UDP has been selected (see above).
Destination Address(es)	The rule will be applied to traffic destined to this specific IP-address or to an IP-address in the specified subnet. Select <i>Single</i> and enter the single source address into the address field. Select <i>Subnet</i> and enter an address into the address field and a subnet mask into the <i>Netmask</i> field. If neither <i>Out Interface</i> (see above) nor <i>Destination Address</i> are specified, the rule will apply to the INPUT chain, i.e., traffic destined to the switch itself (ICMP pings, SSH management, etc.).
Destination Port	The rule will be applied to traffic destined to this set of (UDP/TCP) ports. If JavaScript is enabled, the range start may be selected in the drop down. Only valid if <i>Protocol</i> TCP or UDP has been selected (see above).
Continued on next page	

Continued from previous page	
Log	Controls if a match on this rule should be logged in the kernel log file. Nothing will be logged unless logging is also enabled under the common firewall settings. Note: Logging differs in behavior between policy <i>Accept</i> and <i>Deny</i> . See section 33.1.7 for more details.

33.2.10 Edit Packet Filter Rule

Menu path: Configuration ⇒ Firewall ⇒ Filter ⇒ 

In the **Edit Packet Filter Rule** configuration page you can change an existing packet filter rule.

See [section 33.2.9](#) for description of editable fields.

33.2.11 DPI Filter Rules

Menu path: Configuration ⇒ Firewall ⇒ DPI Filter

DPI filter rules works similar to packet filter rules (see [section 33.2.7](#)). There are a few additional requirements for DPI rules. For now only Modbus is implemented. Only *allow* rules are used. An implicit deny rule will be added after the last DPI Modbus rule that denies all Modbus traffic that has not been explicitly allowed to pass. Either *out interface* or *destination address* must be specified. Further, the *protocol* is always TCP and the *destination port* must also be specified (default 502). See [section 33.1.3](#) for more information about the TCP Modbus firewall.

DPI Filter Rules

[New Rule](#)

select	Order	Active	Policy	Interface		Source		Destination		DPI	Log
				In	Out	Address(es)	Port	Address(es)	Port		
<input type="checkbox"/>	1	✔	Allow	vlan1	vlan2	10.0.3.1			502	modbus function: 1 - 4	⊞
<input type="checkbox"/>	2	✔	Allow	vlan1	vlan2	10.0.3.7			502	modbus function: 1 - 4	⊞

Selected rules

 Select All Move Up ▼ Apply

The only difference to the packet filter rules page is that the *Protocol* column has been replaced by a DPI column which shows the Modbus filter settings for each rule.

33.2.12 New DPI Rule

Menu path: Configuration ⇒ Firewall ⇒ DPI Filter ⇒ **New Rule**

New DPI Rule

Active	<input checked="" type="checkbox"/>
Policy	<input checked="" type="radio"/> Allow
Position (order)	<input type="text" value="3"/>
In Interface	<input type="text" value=""/>
Out Interface	<input type="text" value=""/>
Protocol	<input type="text" value="tcp"/>
Source	<input checked="" type="radio"/> Single <input type="radio"/> Subnet
Address	<input type="text" value=""/>
Source Port(s)	Range start <input type="text" value="..."/> Range end <input type="text" value="-"/>
Destination	<input checked="" type="radio"/> Single <input type="radio"/> Subnet
Address	<input type="text" value=""/>
Destination Port(s)	Range start <input type="text" value="502"/> Range end <input type="text" value="modbus"/> <input type="text" value="-"/>
DPI type	<input type="text" value="modbus"/>
Modbus function	Range start <input type="text" value=""/> - <input type="text" value=""/>
Modbus unit	Range start <input type="text" value=""/> - <input type="text" value=""/>
Modbus register	Range start <input type="text" value=""/> - <input type="text" value=""/>
Log	<input type="checkbox"/>

This page is similar to the *new packet filter* page described in [section 33.2.9](#). The difference is that protocol is always *TCP* and policy is always *allow*. The new fields are the DPI fields. Only *Modbus* is selectable from the *DPI type* drop-down list. Then there are three optional Modbus filters: *function* code, *unit* ID and *register* address. They can each be a single number or a consecutive range. See [section 33.1.3](#) for further explanation.

33.2.13 Packet Modify Rules

Menu path: Configuration ⇒ Firewall ⇒ Modify

Modify rules are set up to change the priority of packets passing through the firewall.

- Rules are evaluated in the listed order from the top and downwards.
- Rules are only used if the configured parameters match.
- A matching rule will result in the DSCP field in the packets being changed to the configured value, and the next rule is then evaluated. The final value will thus be from the last matching rule.

Optionally the *adjust priority* adjusts the (internal) priority handling of the packet inline with to the new DSCP value. In addition, the VLAN tag priority will be set accordingly if the packet egresses the switch tagged.

If the firewall is disabled or no rules have been created you will see no list, but be presented to an information message.

Modification Rules



[New](#)

select	Order	Active	Interface		Source		Destination		Protocol	DSCP	Adjust Priority	
			In	Out	Address(es)	Port	Address(es)	Port				
<input type="checkbox"/>	1	✓	vlan1	vlan200	10.1.1.1	22			tcp	40	✓	
<input type="checkbox"/>	2	✓	vlan1		10.1.1.99				icmp	18	—	
<input type="checkbox"/>	3	✓	vlan1	vlan200	10.1.1.1		45.45.45.45		ANY	14	✓	
<input type="checkbox"/>	4	✓	vlan1		192.168.2.1	53		101	udp	28	✓	

Selected rules

 Select All Move Up ▼ Apply

New	Click this button to create a new modify rule. You will be presented to a form where you can configure the new rule.
Continued on next page	

Continued from previous page	
Order	The order in which the rules will be applied. When using a JavaScript enabled browser, it is possible to select one or more rules and perform an action on multiple rules, see below. If not using a JavaScript enabled browser, there will be a set of arrows available to move rules up or down to change the order of application.
Active	A green check-mark means the rule is active, and a dash means it is inactive.
In Interface	The rule will be applied to traffic entering on this interface.
Out Interface	The rule will be applied to traffic exiting on this interface.
Source Address(es)	The rule will be applied to traffic originating from a source with this specific IP-address or an IP-address in the specified subnet.
Source Port	The rule will be applied to traffic originating from this set of (UDP/TCP) ports.
Destination Address(es)	The rule will be applied to traffic destined to this specific IP-address or to an IP-address in the specified subnet.
Destination Port	The rule will be applied to traffic destined to this set of (UDP/TCP) ports.
Protocol	The rule will be applied to traffic using this protocol. Select the protocol name or enter the protocol number. If <i>ANY</i> the rule will be applied for all protocol types.
DSCP	The DSCP value to be set for packets matching this rule.
Adjust	Indicates if the modified DSCP value should be used for switch internal prioritising and applied to VLAN-priority on tagged packets. A green check-mark means yes and a dash means no.
 Edit	Click this icon to edit a modify rule.
 Delete	Click this icon to remove a modify rule. You will be asked to acknowledge the removal before it is actually executed.
Selected Rules	Selected rules may be modified by selecting the rules to modify and select the modification action in the drop-down list and then click the Apply button.

33.2.14 New Modify Rule

Menu path: Configuration ⇒ Firewall ⇒ Modify ⇒ **New**

New Modification Rule

Active	<input checked="" type="checkbox"/>
Position (order)	<input type="text" value="5"/>
In Interface	vlan1 ▼
Out Interface	vlan200 ▼
Protocol	... ▼
Source	<input type="radio"/> Single <input checked="" type="radio"/> Subnet
Address	<input type="text" value="192.168.2.0"/>
Netmask	<input type="text" value="255.255.255.0"/>
Source Port(s)	Range start: ... ▼ Range end: -
Destination	<input checked="" type="radio"/> Single <input type="radio"/> Subnet
Address	<input type="text"/>
Destination Port(s)	Range start: 179 Range end: 179 bgp ▼ -
DSCP	
Set Value	<input type="text" value="38"/>
Adjust Priority	<input checked="" type="checkbox"/>

Active	Rule is active if checked.
Position (order)	The position in the list defining in what order rules will be applied. Defaults to last position. Change the value to insert this rule in another position.
In Interface	The rule will be applied to traffic entering on this interface.
Out Interface	The rule will be applied to traffic exiting on this interface.
Continued on next page	

Continued from previous page	
Protocol	The rule will be applied to traffic using this protocol. Select IP protocol in drop-down or enter the protocol number to specify for which protocol to match with this rule (see also <i>Destination Port</i> option below). Select <i>any</i> to match any IP Protocol (ICMP, TCP, UDP, ...).
Source Address(es)	The rule will be applied to traffic originating from a source with this specific IP-address or an IP-address in the specified subnet. Select <i>Single</i> and enter the single source address into the address field. Select <i>Subnet</i> and enter an address into the address field and a subnet mask into the <i>Netmask</i> field.
Source Port	The rule will be applied to traffic originating from this set of (UDP/TCP) ports. If JavaScript is enabled, the range start may be selected in the drop down. Only valid if <i>Protocol</i> TCP or UDP has been selected (see above).
Destination Address(es)	The rule will be applied to traffic destined to this specific IP-address or to an IP-address in the specified subnet. Select <i>Single</i> and enter the single source address into the address field. Select <i>Subnet</i> and enter an address into the address field and a subnet mask into the <i>Netmask</i> field.
Destination Port	The rule will be applied to traffic destined to this set of (UDP/TCP) ports. If JavaScript is enabled, the range start may be selected in the drop down. Only valid if <i>Protocol</i> TCP or UDP has been selected (see above).
DSCP - Set Value	The DSCP value to be set for packets matching this rule. Valid values 0-63.
DSCP Adjust Priority	Indicates if the modified DSCP value should be used for switch internal prioritising and applied to VLAN-priority on tagged packets. Check to enable.

33.2.15 Edit Modify Rule

Menu path: Configuration ⇒ Firewall ⇒ Modify ⇒ 

In the **Edit Modification Rule** configuration page you can change an existing modify rule.

It is also possible to move the rule to a certain position in the list by changing the *Position (order)* field. The rule will be inserted on requested position and the rule currently on the position will be shifted down.

See [section 33.2.14](#) for description of editable fields.

33.2.16 Configure ALG Helpers

Menu path: Configuration ⇒ Firewall ⇒ ALG Helper

In the **ALG Helper** configuration page you can activate Application Level Gateway (ALG) Helpers in the firewall.

ALG Helper

Application Level Gateway Helpers

FTP	<input type="checkbox"/>
H.323	<input type="checkbox"/>
IRC	<input type="checkbox"/>
PPTP	<input type="checkbox"/>
SIP	<input type="checkbox"/>
TFTP	<input type="checkbox"/>

Check the box for the ALG helper to activate.

See [section 33.1.1](#) for description of ALG helpers.

33.3 Firewall Management via the CLI

Command	Default	Section
<u>Configure Firewall Settings</u>		
[no] firewall	Disabled	Section 33.3.1
[no] enable	Enabled	Section 33.3.2
[no] filter [pos <NUM>] <allow deny> [in <IFNAME>] [out <IFNAME>] [src <ADDR[/LEN]>] [sport <RANGE>] [dst <ADDR[/LEN]>] [dport <RANGE>] [proto <NAME NUM>] [passive] [log]		Section 33.3.3
[no] dpi [pos <NUM>] <allow> [in <IFNAME>] [out <IFNAME>] [src <ADDR[/LEN]>] [sport <RANGE>] [dst <ADDR[/LEN]>] <dport <RANGE>> <proto tcp> [passive] [log] <modbus [function <RANGE>]> [unit <RANGE>] [register <RANGE>]>		Section 33.3.4
[no] modify [pos <NUM>] [match [in <IFNAME>] [out <IFNAME>] [src <ADDR[/LEN]>] [sport <RANGE>] [dst <ADDR[/LEN]>] [dport <RANGE>] [proto <NAME NUM>]] set dscp <NUM> [adjust-prio] [passive]		Section 33.3.5
[no] nat [<NUM>] type <NAPT 1-TO-1> [in <IFNAME>] [out <IFNAME>] [src <ADDR[/LEN]>] [dst <ADDR[/LEN]>] [to-dst <ADDR[/LEN]>] [addfilter] [noarp] [passive] [log] [vrid <VRID>]		Section 33.3.6
[no] port-forward in <IFNAME>:<PORTRANGE> [src <ADDR/LEN>] dst <ADDR>[:PORTRANGE] [proto <tcp udp>] [passive] [log]		Section 33.3.7
[no] alg <ftp tftp sip irc h323 pptp>	Disabled	Section 33.3.8
[no] spi	Disabled	Section 33.3.9
policy [forward input] <deny allow>	Deny	Section 33.3.10

Continued on next page

Continued from previous page		
Command	Default	Section
move [filter dpi modify nat port-forward] <FROM-POS> <TO-POS>		Section 33.3.11
[no] passive [filter dpi modify nat port-forward] <POS>		Section 33.3.12
[no] log limit (none <entries>/(second minute hour day))		Section 33.3.13
[no] log [filter dpi nat port-forward] <POS>		Section 33.3.13
<u>View Firewall Status</u> show firewall		Section 33.3.14

33.3.1 Managing the Firewall

Syntax [no] firewall

Context [IP Configuration](#) context

Usage Enter the Firewall Configuration context. This will enable the firewall (unless it is already enabled).

Use **"no firewall"** to disable the firewall, and to delete all existing *NAT*, *Port Forwarding*, *Packet filter (allow/deny)*, and *ALG helper* rules.

Use **"show firewall"** to show the firewall configuration. If the firewall is enabled, the list of currently configured Packet filtering, Modify, NAT and Port forwarding rules are presented. Also available as **"show"** command within the Firewall Configuration context.

Default values Disabled.

33.3.2 Enable Packet Filter Rules

Syntax [no] enable

Context [Firewall Configuration](#) context

Usage Enable/disable packet filtering. This setting affects the activation of packet filtering (allow/deny) rules, and the activation of the default policies. Modify,

NAT, Port Forwarding, and ALG helper rules are unaffected (they are always enabled).

Use **"enable"** to (re)activate *all* configured packet filtering (allow/deny) rules and the configured default policies for the input and forward filter.

Use **"no enable"** to deactivate *all* the configured packet filtering (allow/deny) rules. Default forward policy will be *accept* and default input policy will be *drop*. ICMP will be allowed on the ingress filter.

Use **"show enable"** to show whether the configured packet filters are enabled or disabled.

It is also possible to activate/deactivate individual allow/deny rules (as well as NAT and port forwarding rules), see [section 33.3.12](#).

Default values Enabled

33.3.3 Configure Packet Filter Rule

Syntax [no] filter [pos <NUM>] <allow|deny> [in <IFNAME>]
[out <IFNAME>] [src <ADDR[/LEN]>] [sport <PORTRANGE>]
[dst <ADDR[/LEN]>] [dport <PORTRANGE>] [proto <NAME|NUM>]
[passive] [log]

Context Firewall Configuration context

Usage Add or delete a packet filter *allow* or *deny* rule.

- *Rule maintenance parameters (insert position, activate/deactivate or delete rule):*
 - Allow and deny rules are inserted (and thus evaluated) in a certain order in the input or forward filter. The **"pos <NUM>"** parameter controls at what position in the rule order this packet filter rule should be inserted, or when it comes to removing a rule, which packet filter rule to remove. The order is kept compact (see "Delete rule" below). Use the **"show filter"** command to list the current packet filter rule list and their position numbers. Examples:
 - * *Insert rule:* Use, e.g., **"filter pos 4 allow in vlan2"** will insert an *allow rule* at a specific position (here position 4) in the list of packet filter rules. The rule previously at position 4 will now have position 5, and so on.

If no position argument is given, the packet filter rule will be inserted last in the list. The position of a command can be modified using the **"move"** command (see [section 33.3.11](#)).

- * *Delete rule:* Use, e.g., **"no filter pos 5"** to delete the packet filter rule (allow or deny) at a specific position (here position 5) in the list of packet filter rules. The rule previously at position 6 will now have position 5, and so on, keeping the list compact.

A rule can also be deleted by using the *no*-form of the filter specification, e.g., the rule **"filter deny in vlan1 out vlan2"** can be deleted by the command **"no filter deny in vlan1 out vlan2"**.

- The **"passive"** parameter specifies that this rule is created as inactive. It will be shown in config but not used. To enable use **"passive"** command, see [section 33.3.12](#).
- The **"log"** parameter enables logging for traffic that matches this filter rule. Nothing will however be logged if logging is enabled here but disabled under the common settings. See [section 33.3.13](#).
Note: Logging differs in behavior between policy *Accept* and *Deny*. See [section 33.1.7](#) for more details.

- *Filter specification parameters:*

- The first parameter is mandatory and select the action type **"allow"** or **"deny"**.
- The **"in <IFNAME>"** and **"src <ADDR[/LEN]>"** are used to match the inbound interface and source IP address of a packet. If the **"LEN"** parameter is omitted the **"src <ADDR/LEN>]"** argument will match a single source IP address. If included it will match a whole IP subnet.
- Include the **"out <IFNAME>"** and/or **"dst <ADDR[/LEN]>"** arguments to define a FORWARDING rule (i.e., packets being routed through the switch). If both the **"out <IFNAME>"** and the **"dst <ADDR[/LEN]>"** arguments are omitted, the rule will apply to the INPUT chain, i.e., traffic destined to the switch itself (ICMP pings, SSH management, etc.).
The **"out <IFNAME>"** argument is used to match the outbound interface of a packet.

Use the "**dst <ADDR[/LEN]>**" to match a single destination IP address or whole subnet. If both the "**out <IFNAME>**" and the "**dst <ADDR[/LEN]>**" arguments are omitted, the rule will apply to the INPUT chain, i.e., traffic destined to the switch itself (ICMP pings, SSH management, etc.).

- Use the "**proto <NAME|NUM>**" to match the IP protocol name, e.g., *tcp*, *udp* or *icmp*. It is also possible to specify the protocol's assigned number, see <http://www.iana.org/assignments/protocol-numbers/>.
- Use the "**dport <PORTRANGE>**" argument to specify a destination UDP or TCP port number or port range (ex: 1000-1010). This argument is only valid if "**proto udp**" or "**proto tcp**" is included.
- Use the "**sport <PORTRANGE>**" argument to specify a source UDP or TCP port number or port range (ex: 87-89). This argument is only valid if "**proto udp**" or "**proto tcp**" is included.

Default values Not applicable.

33.3.4 Configure DPI Filter Rule

Syntax [no] dpi [pos <NUM>] allow [in <IFNAME>]
[out <IFNAME>] [src <ADDR[/LEN]>] [sport <PORTRANGE>]
[dst <ADDR[/LEN]>] <dport <PORTRANGE>> <proto tcp>
<modbus [function <RANGE>] [unit <RANGE>] [register <RANGE>]>
[passive] [log]

Context Firewall Configuration context

Usage Add or delete a DPI *allow* rule.

DPI (Deep Packet Inspection) rules are set up to allow certain traffic to pass through the firewall. At the moment only Modbus TCP rules are supported, enabling filtering on Modbus packets and optionally on fields for Modbus *function code*, *unit ID* and *register addresses*.

See [section 33.1.3](#) for a general description about Modbus TCP firewall support. Also consult the configuration examples below.

Default values Modbus TCP destination port; value 502.

Examples

 **Example**

```
example:/config/ip/firewall/#> dpi allow out vlan3 proto tcp dport 502 modbus function 1-4
example:/config/ip/firewall/#> show dpi
1 dpi allow out vlan3 proto tcp dport 502 modbus function 1-4 unit 23
```

The example allows *function* codes 1-4 (the most common read functions) to pass through the firewall going out on interface vlan3. An implicit rule (not shown) will always be added last dropping all other Modbus traffic, including all write functions. This is a simple way to implement *read-only* whitelist access with only one rule. If needed *unit* id and/or *register* address can also be added to the same rule. But take care if using the register filter. They may have to be given off-by-one compared to the PLC setting and also note that coils, holding registers and other registers have individual ranges. If the register filter must be used it is better to create one rule for each function code that should be allowed to pass.

The next example first removes the DPI rule created above, then creates two rules. One to allow function 1 (Read Coils) to read all coils and another rule to allow function 5 (Write Single Coil) to write one specific coil.

 **Example**

```
example:/config/ip/firewall/#> show dpi
1 dpi allow out vlan3 proto tcp dport 502 modbus function 1-4 unit 23
example:/config/ip/firewall/#> no dpi 1
example:/config/ip/firewall/#> dpi allow out vlan3 proto tcp dport 502 modbus function 1
example:/config/ip/firewall/#> dpi allow out vlan3 proto tcp dport 502 modbus function 5 register 2
example:/config/ip/firewall/#> show dpi
1 dpi allow out vlan3 proto tcp dport 502 modbus function 1
2 dpi allow out vlan3 proto tcp dport 502 modbus function 5 register 2
```

Now it will be possible to read all coils on all units with function 1 but it will only be possible to write to the coil with coil address 2 using function 5. All other Modbus packets will be dropped by an implicit drop rule (see [section 33.1.3](#)). Note that the off-by-one problem might exist in the second rule. Verify by recording and inspecting the traffic that should pass before creating the rule. It is the actual number in the network packet that should go into the register filter.

33.3.5 Configure Packet Modify Rule

Syntax [no] modify [pos <NUM>] [passive]
[match [in <IFNAME>] [out <IFNAME>]
[src <ADDR[/LEN]>] [sport <PORTRANGE>]
[dst <ADDR[/LEN]>] [dport <PORTRANGE>]
[proto <NAME|NUM>]]
set dscp <VALUE> [adjust-prio]

Context Firewall Configuration context

Usage Add or delete a modify rule to change the DSCP bits in the IP header for routed traffic.

- *Rule maintenance parameters (insert position, activate/deactivate or delete rule):*

- Modifier rules are inserted and evaluated in order. The "**pos <NUM>**" parameter controls at what position in the rule order this modify rule should be inserted, or when it comes to removing a rule, which rule to remove. The order is kept compact (see "Delete rule" below). Use the "**show modify**" command to list the current modifier rule list and their position numbers. Examples:

* *Insert rule:* Use, e.g., "**modify pos 4 match in vlan2 set dscp 30**" will insert a modifier rule at position 4 in the list of modifier rules. The rule previously at position 4 will now have position 5, and so on.

If no position argument is given, the modifier rule will be inserted last in the list. The position of a command can be modified using the "**move**" command (see [section 33.3.11](#)).

* *Delete rule:* Use, e.g., "**no modify pos 5**" to delete the modifier rule at position 5 from the list of modifier rules. The rule previously at position 6 will now have position 5, and so on, keeping the list compact.

A rule can also be deleted by using the *no*-form, e.g., the rule "**modify match in vlan1 out vlan2 set dscp 0**" can be deleted by the command "**no modify match in vlan1 out vlan2 set dscp 0**".

- The "**passive**" parameter specify that this rule is created as inactive. It will be shown in config but not used. To enable use

"passive" command, see [section 33.3.12](#).

- *Matching parameters:*

Matching parameters are optional. If you do not specify matching, all routed packets will have the DSCP field set. Matching is enabled with the **"match"** keyword followed by one or more of the filters described below:

- The **"in <IFNAME>"** and **"out <IFNAME>"** are used to match on the inbound interface or the outbound interface.
- **"src <ADDR[/LEN]>"** and **"dst <ADDR[/LEN]>"** match on IP source or IP destination. The **"LEN"** parameter is used to define an IP subnet, and if it is omitted it will only match a specific single IP address.
- Use the **"proto <NAME|NUM>"** to match on traffic with a specific IP protocol. You can use the name, e.g., *tcp*, *udp* or *icmp*, or the protocol's assigned number (see <http://www.iana.org/assignments/protocol-numbers/>).
- Use the **"dport <PORTRANGE>"** argument to specify a destination UDP or TCP port number or port range (ex: 1000-1010). This argument is only valid if **"proto udp"** or **"proto tcp"** is included.
- Use the **"sport <PORTRANGE>"** argument to specify a source UDP or TCP port number or port range (ex: 87-89). This argument is only valid if **"proto udp"** or **"proto tcp"** is included.

- *Setting parameters:*

- Use **"set dscp <VALUE>"** to define the DSCP value to be set on all packets matching the parameters described above. The value must be provided as a decimal number in the range 0-63.
- Add parameter **"<adjust-prio>"** if the internal priority of the packet also should be updated in addition to the change of the DSCP field. The internal priority is used to determine what network queue to use in WeOS networking and hardware. Avoid using this option if not necessary, as it introduces additional work for the CPU in the unit, reducing total performance of the system.

Default values Not applicable.

33.3.6 Configure NAT Rule

Syntax [no] nat [<POS>] [type <napt|1-to-1>] [in <IFNAME>]
[out <IFNAME>] [src <ADDR[/LEN]>] [dst <ADDR[/LEN]>]
[to-dst <ADDR[/LEN]>] [addfilter] [noarp] [passive] [log]
[<vrid>]

Context Firewall Configuration context

Usage Add or delete a NAT rule.

- *Add a NAPT NAT rule*

These keywords are available for creating NAPT rules:

- **"type napt"**. Select NAPT.
- **"out <IFNAME>"**. Mandatory. The outbound interface used for NAPT. Outgoing packets handled by this rule will appear to originate from the IP number configured (the primary address) or acquired (DHCP) for this interface.
- **"in <IFNAME>"**. Optional. Specify that packets must arrive from this interface for this rule to apply.
- **"src <ADDR[/LEN]>"**. Optional. Specify that packets must originate from a specific IP subnet for this rule to apply.
- **"addfilter"**. If set, an automatic (invisible) packet filter rule will be created in the *forward filtering* chain allowing packets matching this NAT rule. Do not set this option if you want to manage forwarding rules yourself.
- **"passive"**. Specify that this rule is created as inactive. It will be shown in config but not used. To enable use **"passive"** command, see [section 33.3.12](#).
- **"log"**. Enables logging for traffic that matches this NAT rule. Nothing will however be logged if logging is enabled here but disabled under the common settings. See [section 33.3.13](#).
- **"<vrid>"**. Only available for 1-t-1 NAT rule. See below.

- *Add a 1-to-1 NAT rule*

These keywords are available for creating 1-to-1 NAT rules:

- **"type 1-to-1"**. Select 1-to-1 NAT.

- "**in <IFNAME>**". Mandatory. The inbound interface used for 1-to-1 NAT.
 - "**dst <ADDR[/LEN]>**". Mandatory. Packets arriving on the inbound interface and has the IP destination within this subnet will be NATed.
 - "**to-dst <ADDR[/LEN]>**". Mandatory. The new destination IP network for the NAT. Must be of exact same size as the "**dst**" network.
 - "**addfilter**". If set, automatic (invisible) packet filter rules will be created in the *forward filtering* chain allowing packets matching this NAT rule. Rules are created for both the forward and reverse direction (see [section 33.1.5.2](#)). Do not set this option if you want to manage forwarding rules yourself.
 - "**noarp**". Specify to disable ARP proxying for this rule. (see [section 33.1.5.2](#) for details).
 - "**passive**". Specify that this rule is created as inactive. It will be shown in config but not used. To enable use "**passive**" command, see [section 33.3.12](#).
 - "**log**". Enables logging for traffic that matches this NAT rule. Nothing will however be logged if logging is enabled here but disabled under the common settings. See [section 33.3.13](#).
 - "**<vrid>**". If a valid VRRP Identifier is provided, the corresponding VRRP interface will be used as in-interface.
- *Delete a NAT rule*
Use the command "**no nat <POS>**" to delete a specific NAT rule on the position POS as shown with the command "**show**" or "**show nat**". Delete all NAT rules with "**no nat**".

Use "**show nat**" to show configured NAT rules.

Default values Addresses without subnet lengths will be considered to be of length /32 i.e. as a single IP address.

33.3.7 Configure Port Forwarding Rule

Syntax [no] port-forward in <IFNAME>:<PORTRANGE> [src <IPADDRESS/LEN>] dst <IPADDRESS>[:PORTRANGE] [proto <tcp|udp>] [passive] [log]

Context [Firewall Configuration](#) context

Usage Add/delete a Port Forwarding rule. This is commonly used when the switch is acting as NAT gateway, see [section 33.3.6](#). E.g., **"port-forward in vlan1:80 dst 10.0.0.2 proto tcp"** to forward all web traffic coming in on interface *vlan1* to the Web server at IP address 10.0.0.2 (port 80).

- The argument **"<IFNAME>:<PORTRANGE>"** specifies incoming interface, and what port or port range to match.
- Use the **"[src <IPADDRESS[/LEN]>]"** to match a single source IP address or whole subnet.
- Use the **"dst <IPADDRESS>[:PORTRANGE]"** to specify where the packets should be forwarded. If the **"PORTRANGE"** parameter is omitted, the same port range as specified in the **"<IFNAME>:<PORTRANGE>"** argument is used.
- Use the **"[proto <tcp|udp>]"** to specify if the rule applies to TCP or UDP. If omitted, the rule applies to both.
- The **"passive"** parameter specify that this rule is created as inactive. It will be shown in config but not used. To enable use **"passive"** command, see [section 33.3.12](#).
- The **"log"** parameter enables logging for traffic that matches this port forwarding rule. Nothing will however be logged if logging is enabled here but disabled under the common settings. See [section 33.3.13](#). Use **"show port-forward"** to show configured *port forwarding* rules.

Default values Not applicable.

33.3.8 Configure Application Level Gateway (ALG) Helpers

Syntax [no] alg <ftp|tftp|sip|irc|h323|pptp>

Context [Firewall Configuration](#) context

Usage Enable/disable ALG helper for a protocol, e.g., use **"alg ftp"** to make your firewall or NAT gateway handle FTP traffic appropriately.

Use **"no alg <PROTO>"** to remove an enabled ALG helper for the given protocol, or use **"no alg"** to remove all enabled ALG helpers.

Use **"show alg"** to show list of protocols for which ALG helpers have been enabled.

Default values Disabled.

33.3.9 Configure Stateful Packet Inspection

Syntax [no] spi

Context Firewall Configuration context

Usage Stateful packet inspection will drop packet that are in an invalid state. An example of a packet with an "invalid" state is when a firewall sees a TCP "SYN+ACK", without having seen the preceding TCP "SYN" in the other direction.

For a true firewall it is generally a good idea to enable stateful packet inspection. However, due to potential problems with asymmetric routing, the default is to have this setting disabled.

Use "**show spi**" to show if stateful inspection is enabled or disabled.

Default values Disabled.

33.3.10 Configure Forwarding and Input Default Policies

Syntax policy [forward|input] <allow|deny>

Context Firewall Configuration context

Usage Configure the default policy for *forward filtering* and *input filtering*. By default, the command applies to the *forwarding filter*, e.g., "**policy allow**" will set the default policy for forward filtering to "**allow**".

Use "**show policy**" to show configured default policies for the *forwarding filter* and the *input filter*.

Default values Deny (that is, both the forwarding filter and the input filter by default drop packets lacking a matching *allow* rule.)

33.3.11 Reorder/Move a Packet Filter, Modify, NAT or Port Forwarding Rule

Syntax move [<filter|modify|nat|port-forward>] <FROM_POS> <TO_POS>

Context Firewall Configuration context

Usage Change the position (reorder) a rule in the "**filter**", "**modify**", "**nat**" or "**port-forward**" table, e.g., use "**move filter 6 3**" to move the filter rule (allow/deny) at position "6" to position "3". The filter rule previously at position "3" ends up at position "4", and so on. Similarly, "**move modify 3 6**"

will move the modify rule at position "3" to position "6"; the rule previously at position "6" ends up at position "5" and so on.

The tables are kept compact. Specifying a **"TO_POS"** beyond the highest number in that table is equal to moving it to the last position in the table.

If no table is specified, the move operation applies to the **"filter"** table, i.e., **"move 6 3"** is equivalent to **"move filter 6 3"**.

Examples

Example

```
example:/config/ip/firewall/#> show filter
001 filter allow in vlan1 out vlan2
002 filter allow in vlan1 out vlan3
003 filter deny in vlan1 out vlan2 proto icmp
example:/config/ip/firewall/#> move filter 3 1
example:/config/ip/firewall/#> show filter
001 filter deny in vlan1 out vlan2 proto icmp
002 filter allow in vlan1 out vlan2
003 filter allow in vlan1 out vlan3
```

33.3.12 Activate/Deactivate a Packet Filter, Modify, NAT, or Port Forwarding Rule

Syntax [no] passive [<filter|modify|nat|port-forward>] <POS>

Context Firewall Configuration context

Usage Activate or deactivate a packet filter (allow/deny) rule, a modify rule, a NAT rule, or a port forwarding rule. E.g., use **"passive filter 4"** to deactivate the packet filter rule at position "4".

Use commands **"show filter"**, **"show modify"**, **"show nat"** or **"show port-forward"** to display the current list of rules for that specific type.

Use the "no"-form to activate a previously deactivated rule, e.g., **"no passive modify 4"** activates modify rule "4".

Examples

 **Example**

```
example:/config/ip/firewall/#> show filter
001 filter allow in vlan1 proto icmp
002 filter allow in vlan2 proto icmp
003 filter deny in vlan1 out vlan2 proto icmp
004 filter allow in vlan1 out vlan2
example:/config/ip/firewall/#> passive filter 3
example:/config/ip/firewall/#> show filter
001 filter allow in vlan1 proto icmp
002 filter allow in vlan2 proto icmp
003 filter deny in vlan1 out vlan2 proto icmp passive
004 filter allow in vlan1 out vlan2
example:/config/ip/firewall/#> no passive filter 3
example:/config/ip/firewall/#> show filter
001 filter allow in vlan1 proto icmp
002 filter allow in vlan2 proto icmp
003 filter deny in vlan1 out vlan2 proto icmp
004 filter allow in vlan1 out vlan2
```

33.3.13 Configuration of firewall logging

This command has two uses, [1] to configure logging (and limit), and [2] to toggle the log flag on firewall rules.

Syntax 1 [no] log limit (none | <entries>/(<second|minute|hour|day>)

Syntax 2 [no] log [filter|nat|port-forward] <POS>

Context [Firewall Configuration](#) context

Usage 1 Enable/disable firewall logging and set rate limitation of firewall log entries. This is a master control enabling the logging feature.

A rate limit must be provided or “none” to disable limit, i.e. log everything. The limit is set as a number followed by a slash character “/” and a time unit. The time unit is one of “second”, “minute”, “hour” or “day”. See [section 33.1.7](#) for information about how limitation operates.

All firewall logging is disabled by using the command: **“no log”**

Use **“show log”** to show if firewall logging is enabled or disabled, and the rate limitation setting.

 **Note**

Besides enabling logging with this command, you also need to enable logging on individual firewall rules for anything to be logged.



Warning

Enabling logging and disabling the limitation may lead to lots of data being logged. This can in a short time fill up the log files.

Usage 2 Enable/disable logging for an existing individual packet filter, NAT or port forwarding rule. E.g., use **"log filter 4"** to enable logging for the packet filter rule at position "4".

Use commands **"show filter"**, **"show nat"** or **"show port-forward"** to display the current list of rules for that specific type. Rules containing the keyword **"log"** has logging enabled.

Use the **"no"**-form to disable logging for an existing rule, e.g., **"no log nat 2"** disables logging for the NAT rule at position "2".

Logging can not be enabled for packet modify rules.

Default values Logging is enabled by default when the firewall is enabled, however no automatically created firewall rule will have the log parameter enabled by default. The default logging limit is set at 5 entries per second.

Examples with usage 1



Example

```
example:/config/ip/firewall/#> log limit 100/day
example:/config/ip/firewall/#> show log
Logging is Enabled, limited to 100 entries/day
example:/config/ip/firewall/#> log limit none
example:/config/ip/firewall/#> show log
Logging is Enabled, no rate limitation
example:/config/ip/firewall/#> no log
example:/config/ip/firewall/#> show log
Logging is Disabled
```

Examples with usage 2



Example

```
example:/config/ip/firewall/#> show filter
001 filter allow in vlan1 proto icmp
002 filter allow in vlan2 proto icmp
003 filter deny in vlan1 out vlan2 proto icmp
004 filter allow in vlan1 out vlan2
example:/config/ip/firewall/#> log filter 2
example:/config/ip/firewall/#> show filter
```

```
001 filter allow in vlan1 proto icmp
002 filter allow in vlan2 proto icmp log
003 filter deny in vlan1 out vlan2 proto icmp
004 filter allow in vlan1 out vlan2
example:/config/ip/firewall/#> no log filter 2
example:/config/ip/firewall/#> show filter
001 filter allow in vlan1 proto icmp
002 filter allow in vlan2 proto icmp
003 filter deny in vlan1 out vlan2 proto icmp
004 filter allow in vlan1 out vlan2
```

33.3.14 View Firewall Status

Syntax show firewall

Context Admin Exec context

Usage Show current NAT rules, Port Forwarding rules, policies and entries in the Input and Forwarding Filters and Modifier rules. In addition, management interface configuration (see [section 22.2.7](#)) will appear as entries in the *Input Filter*.

Default values Not applicable.

Part IV

Virtual Private Networks and Tunnels

Chapter 34

Overview of WeOS VPN and Tunnel support

This chapter introduces WeOS support for virtual private networks (VPNs), IPsec and SSL VPN, as well as support for tunneling/point-to-point functionality (GRE and PPP). Although GRE and PPP can be used as part of VPNs, they can also be used as standalone features, e.g., to setup IP communication over a serial link.

34.1 WeOS support for VPNs

As shown in [fig. 34.1](#), a WeOS unit can act as a VPN gateway in NETWORK-NETWORK and HOST-NETWORK scenarios, also referred to as *site-to-site* VPN and *remote access* VPN respectively. Configured as a VPN gateway, the unit can be used to securely connect branch office networks with a central office network, or to serve individual users wishing to "dial in" securely over the Internet to the central office network, with their PC connected at some remote location. The data traffic will be protected by encrypted tunnels when sent over the Internet.

WeOS provides two flavours of VPN, which both support NETWORK-NETWORK and HOST-NETWORK VPN scenarios.

- *IPsec VPNs*: WeOS supports IPsec VPNs with IKEv1 (shared key and certificates) for authentication, and ESP for encapsulation of encrypted IP packets.
- *SSL VPN*: The WeOS SSL VPN support is based on OpenVPN¹.

¹<http://www.openvpn.net>

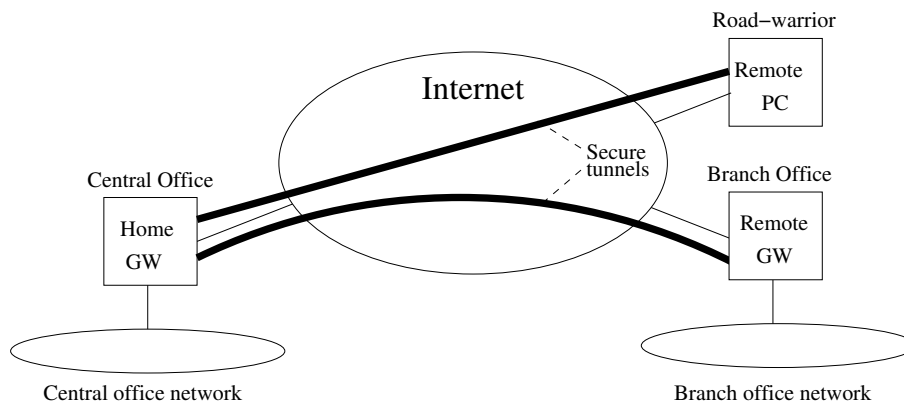

Figure 34.1: IPsec VPN tunnels can be used to securely connect hosts and networks over the Internet.

Both IPsec and SSL VPNs offer high level security. SSL VPNs are commonly considered easier to configure, and is often preferred to setup VPNs through firewalls managed by an external organisation. In some situations IPsec is the only choice, as it may be mandated by the customers.

Both SSL and IPsec VPNs are able to carry encrypted IP traffic. The WeOS SSL VPN is also able to carry encrypted Ethernet traffic, however, as of WeOS v4.33.0 this traffic can be *routed* but not *bridged*. Support for bridged SSL VPNs is planned, but not yet supported. IPsec VPNs are further described in [chapter 37](#) and SSL VPNs are covered in [chapter 38](#).

34.2 Tunneling using PPP

WeOS supports PPP over serial ports (as PPP client and server), and PPP over Ethernet (PPPoE) as client. PPP support is further described in [chapter 35](#).

34.3 Tunneling using GRE

WeOS provides support for GRE tunnels (IP over GRE), which is useful in scenarios where IPsec VPNs and OSPF are used to provide secure and redundant connectivity between branch offices and a central office. WeOS GRE support is covered in [chapter 36](#).

Chapter 35

Point-to-Point Protocol (PPP) Connections

WeOS provides two types of PPP services:

- PPPoE (Ethernet/DSL): WeOS supports PPPoE client services on LAN. The PPPoE client operates on Ethernet and DSL ports (SHDSL, ADSL, VDSL) associated with a VLAN network interface.
- PPP over Serial Port: On serial ports, WeOS supports PPP dial in/out services with or without external modem.

This chapter describes PPP support in WeOS in general, with focus on how to create PPP instances, and configuration of low-level PPP settings for PPPoE and PPP over serial ports. PPP shares some functionality with other WeOS services, thus additional information relevant for PPP configuration is found at the following locations:

- General Interface settings: A network interface will be created for each PPP instance. Configuration of network interfaces is described in [chapter 22](#).
- PPPoE on Falcon (xDSL): [Section 13.2.1](#) provides useful information when using PPPoE on a Falcon xDSL router.
- Serial Port Settings: When running PPP over a serial port, there general serial port settings to be carried out in addition to the PPP settings described in this chapter. Configuration of serial port is described in [chapter 40](#).
- Peer authentication: To authenticate the peer side of the PPP connection a local PPP user database is used. Configuration of local user databases is

covered in [chapter 9](#).

35.1 Overview of PPP Instance Properties and Management Features

Feature	Web	CLI	General Description
Link types			
Ethernet (PPPoE client)	X	X	Section 35.1.1-35.1.3
Serial/modem	X	X	Section 35.1.1-35.1.2 , and Section 35.1.4
PPP Link Establishment			
MRU negotiation	X	X	Section 35.1.2
PPP authentication			
Protocols: PAP,CHAP, ...	X	X	Section 35.1.2 , 35.1.5
Username/password	X	X	Section 35.1.2 , 35.1.5
Peer authentication	X	X	Section 35.1.2 , 35.1.5 , and Chapter 9
MPPE Encryption	X	X	Section 35.1.2 , 35.1.6
IP/Interface			
Address Assignment	X	X	Section 35.1.7
Proxy ARP	X	X	-"
On demand dialing	X	X	-"
Other interface settings (default route, etc.)	X	X	Chapter 22

35.1.1 Introduction to PPP

The Point-to-Point Protocol (PPP)[[46](#)] is a common data link protocol for point-to-point links. PPP is able to carry different kinds of layer-3 protocols, and can be used in several contexts. WeOS supports IP (IPv4) service over PPP for the following link types:

- *PPP over Serial Link:* PPP can be used as data link protocol over serial links, e.g., by connecting to units directly via a serial (null-modem) cable, or over a PSTN by use of modems.
- *PPP over Ethernet:* PPP can be used on Ethernet (or DSL) by use of the PPP over Ethernet (PPPoE) protocol[[33](#)]. WeOS provides a PPPoE client service, which is commonly used when connecting to an ISP via an xDSL connection.

As of WeOS v4.33.0, WeOS units can establish a single PPP connection using PPPoE, and a single PPP connection over serial port¹.

35.1.2 Phases in the PPP connection establishment

The two units establishing a PPP connection are referred to as *peers* in PPP terminology[46]. Here we will either denote them as *PPP peers*, or as *PPP client* and *PPP server* when referring the unit *initiating* the connection (i.e., dial-out) or the unit *waiting* for an incoming call (i.e., dial-in) respectively.

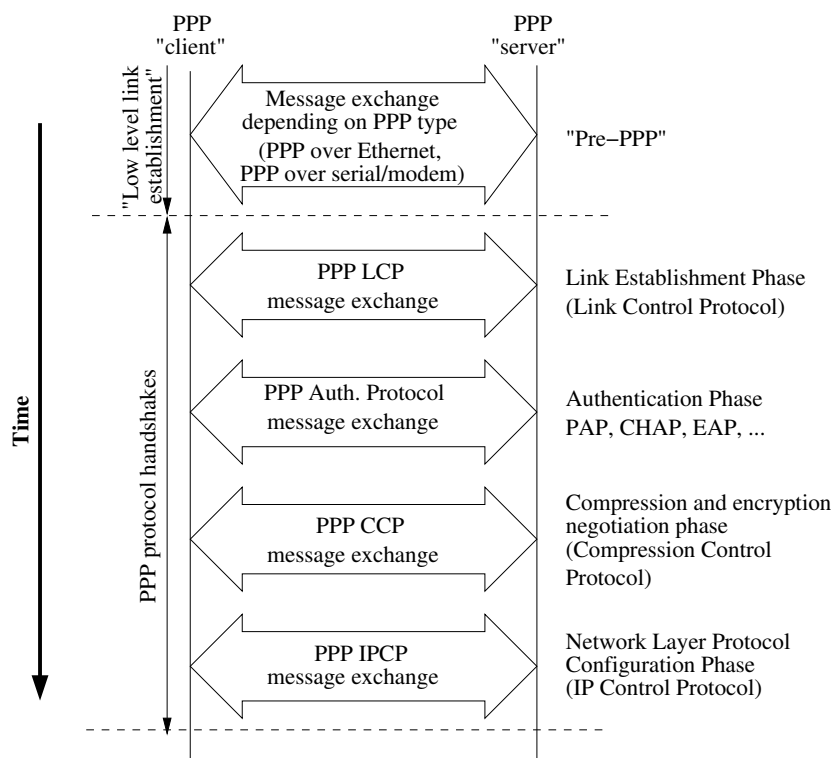

Figure 35.1: PPP Connection Establishment Phases

Establishment of a PPP connection is divided into several phases, as shown in fig. 35.1:

- *“Low-level” link establishment (Pre-PPP):* Before a PPP connection can be established, a point-to-point “link” must exist, either as a physical link (serial

¹PPP can be run over the serial port of the WeOS serial port, but not via its console port. See section 1.5.1 for information on WeOS units equipped with serial ports.

line), or as a logical link (PPP over Ethernet).

- *PPPoE*: To create a point-to-point connection over an Ethernet, the PPPoE protocol is used. Once the PPPoE handshake has finished, the PPP Link Establishment phase can start. See [section 35.1.3](#) for more information on PPPoE specific settings.
- *PPP over Serial Port*: For PPP over serial link, it is enough to configure the serial ports and the external modem (if used) to establish the physical link. No pre-PPP phase exists – the PPP Link Establishment phase starts immediately. See [section 35.1.4](#) for additional information on how to configure the serial port and modem.
- *PPP Link Establishment Phase*: Once the point-to-point link is up, the PPP peers start to exchange PPP Link Control Protocol (LCP) messages. LCP is used to negotiate general settings, which are *independent of the network layer protocol(s)* used on top, e.g., the maximum receive unit (MRU), or what authentication protocol to use (if any). LCP is also used by the PPP peers to send LCP Echo Request/Reply messages, to verify connectivity once the link is up. As of WeOS v4.33.0 the LCP Echo Interval is 20 seconds (fixed), and the link is considered down after failing to receive three LCP responses.
- *PPP Authentication Phase*: During the Link Establishment phase, the peers can negotiate the use (and type) of authentication. See [section 35.1.5](#) for more information on WeOS support for PPP authentication.
- *Compression and Encryption Negotiation Phase*: After the Link Establishment and Authentication phases, the PPP peers can use the PPP compression control protocol (CCP[42]) to negotiate link layer compression or encryption (typically the Microsoft Point-To-Point Encryption (MPPE) Protocol[37]). See [section 35.1.6](#) for more information on WeOS support for PPP encryption.

As of WeOS v4.33.0 PPP link layer compression is not supported.

- *Network Control Protocol Phase*: Once the link has been established via LCP, and the optional authentication and compression handshakes are carried out, PPP can start to negotiate network level settings via one or more network layer protocols. Here the PPP IP Control Protocol (IPCP[34]) is used to negotiate IP Settings. Acting as PPP client, WeOS units will use IPCP to acquire an IP address for the PPP interface, as well as its domain name server(s).

Note

The domain name servers learnt via IPCP will only be used if the PPP interface has lowest *admin distance* (see [section 22.2.6](#)), and if no static domain name server is configured. Similarly, the peer will only be used as default gateway if the PPP interface has lowest *admin distance* and if no static default route has been configured.

35.1.3 PPP over Ethernet (PPPoE)

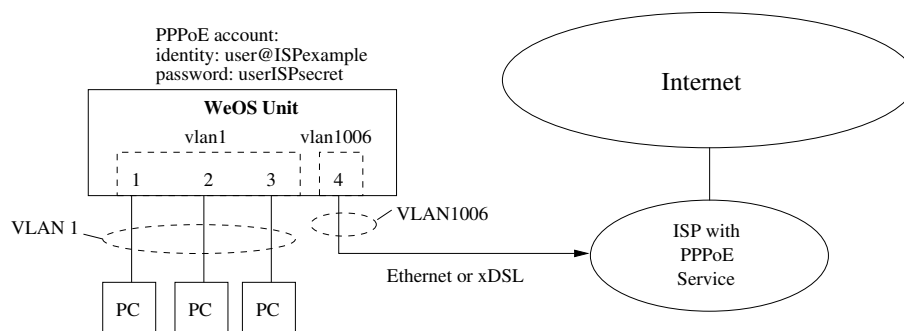

Figure 35.2: Example where WeOS unit routes traffic to Internet using PPPoE.

PPPoE is a protocol to establish a PPP connection over an Ethernet network. It is commonly used when connecting to an ISP over an xDSL or Ethernet connection, since PPPoE enables the use of PPP's features for user authentication and dynamic IP assignment. [Fig. 35.2](#) shows a sample setup.

To configure PPPoE in WeOS you need to specify the following:

- The VLAN interface to run PPPoE over, i.e., the VLAN your upstreams xDSL or Ethernet port is associated with. In [fig. 35.2](#) interface `vlan1006` is used.
- The *identity* and *password* assigned to you by your ISP (this is the PAP/CHAP username and password mentioned in [section 35.1.2](#)). In [fig. 35.2](#) identity `user@ISPexample` and password `userISPsecret` are used.
- (Optionally) Some access network are shared between multiple ISPs. In order to connect to the PPPoE Server of your ISP, you then need to fill in the *service name* provided by your ISP. This step can typically be skipped.

[Section 13.2.1](#) provides additional information, which is useful when setting up PPPoE on a Falcon xDSL router.

35.1.4 PPP over Serial Port

PPP over a Serial Port is in WeOS configured in the Modem context. For details of the configuration of the actual serial port see [chapter 40](#).

The Serial PPP can be set up in 4 modes.

- *Null modem*: Two devices can be connected directly using a *null modem* cable (a serial cable where transmit and receive are cross-linked).

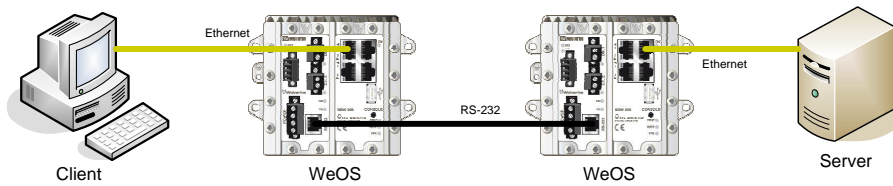

Figure 35.3: PPP - Null modem setup example

To setup a null modem PPP is simple. Select *null modem* as mode on both sides, and change the *local IP address* on one side in the PPP context.

- *Dial in:* Allows for a remote client to dial in to the device over a PSTN or leased line.

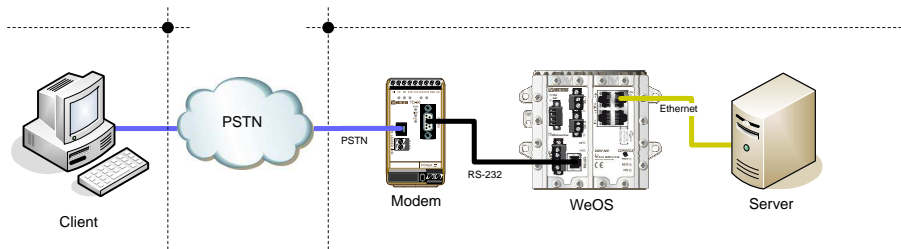

Figure 35.4: PPP - Dial in setup example

To setup a null modem PPP is simple. Select Null modem as mode on both sides and change Local IP on one side in the PPP context.

- *Dial out:* Allows for a local device to establish a PPP connection on demand over a PSTN or leased line.

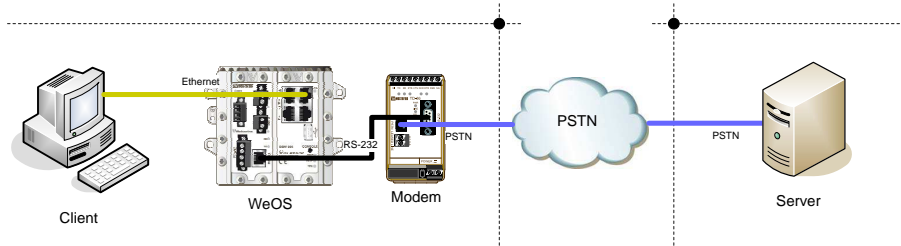

Figure 35.5: PPP - Dial out setup example

- *Dial in & out:* A combination of Dial in and out. Allows for both connections on demand and for incoming requests.

To setup a modem connected to the unit, WeOS provides an *initialisation string*. This AT-sequence is transmitted to the modem during system configuration. The default string is **ATE0Q0V1&C1&S0S0=0&W** (see [table 35.1](#) for more information).

The initialisation string is not used when connecting via *null modem* cable.

The *dial string* is the AT-sequence that starts the connection attempt. A typical dial string is **ATDnnn** where *nnn* is the phone number to dial. If the modem uses a leased line the dial string typically is **ATD**.

E0	Disable Echo
Q0	Set Quite mode off
V1	Set Verbose mode on
&C1	Set DCD to follow the state of a carrier
&S0	Set DSR signal to follow mode (data or command)
S0=0	Disable auto-answer
&W	Save settings

Table 35.1: Breakdown of the initialisation string.

The dial string is not used when connecting via a *null modem* cable.

35.1.5 PPP Authentication Support

PPP enables you to authenticate yourself to your peer. This is typically needed when using PPPoE to connect to your ISP. To accomplish this, you add your *credentials* (identity/username and password) to your PPP configuration.

PPP also enables you to authenticate your peer, which is useful when you provide a *dial-in* service, but can also be used for *dial-out*. As of WeOS v4.33.0, a *local* database list (see [section 9.1.1.2](#)) can be configured with credentials of authorised peers. Later releases of WeOS may include PPP support for backend authentication, e.g., via RADIUS. Peer authentication is by default *Disabled*.

WeOS supports authentication using the password authentication protocol (PAP[30]) and challenge handshake authentication protocol (CHAP), including regular CHAP[45], MS-CHAP[70] and MS-CHAPv2[69]. By default all authentication protocols are available, but it is possible to specify which protocol(s) to use². In WeOS the same set of authentication protocols are available for authenticating yourself to the peer as for the peer to authenticate to you.

When using MPPE to encrypt your PPP session (see [section 35.1.6](#)), use of MS-CHAPv2 or MS-CHAP is required.

35.1.6 PPP Encryption Support

WeOS provides support for the Microsoft Point-To-Point Encryption (MPPE) Protocol[37]), either with 40 or 128 bit key lengths. By enabling MPPE you achieve a basic level of protection of your PPP session. However, to reach a higher level

²If more than one protocol are available, a WeOS unit will propose protocols in the following preference order: CHAP, MS-CHAPv2, MS-CHAP, and finally PAP.

of security it is recommended to use IPsec VPNs or SSL VPNs (OpenVPN) as described in [chapters 37](#) and [38](#).

Use of MPPE requires that either MS-CHAPv2 or MS-CHAP are used for authentication, see [section 35.1.5](#). MPPE is *disabled* by default.

35.1.7 IP and PPP network interfaces

Configuration of IP settings of PPP interfaces is handled somewhat differently as compared to other network interfaces in WeOS. The main reason is that PPP contains more options related to IP settings.

The following PPP related IP or interface settings are configured in the *Modem* or *PPPoE* contexts . Most important are the *local* and *remote* IP address settings:

- *Local IP address*: Your local IP address can either be assigned dynamically by the peer, or you can assign a static IP address for your PPP interface.
- *Remote IP address*: You can either assign an IP address to your peer, or accept the peer to use an IP address chosen by itself.
- *Proxy ARP*: A WeOS unit will by default apply *proxy ARP* to its PPP connections. With *proxy ARP* enabled for a PPP connection, the WeOS unit will check if the PPP peer's IP address matches any local IP subnet. The unit will then respond to ARP requests for the peer's IP address on that local VLAN.

E.g., if the remote PPP address is *10.1.0.10*, and this matches the subnet of the local interface *vlan1* with address *10.1.0.2/24*, the WeOS unit will respond to ARP requests for *10.1.0.10* on *vlan1*.

- *On demand dialing*: PPP interfaces are commonly brought up immediately. However, in some use cases it is preferred to only have the PPP connection up when the units are actively sending traffic. The connection is brought up when there is traffic to be routed through that path, and brought down after a configurable idle timeout. To get traffic routed through the PPP interface (and bring it up) you can use a static route. A static 0.0.0.0/0 route to the PPP interface sets it as default.

On demand dialing is only applicable in PPP scenarios where the unit is acting as *client*, i.e., dialing out to a PPP *server*. On demand dialing is disabled by default.

Below is an example where the local address of a PPP null modem interface is set to *192.168.5.1* and the address *192.168.5.2* is assigned to the peer.

Example

```
example:/#> configure
example:/config/#> modem 0
Creating modem 0
Dial-mode: Null-modem
Serial port: 2
example:/config/modem-0/#> address 192.168.5.1
example:/config/modem-0/#> remote-address 192.168.5.2
example:/config/modem-0/#> end
example:/config/#> end
Stopping DHCP/DNS Server ..... [ OK ]
Starting DHCP/DNS Server ..... [ OK ]
Starting Modem link monitor ..... [ OK ]
Configuration activated. Remember "copy run start" to save to flash (NVRAM).
example:/#> copy running startup
example:/#>
```

For every PPP connection there is an associated PPP interface (e.g., "**modem0**" or "**pppoe0**"), and these interfaces are treated as regular interfaces in WeOS with additional configuration options, see [chapter 22](#). In particular, if you wish to learn your *default route* and *DNS servers* dynamically from your PPP peer, you should give your PPP interface *admin distance "1"*, see [section 22.2.6](#).

Below is an example where a PPP null-modem connection is configured to get its IP address, default route and name servers from its peer. In addition, here management of the unit through this PPP interface is limited to HTTPS.

Example

```
example:/#> configure
example:/config/#> modem 0
Creating modem 0
Dial-mode: Null-modem
Serial port: 2
example:/config/modem-0/#> no address
example:/config/modem-0/#> no remote-address
example:/config/modem-0/#> end
example:/config/#> iface modem0
example:/config/iface-modem0/#> distance 1
example:/config/iface-modem0/#> no management
example:/config/iface-modem0/#> management https
example:/config/iface-modem0/#> end
example:/config/#> end
Starting Modem link monitor ..... [ OK ]
Configuration activated. Remember "copy run start" to save to flash (NVRAM).
example:/#> copy running startup
example:/#>
```

35.2 Managing PPP settings via the web interface

The Web interface provides configuration of PPP connections, both for PPPoE (sections 35.2.1-35.2.2) and for PPP over modem/serial port (sections 35.2.3-35.2.4).

35.2.1 PPPoE overview

Menu path: Configuration ⇒ PPP ⇒ PPPoE

PPPoE

Name	Interface	Service Name	Username	
pppoe0	vlan1006		test	 

New

Figure 35.6: PPP settings overview

Click on the Edit icon () to edit the settings of a specific PPPoE instance.

35.2.2 Edit PPPoE Settings

Menu path: Configuration ⇒ PPP ⇒ PPPoE ⇒ 

On this page you can change the settings for PPP connections.

The page has two views, a simple view (fig. 35.7) and an advanced view (fig. 35.8).

Edit PPPoE

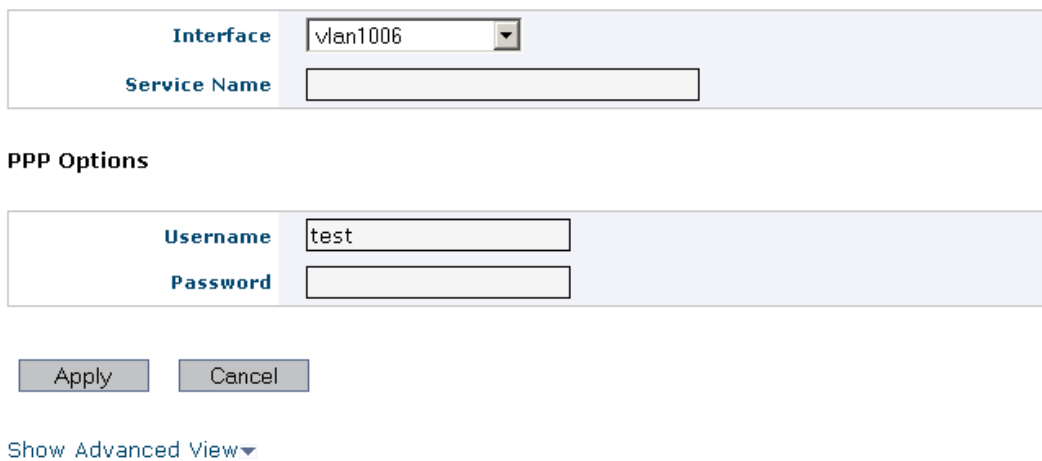

The screenshot shows the 'Edit PPPoE' configuration page. At the top, there is a section for 'Interface' with a dropdown menu set to 'vlan1006' and a 'Service Name' text input field. Below this is a section for 'PPP Options' containing 'Username' (text input with 'test') and 'Password' (text input). At the bottom of the form are 'Apply' and 'Cancel' buttons, and a 'Show Advanced View' link with a downward arrow.

Figure 35.7: PPPoE edit page

Type	Type of PPP link
Interface	Interface for binding of PPP link.
Username	Username for authenticating against the peer
Password	Password for authenticating against the peer
Local IP	The Local IP for this link
Remote IP	The Remote IP for this link
Peer Authentication	Enable authentication of peers
Authentication Protocol	Select authentication protocol(s)
Crypto	Select link encryption
Dial-on-demand	Enable Dial-on-demand and sets disconnect time-out
MRU Negotiation	Enable maximum receive unit (MRU) negotiation

PPPoE

Interface	vlan1006
Service Name	

PPP Options

Username	test
Password	
Peer Authentication	Disabled
Authentication Protocol	Auto <input checked="" type="checkbox"/>
Crypto	None
Dial-on-demand	Disabled
MRU Negotiation	Disabled
Local IP	Disabled
Remote IP	Disabled

[Show Simple View ▲](#)

Figure 35.8: PPPoE advanced edit page

35.2.3 Modem overview

Menu path: Configuration ⇒ PPP ⇒ Modem

MODEM





Id	Serial Port	Enabled	Dial	
0	1	✓	Null modem	 

Figure 35.9: Modem settings overview

Click on the Edit icon () to edit the settings of a specific Modem instance.

35.2.4 Edit Modem Settings

Menu path: Configuration ⇒ PPP ⇒ Modem ⇒ 

On this page you can change the settings for Modem connections.

The page has two views, a simple view and an advanced view.

Modem 0

ID	0
Enabled	<input checked="" type="checkbox"/>
Serial Port	1
Dial	Null modem
Init String	ATE0Q0V1&C1&D2&S0S0=0&W
Dial String	ATD

PPP Options

Username	test	Password	
Local IP	Enabled	Address	10.1.0.1
Remote IP	Disabled		

Show Advanced View ▼

ID	The instance id
Enabled	Enable/disable this instance
Serial Port	The serial port to use
Dial	Set the mode of the modem.
Init String	Set the AT-sequence to initialize a modem
Dial String	Set the AT-sequence to dial the remote host
Username	Username for authenticating against the peer
Password	Password for authenticating against the peer
Local IP	The Local IP for this link
Remote IP	The Remote IP for this link
Peer Authentication	Enable authentication of peers

Continued on next page

Continued from previous page	
Authentication Protocol	Select authentication protocol(s)
Crypto	Select link encryption
Dial-on-demand	Enable Dial-on-demand and sets disconnect time-out
MRU Negotiation	Enable maximum receive unit (MRU) negotiation

Modem advanced edit page

Modem 0

ID	0
Enabled	<input checked="" type="checkbox"/>
Serial Port	1
Dial	Null modem
Init String	ATE0Q0V1&C1&D2&S0S0=0&W
Dial String	ATD

PPP Options

Username	test	Password	
Local IP	Enabled	Address	10.1.0.1
Remote IP	Disabled		
Peer Authentication	Disabled		
Authentication Protocol	Auto <input checked="" type="checkbox"/>		
Crypto	None		
Dial-on-demand	Disabled		
MRU Negotiation	Enabled		

Show Simple View ▲

35.3 Managing PPP settings via the CLI

Table 35.3 shows CLI commands related to *PPPoE management*.

For *PPP over serial port* (and modems) there are two tables to summarise the CLI commands: Table 35.5 presents commands the CLI commands in a generic way, while Table 35.6 describes CLI commands and default values depending on the *dial mode* ("**dial in**", "**dial out**", "**dial in,out**" and "**no dial**" (i.e., "null-modem")).

Command	Default	Section
<u>Basic and advanced settings for PPPoE</u>		
[no] pppoe <ID>		Sec. 35.3.1
[no] iface <IFNAME>	Disabled	Sec. 35.3.2
[no] service-name <SERVICE-NAME>	Disabled	Sec. 35.3.3
[no] enable	Enabled	Sec. 35.3.9
[no] identity <USERNAME> password <PASSWORD>	Disabled	Sec. 35.3.10
[no] ppp-advanced		Sec. 35.3.11
[no] address <IPV4ADDR>	Auto	Sec. 35.3.12
[no] remote-address <IPV4ADDR>	Auto	Sec. 35.3.13
[no] auth-proto <pap, ... >	Disabled	Sec. 35.3.14
[no] aaa-method local-db <ID>	Disabled	Sec. 35.3.15
[no] crypto <mppe-40 mppe-128>	Disabled	Sec. 35.3.16
[no] proxy-arp	Enabled	Sec. 35.3.17
[no] demand <IDLE-TIMEOUT>	Disabled	Sec. 35.3.18
[no] mru	Enabled	Sec. 35.3.19
<u>Configure Peer Authentication Lists</u>		
aaa		
[no] local-db <ID> [plain]		Sec. 9.3.5
...		

Table 35.3: CLI setting relevant for PPPoE management. All PPP settings are available in the "ppp-advanced" subcontext. The most common PPP settings are (also) available in the main "pppoe" context.

Command	Default	Section
Basic and advanced settings for PPP over serial/modem		
[no] modem <ID>		Sec. 35.3.4
[no] port <SERIALPORT>	"First Free"	Sec. 35.3.5
[no] dial <in, out>	Null-modem	Sec. 35.3.6
[no] init-string <STRING>	ATE...	Sec. 35.3.7
[no] dial-string <STRING>	ATD	Sec. 35.3.8
[no] enable	Enabled	Sec. 35.3.9
[no] identity <USERNAME>	Disabled	Sec. 35.3.10
password <PASSWORD>		
[no] ppp-advanced		Sec. 35.3.11
[no] address <IPV4ADDR>	Differs	Sec. 35.3.12
[no] remote-address <IPV4ADDR>	Differs	Sec. 35.3.13
[no] auth-proto <pap, ... >	Disabled	Sec. 35.3.14
[no] aaa-method local-db <ID>	Disabled	Sec. 35.3.15
[no] crypto <mppe-40 mppe-128>	Disabled	Sec. 35.3.16
[no] proxy-arp	Enabled	Sec. 35.3.17
[no] demand <IDLE-TIMEOUT>	Disabled	Sec. 35.3.18
[no] mru	Enabled	Sec. 35.3.19
Serial Port Settings		
port serial <SERIALPORT>		Sec. 40.3.1
[no] speed <50-2000000>	115200	Sec. 40.3.2
...		
Configure Peer Authentication Lists		
aaa		
[no] local-db <ID> [plain]		Sec. 9.3.5
...		

Table 35.5: CLI setting relevant for management of PPP over serial ports with or without external modem. All PPP settings are available in the "ppp-advanced" subcontext. The most common PPP settings are (also) available in the main "modem" context.

Command	Comment	Section
<u>No-dial/Null-modem defaults and contexts</u>		
modem <ID>		
no dial	Null-modem	Sec. 35.3.6
address 10.1.0.1	Default Local IP	Sec. 35.3.12
no remote-address	Accept Remote IP	Sec. 35.3.13
(no init-string)	N/A	Sec. 35.3.6
(no dial-string)	N/A	Sec. 35.3.8
ppp-advanced		
(no demand)	N/A	Sec. 35.3.18
<u>Dial-In specific defaults and contexts</u>		
modem <ID>		
dial in	Dial-In	Sec. 35.3.6
address 10.1.0.1	Default Local IP	Sec. 35.3.12
remote-address 10.1.0.2	Default Remote IP	Sec. 35.3.13
no aaa-method	Basic	Sec. 35.3.15
ppp-advanced		
(no demand)	N/A	Sec. 35.3.18
<u>Dial-Out specific defaults and contexts</u>		
modem <ID>		
dial out	Dial-Out	Sec. 35.3.6
no address	Dynamic Local IP	Sec. 35.3.12
no remote-address	Accept Remote IP	Sec. 35.3.13
ppp-advanced		
no demand	Advanced	Sec. 35.3.18
<u>Dial-In/Out specific defaults and contexts</u>		
modem <ID>		
dial in,out	Dial-In/Out	Sec. 35.3.6
address 10.1.0.1	Default Local IP	Sec. 35.3.12
remote-address 10.1.0.2	Default Remote IP	Sec. 35.3.13
no aaa-method	Basic	Sec. 35.3.15
ppp-advanced		
demand 600	Enabled	Sec. 35.3.18

Table 35.6: Summary of differences in *default settings* and in the split between *basic* and *advanced PPP settings* for different dial modes.

35.3.1 Managing PPPoE connections

Syntax [no] pppoe <ID>

Context [Global Configuration](#) context

Usage Enter the PPPoE Configuration context of the given PPPoE instance ID. If this is a new PPPoE instance, the PPP instance will be created first upon leaving the PPP context with *end* or *leave*. An associated network interface *pppoe<ID>* (e.g., *pppoe0*) will be created (see [chapter 22](#)).

Use "**no pppoe <ID>**" to remove an existing PPP instance, or **no pppoe** to remove all PPP instances.

As of WeOS v4.33.0 only a single PPPoE instance (ID "0") is supported.

Default values Not applicable.

35.3.2 PPPoE VLAN Interface Setting

Syntax [no] iface <IFNAME>

Context [PPPoE Configuration](#) context

Usage Set the (VLAN) network interface where this PPPoE instance should operate, e.g., "**iface vlan10**".

Use "**show iface**" to check the interface setting for this PPPoE instance.

Default values None defined

35.3.3 PPPoE Service Name

Syntax [no] service-name <SERVICE-NAME>

Context [PPPoE Configuration](#) context

Usage ISP name or a class of service configured on PPP.

Use "**show service-name**" to check the service name setting for this PPPoE instance.

Default values Disabled ("**no service-name**")

35.3.4 PPP Modem: Managing PPP over Serial Port and Modem

Syntax [no] modem <ID>

Context [Global Configuration](#) context

Usage Enter the PPP Modem Configuration context of the given modem instance ID (defaults to ID "0"). If this is a new modem instance, the modem instance will be created first upon leaving the modem context with *end* or *leave*. An associated network interface *modem<ID>* (e.g., *modem0*) will be created (see [chapter 22](#)).

Use "**no modem <ID>**" to remove an existing modem instance, or **no modem** to remove all modem instances.

As of WeOS v4.33.0 only a single modem instance (ID "0") is supported.

Default values Not applicable.

35.3.5 PPP Modem Serial Port

Syntax [no] port <PORT>

Context [PPP Modem Configuration](#) context

Usage Serial port connected to external modem or null modem cable.

Use "**show port**" to view which port will be used for communication.

Default values The first (lexicographically) enabled and available port will be chosen when creating a new modem instance. If there are no eligible ports, it will be disabled ("**no port**").

35.3.6 PPP Modem Dial Mode

Syntax [no] dial <in out>

Context [PPP Modem Configuration](#) context

Usage Dial mode with external modem or null modem mode.

- "**no dial**": Null modem mode.
- "**dial in**": Dial-in. WeOS will respond to incoming calls.
- "**dial out**": Dial-out. WeOS will initiate outgoing calls.
- "**dial in out**": Combined dial-in/out. WeOS will be able to respond to incoming calls and initiate outgoing calls.

Use "**show dial**" to view the current dial mode.

Default values Null modem ("no dial").

35.3.7 PPP Modem Initialisation String

Syntax [no] init-string <AT-CMD>

Context [PPP Modem Configuration](#) context

Usage AT command sequence used to initialise an external modem.

This option is only available when using an external modem, it is not applicable in a null modem setup.

Use "**show init-string**" to view the current initialisation string.

Default values ATE0Q0V1&C1&S0S0=0&W

35.3.8 PPP Modem Dial String

Syntax [no] dial-string <AT-CMD>

Context [PPP Modem Configuration](#) context

Usage AT command sequence used to make an outgoing call.

This option is only available when acting as an initiator, making outgoing calls using an external modem. In other words when dial mode is one of "dial out" or "dial in out".

Use "**show dial-string**" to view the current dial string.

Default values ATD

35.3.9 PPP Enable

Syntax [no] enable

Context Generic PPP setting ([PPPoE Configuration](#) and [PPP Modem Configuration](#) contexts)

Usage Enable, or disable this PPP link.

Use "**show enable**" to check if this PPP instance is enabled or not.

Default values Enabled

35.3.10 PPP Credentials (Username and Password)

Syntax [no] identity <USERNAME> password <PASSWORD>

Context Generic PPP setting ([PPPoE Configuration](#) and [PPP Modem Configuration](#) contexts)

Usage PPP credentials, i.e., your username and password for the PPP connection. This information is used to authenticate you to the peer end of the PPP connection, typically your ISP.

(For information on how to authenticate your peer, see [Sec. 35.3.15.](#))

Default values Disabled ("no identity")

35.3.11 PPP Advanced Context

Syntax [no] ppp-advanced

Context Generic PPP setting ([PPPoE Configuration](#) and [PPP Modem Configuration](#) contexts)

Usage Enter the PPP Advanced Configuration context. This contexts holds all PPP settings applicable for this type of PPP context, while only the most common settings are available in the generic [PPPoE Configuration](#) and [PPP Modem Configuration](#) contexts) above. See [tables 35.3-35.6](#) for more information.

35.3.12 PPP Local Address Setting

Syntax [no] address <ADDRESS>

Context Generic PPP setting ([PPPoE Configuration](#) and [PPP Modem Configuration](#) contexts)

Usage Set the local IP address for this PPP link.

Use "**show address**" to view the currently set address.

Default values Based on the link type and ID, for more details see [section 35.1.7.](#)

35.3.13 PPP Remote/Peer Address Setting

Syntax [no] remote-address <ADDRESS>

Context [PPP Advanced Configuration](#) context (also as generic PPP setting in [PPP Modem Configuration](#) context)

Usage Set the remote/peer IP address for this PPP link.

Use **"show address"** to view the currently set address.

Default values Based on the link type and ID, for more details see [section 35.1.7](#).

35.3.14 PPP Authentication Protocols

Syntax [no] auth-proto <pap chap mschap mschap-v2 | auto>

Context [PPP Advanced Configuration](#) context

Usage Specify the allowed authentication protocols.

Use **"show auth-proto"** to view the currently allowed protocols.

Default values Auto, see [section 35.1.5](#) for more details.

Example

Example

```
# only accept/agree to use pap
example:/config/pppoe-0/ppp-advanced/#> auth-proto pap
example:/config/pppoe-0/ppp-advanced/#>

# accept/agree to use pap or chap
example:/config/pppoe-0/ppp-advanced/#> auth-proto pap chap
example:/config/pppoe-0/ppp-advanced/#>
```

35.3.15 PPP Peer Authentication Method

Syntax [no] aaa-method local-db <ID>

Context [PPP Advanced Configuration](#) context (also as generic PPP setting in [PPP Modem Configuration](#) context for *dial-in* and *dial-in/out* modes).

Usage Specify the method used for peer authentication.

WeOS supports using local user databases for peer authentication. To create a local database see [section 9.1.1.2](#).

Use **"show aaa-method"** to view the currently used peer authentication.

Default values Disabled.

35.3.16 PPP MPPE Crypto Settings

Syntax [no] crypto <mppe-40 | mppe-128>

Context [PPP Advanced Configuration](#) context

Usage Set the PPP link encryption.

Must only be used in combination with a one-way authenticated connection using some form of CHAP authentication (CHAP/MS-CHAP/MS-CHAPv2). See [section 35.1.6](#) for more information.

Use **"show crypto"** to view the currently set encryption.

Default values Disabled.

35.3.17 PPP Proxy-ARP Settings

Syntax [no] proxy-arp

Context [PPP Advanced Configuration](#) context

Usage Enable or disable proxy ARP for this PPP link.

When **"proxy-arp"** is enabled, WeOS will proxy ARP requests for the peer's address under the following conditions:

- The peer has an address that belongs to the same subnet as the interface on which the ARP request is received.
- The aforementioned interface is up at the time when the PPP link is established.

Use **"show proxy-arp"** to view the current setting.

Default values Enabled.

35.3.18 PPP Dial-on-demand

Syntax [no] demand <IDLE-TIMEOUT>

Context [PPP Advanced Configuration](#) context

Usage Dial-on-demand, disconnect after idle timeout in seconds.

Use **"show demand"** to check the dial-on-demand setting for this PPP instance.

Default values Disabled ("no demand")

35.3.19 PPP MRU

Syntax [no] mru

Context PPP Advanced Configuration context

Usage Enable maximum receive unit (MRU) negotiation.

If enabled, MRU parameters will be negotiated with the peer during the PPP link establishment phase.

The unit will use the PPP interface MTU value (configured or automatic) as the MRU presented to the peer.

A received MRU parameter from the peer will be acknowledged. The PPP interface MTU will be set in run-time to the lowest of the MTU value and the received MRU value.

See chapter 22 for information about MTU.

Use "**no mru**" to disable the MRU negotiation. No MRU parameter will be sent to the peer during the PPP link establishment phase, and any MRU parameter received from the peer will be rejected.

Use "**show mru**" to check the MRU setting for this PPP instance.

Default values Enabled ("mru")

Chapter 36

GRE tunnels

WeOS supports Generic Routing Encapsulation (GRE) tunnels for IP over IP encapsulation. This chapter describes GRE tunnelling support in WeOS, while information on IP related settings of GRE interfaces is found in [chapter 22](#).

36.1 Overview of GRE tunnel Properties and Management Features

Feature	Web	CLI	General Description
<u>GRE Configuration</u>			
Enable/disable GRE tunnel	X	X	
Tunnel Endpoints	X	X	Sections 36.1.1, 36.1.2
Tunnel TTL	X	X	Section 36.1.3
Outbound Interface	X	X	Section 36.1.4
<u>GRE Status</u>			
Show GRE Tunnel Status		X	

36.1.1 Introduction to GRE tunnels

GRE is an encapsulation method for tunnelling data packets over the IP protocol, and is specified in RFC 2784[8]. GRE can encapsulate arbitrary data packets, but the most common use is to encapsulate IP packets, creating an *IP over IP* tunnel. WeOS only supports the encapsulation of IP packets in GRE.

GRE works by adding a special (GRE) header in front of the encapsulated packet containing a checksum¹, payload type (0x800 for IP) and some flags. The GRE header is preceded by an *outer* IP header used to route the packet between the tunnelling endpoints.

The GRE protocol is stateless. It does not provide any security features at all; it lacks encryption and authentication, and it does not detect lost packets, replay attacks or other spoof attacks.

You can add security, if needed, by using GRE within an IPsec VPN tunnel ([chapter 37](#)) or by using some kind of secure protocol (such as HTTPS or SSH) for the data routed through the tunnel.

GRE tunnels are configured in two steps. First you need to define the tunnel with its endpoints and other related settings (described further [sections 36.1.2-36.1.4](#)). By configuring the tunnel, a new (GRE) network interface is created automatically. The second step is to configure the created GRE interface. See [chapter 22](#) for information about configuring interfaces, including the *GRE interfaces*.

36.1.2 Defining GRE tunnel endpoints

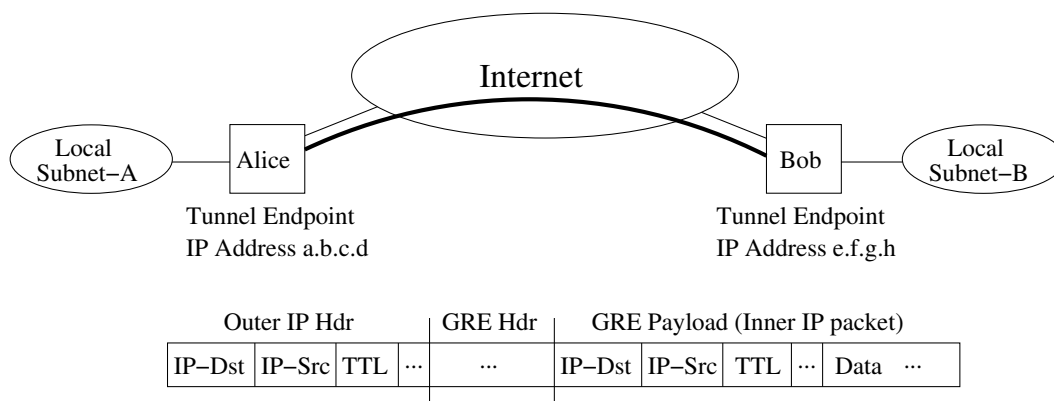

Figure 36.1: GRE tunnel example.

[Fig. 36.1](#) shows a GRE tunnel example. The IP addresses in the *outer* IP header are the tunnel endpoints (*a.b.c.d* and *e.f.g.h*). The selection of IP addresses when defining GRE tunnel endpoints depends on the use case. Two common examples are described further in this section:

¹The GRE checksum is optional. WeOS does not include a checksum in transmitted GRE packets

- *Generic use of GRE tunnels:* GRE can be used as a generic *IP-in-IP* tunnel. E.g., if Alice and Bob are NAT gateways, a GRE tunnel can be used to tunnel traffic between the local subnets (subnet-A and subnet-B.) The GRE tunnel endpoints (*a.b.c.d* and *e.f.g.h*) should be routeable IP addresses, and would typically be the public addresses of Alice and Bob (i.e., the Alice's and Bob's IP addresses on their respective interface towards the Internet).
- *Using GRE together with IPsec:* GRE can be used together with IPsec to enable an IPsec VPN to carry dynamic routing protocols such as OSPF. This enables the creation of robust IPsec VPNs capable of automatic failover to a redundant path if one connection fails. As of WeOS v4.33.0 redundant VPN solutions can be achieved by running two VPN gateways (IPsec, GRE, and OSPF) at each site as shown in [fig. 36.2](#).

In this case the IP addresses used for GRE tunnel endpoints should not be publicly routeable. Instead the IP address *a.b.c.d'* used by Alice1 would typically be an address within local subnet-A. To avoid problems when the local interface goes up/down, Alice1 could assign IP address *a.b.c.d'* as a secondary address to her loopback interface.

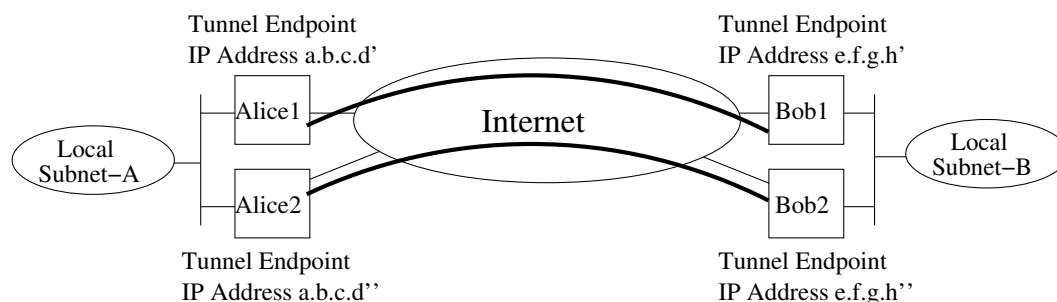

Figure 36.2: Redundant VPN solutions can be achieved by running two VPN gateways (IPsec/GRE/OSPF) at each site.

36.1.3 TTL of outer IP header

The TTL of the outer IP header (see [fig. 36.1](#)) is by default set equal to the TTL of the IP packet carried inside. It is possible to configure a specific TTL for the outer header for each GRE tunnel.

36.1.4 Restricting outbound interface for GRE traffic

By default, GRE traffic will be sent out through the interface leading towards the remote tunnel endpoint. The outbound interface is then selected on a per-packet basis by consulting the routing table (just like any other IP packet). It is also possible to configure the GRE tunnel to only allow traffic to go out via a specific network interface.

36.2 Managing GRE settings via the web interface

Menu path: Configuration ⇒ VPN & Tunnel ⇒ GRE

The main GRE configuration page lists the currently configured GRE instances.

GRE Tunnel

Instance	Enabled	Local IP	Remote IP	Outbound	Fixed TTL	
1		192.168.7.89	192.168.4.28	vlan1	48	
2		192.168.2.89	192.168.4.48	Default Gateway	Inherit	

[New](#)

Instance	A unique instance identifier for the GRE tunnel.
Enabled	In the overview table, a green check-box indicates the GRE tunnel is enabled, and a dash indicates disabled.
Local IP	The IP address assigned to the local endpoint of the GRE tunnel.
Remote IP	The IP address assigned to the remote endpoint of the GRE tunnel.
Outbound	The interface that will be used to send/receive GRE packets for this tunnel.
Fixed TTL	The TTL (Time to Live) to set on packets sent. If Inherit, the TTL value of the outbound interface will be used. Otherwise (No Inherit), the TTL value has to be assigned.
Edit	Click this icon to edit a GRE instance.
Delete	Click this icon to remove a GRE instance. You will be asked to acknowledge the removal before it is actually executed.
New	Click this button to create a new GRE instance.

36.2.1 Create a new GRE instance using the web interface

Menu path: Configuration ⇒ VPN & Tunnel ⇒ GRE ⇒ New

GRE - New Tunnel

Instance ID	<input type="text" value="1"/>
Enabled	<input checked="" type="checkbox"/>
Local IP Address	<input type="text" value="192.168.7.89"/>
Remote IP Address	<input type="text" value="192.168.4.28"/>
Fixed TTL	<input type="text" value="No Inherit"/> <input type="text" value="48"/>
Outbound Interface	<input type="text" value="vlan1"/>

For description of fields, see [section 36.2](#).

36.2.2 Edit GRE settings using the web interface

Menu path: Configuration ⇒ VPN & Tunnel ⇒ GRE ⇒ 

For description of fields, see [section 36.2](#).

The Instance ID cannot be changed after creation.

36.3 Managing GRE settings via the CLI

The table below shows GRE management features available via the CLI.

Command	Default	Section
<u>Configure GRE settings</u>		
tunnel		Section 37.3.1
[no] gre <ID>		Section 36.3.1
[no] enable	Enabled	Section 36.3.2
[no] local <IPADDR>	Empty	Section 36.3.3
[no] remote <IPADDR>	Empty	Section 36.3.4
[no] outbound <IFNAME>	Auto	Section 36.3.5
[no] ttl <TTL>	Auto	Section 36.3.6
<u>Show GRE Status</u>		
show tunnel gre [ID]		Section 36.3.7

36.3.1 Managing GRE tunnels

Syntax [no] gre <ID> where ID is a number greater or equal to 1

Context [Tunnel Configuration](#) context

Usage Create, delete, or modify a GRE tunnel.

Use **"gre <ID>"** to create a new GRE tunnel, or to enter the GRE Tunnel Configuration context of an existing GRE tunnel. The ID affects the name of the interface created for this tunnel. Example: ID as 1 will create an interface named "gre1".

Use **"no gre <ID>"** to remove a specific GRE tunnel, or **"no gre"** to remove all configured GRE tunnels. This will also remove the corresponding interfaces AND their configurations!

Use **"show [gre [ID]]"** command within the [Tunnel Configuration](#) context. Also available as **"show"** command within the GRE Tunnel Configuration context, and as **"show tunnel [gre [ID]]"** within the Global Configuration context.

Default values Not applicable.

36.3.2 Enable/disable a GRE tunnel

Syntax [no] enable

Context [GRE Tunnel Configuration](#) context

Usage Enable, or disable this GRE tunnel.

Use **"enable"** to enable and **"no enable"** to disable a GRE tunnel.

Use **"show enable"** to show whether this GRE tunnel is enabled or disabled.

Default values Enabled

36.3.3 Local endpoint IP

Syntax [no] local <IPADDR>

Context [GRE Tunnel Configuration](#) context

Usage Set the local endpoint IP for the GRE packets in this tunnel.

This IP together with the remote endpoint IP will be used for the outer GRE packets carrying the tunnelled traffic. Data going out through the tunnel from this node will be encapsulated in a GRE datagram using the local IP as source IP and the remote IP as destination IP. Incoming GRE datagrams with destination IP matching local IP and the source IP matching remote IP will be considered belonging to this GRE tunnel.

Use **"show local"** to show the configured local endpoint IP for this tunnel.

Default values None

36.3.4 Remote endpoint IP

Syntax [no] remote <IPADDR>

Context [GRE Tunnel Configuration](#) context

Usage Set the remote endpoint IP for the GRE packets in this tunnel.

This setting is used together with the local endpoint IP to specify the outer GRE packets. More info in [section 36.3.3](#).

Use **"show remote"** to show the configured remote endpoint IP for this tunnel.

Default values None

36.3.5 Outbound interface

Syntax [no] outbound <IFNAME>

Context GRE Tunnel Configuration context

Usage Set the outbound interface of this tunnel.

Use this to set a specific interface that will be used for sending and receiving the GRE packets for this tunnel instance.

Use **"no outbound"** to automatically select the interface leading to the *default gateway* as outbound interface.

Use **"show outbound"** to show the configured outbound interface for this tunnel. **"Default Gateway"** is shown if the interface leading to the default gateway should be used as outbound interface.

Default values Auto (**"no outbound"**)

36.3.6 Time to Live setting

Syntax [no] ttl <TTL>

Context GRE Tunnel Configuration context

Usage Set the Time to Live parameter for the GRE packets

Use this to set a specific Time to Live (TTL) value that will be used in the IP header for the outbound GRE packets for this tunnel instance.

Use **"no ttl"** to use the TTL defined for the interface where the GRE packets are routed out.

Use **"show ttl"** to show the configured TTL value for this tunnel.

Default values Inherit (**"no ttl"**)

36.3.7 Show GRE Tunnel Status

Syntax show tunnel gre [ID]

Context Admin Exec context.

Usage Show the status for all or for a specific GRE tunnel.

Default values If no tunnel ID is specified, the status of all tunnels is shown.

Chapter 37

IPsec VPNs

WeOS provides virtual private network (VPN) support via IPsec VPNs. A WeOS switch can act as a VPN gateway in NETWORK-NETWORK and HOST-NETWORK scenarios. Configured as a VPN gateway, it can be used to securely connect branch office networks with a central office network, or to serve individual users wishing to "dial in" securely over the Internet to the central office network, with their PC connected at some remote site. The data traffic will be protected by encrypted tunnels when sent over the Internet.

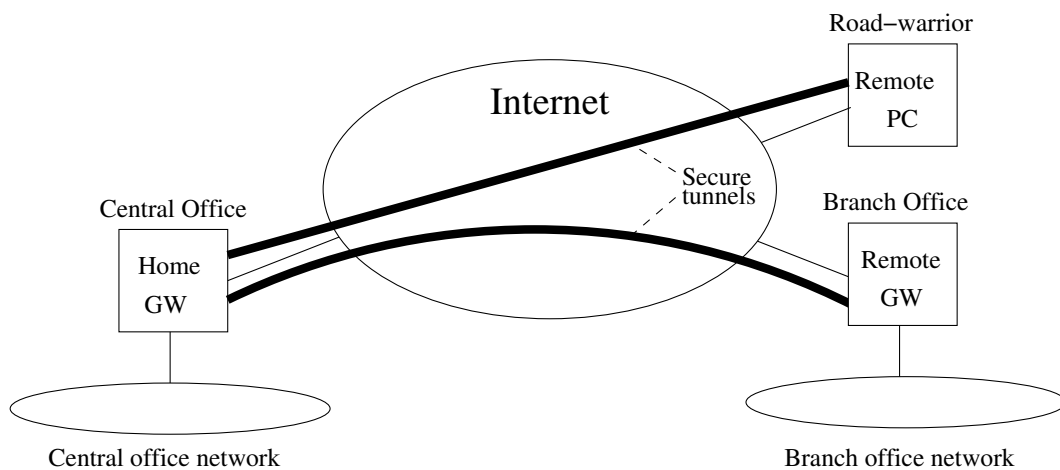

Figure 37.1: IPsec VPN tunnels can be used to securely connect hosts and networks over the Internet.

37.1 Overview of IPsec VPN Management Features

Feature	Web	CLI	General Description
<u>VPN Configuration</u>			
Add/Delete IPsec VPN tunnels	X	X	Section 37.1.1
Local/Remote Subnets	X	X	-"
Local/Remote Protocol & Port		X	
Outbound Interface	X	X	-"
NAT Traversal	X	X	-"
IKEv1	X	X	Section 37.1.3
Role (Initiator/Responder)	X	X	-"
Mode (Main/Aggressive)	X	X	Sections 37.1.3 and 37.1.7.1
IKE Authentication	X	X	Section 37.1.3
Pre-shared Key	X	X	Sections 37.1.3 and 37.1.7
Certificates	X	X	Sections 37.1.3 and 37.1.8
IKE Cipher Suite	X	X	Section 37.1.3
Identity	X	X	-"
ESP Cipher Suite	X	X	-"
Perfect Forward Secrecy	X	X	Section 37.1.4
MTU Override	X	X	Section 37.1.5
Dead Peer Detection	X	X	Section 37.1.6
<u>VPN Status</u>			
Show IPsec Tunnel Status	X	X	

37.1.1 Introduction to IPsec VPNs

A common use case for IPsec VPNs is to connect two networks via a secure tunnel over the Internet. We refer to this scenario as NETWORK-NETWORK VPNs, and is accomplished by having two VPN gateways, one at each site, negotiate and establish a secure *tunnel*, and to forward all traffic between the two networks through this tunnel. By creating VPN tunnels you establish a secure *overlay* network on top of your regular Internet connections.

We use [fig. 37.2](#) to explain some VPN related terminology.

- **Peers:** The two VPN gateways (Alice and Bob) are referred to as IPsec peers. The peers constitute the end-points of the secure tunnel. One of the peers will take the role of tunnel *initiator* and the other takes the *responder* role.

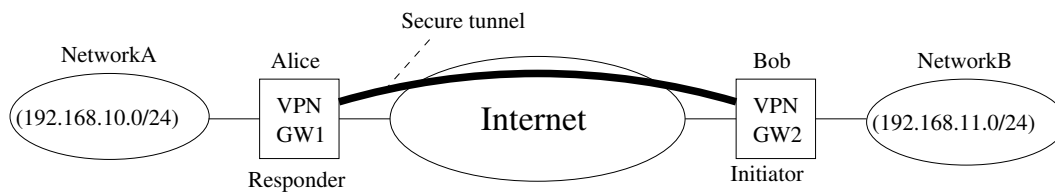

Figure 37.2: By establishing a secure IPsec Tunnel between the VPN gateways (Alice and Bob), traffic between Network-A and Network-B will be protected when sent across the Internet.

- *Initiator and Responder:* The VPN *initiator* is the peer that is responsible for initiating the tunnel establishment by contacting the other peer - the *responder*. In [fig. 37.2](#) we have assumed that Alice is the responder and Bob is the initiator.

A WeOS switch configured as a VPN gateway is able to act both as *responder* (default) and as *initiator*.

- *NAT-traversal, Peer IP addresses and DDNS:* In order to act as a responder, Alice must be assigned a *public* (routable) IP address on its interface towards the Internet. Thus, Alice generally cannot be located behind a NAT gateway, since the initiator (Bob) would not be able to initiate the tunnel. Bob will need to know Alice's IP address (or domain name) in order to know where to send the tunnel establishment messages. If Alice is assigned a fixed IP address, Bob can choose between using Alice's IP address or her domain name. But if Alice gets her address dynamically (e.g., via DHCP), Bob should use her domain name to establish the contact. WeOS supports dynamic DNS (DDNS), thus Alice can dynamically register her current IP address, see [section 22.3.3](#).

The initiator (Bob) does not need to be assigned a public IP address. Bob is able to establish the tunnel even if he is located behind a NAT gateway, given that *NAT-traversal* (NAT-T) is enabled both in Alice's and Bob's VPN configurations.

Furthermore, it is not mandatory for Alice to know Bob's IP address beforehand. It is possible to configure the VPN tunnel such that Bob could connect to the Internet at various locations and still be able to establish the VPN tunnel. This is commonly referred to as Bob being a *road warrior*.

- *Local and Remote Subnet:* Each peer will define what traffic should be allowed to pass through the established tunnel. Each peer will define the local

and remote subnet, and all traffic between these subnets is sent securely through the tunnel. To secure all traffic between networks "A" and "B", Alice would define *192.168.10.0/24* as *local subnet*, and *192.168.11.0/24* as *remote subnet* in the tunnel configuration. Bob would do the opposite, i.e., define *192.168.11.0/24* as *local subnet*, and *192.168.10.0/24* as *remote subnet*.

More advanced settings for the local and remote subnet parameters are possible, e.g., it is possible to configure the tunnel so that all traffic from Network B is sent through the tunnel (i.e., not only the traffic heading for Network A).

- *Outbound interface*: The *outbound interface* denotes the interface, and implicitly the IP address, a VPN gateway uses to tunnel the traffic through, and to communicate with its peer. In [fig. 37.2](#) Alice *outbound interface* would be her interface towards the Internet (and the same goes for Bob).

By default, the *outbound interface* is set to the interface leading to the *default gateway* (see [section 22.3](#)).

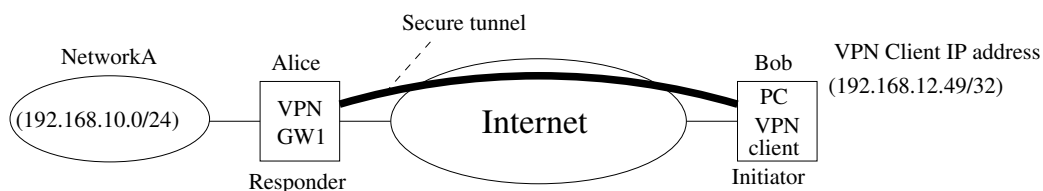

Figure 37.3: IPsec VPNs can be used to provide secure connections between individual hosts and a network behind a VPN gateway, a HOST-NETWORK VPN.

Another common use case is shown in [fig. 37.3](#). In this case Bob is an individual host, i.e., a PC with VPN client software installed. A WeOS switch is able to act as VPN gateway in HOST-NETWORK scenarios. The host (Bob) should be assigned a VPN client IP address (*192.168.12.49* in [fig. 37.3](#)), which is used to communicate with the hosts in Network-A. For Alice the configuration is very similar to the NETWORK-NETWORK example above, with the main difference being that her remote-subnet defines an individual IP address (*192.168.12.49/32*, i.e., *netmask 255.255.255.255*) instead of a network. As in the NETWORK-NETWORK use case, Bob's PC can be configured as a *road warrior* connecting from different IP addresses, and with NAT-T enabled he can connect from behind a NAT gateway.

37.1.2 IPsec instances and maximum number of IPsec sessions

A WeOS unit can be configured with up to MAX_IPSEC_INSTANCES (25) instances.

- On IPsec VPN clients (initiators) there will typically only be a single IPsec instance.
- On IPsec VPN servers (responders), the need for additional IPsec instances depends on the authentication method used, pre-shared key (PSK) or certificates, and for PSK also on the number of VPN clients to support.
 - *Certificates*: When basing IKE authentication on certificates ([section 37.1.8](#)), the VPN server is able to accept multiple VPN clients to connect via a single instance. Thus, with certificate authentication it is typically enough for the IPsec server (responder) to configure a single instance.
 - *Pre-shared key*: When basing IKE authentication on PSKs ([section 37.1.7](#)), the VPN server typically need to configure a separate IPsec instance for each connecting VPN client, at least if the clients wish to connect simultaneously.



Note

MAX_IPSEC_INSTANCES (25) is the upper limit of instances to create, which is also the upper limit of simultaneous "PSK sessions" the server can be configured for.

However, the exact number of connections the server can *handle* can be further limited of performance reasons, as it depends on the platform of your product ([section 1.5](#)), the traffic load of the established tunnels as well as the configuration of your unit.

37.1.3 Authenticated Keying using Internet Key Exchange (IKE)

As part of the IPsec VPN tunnel establishment Alice and Bob will use the IKE (Internet Key Exchange) protocol to authenticate each other and create necessary session keys to protect the data traffic. WeOS supports IKE version 1 (IKEv1) with authentication through *pre-shared keys* (PSK) or *certificates* (RSA signature keys using X.509 certificates). In IKEv1 there are two authentication handshakes (phase-1 and phase-2):

- IKE phase-1 handshake: In this document the IKE phase-1 handshake is simply referred to as the *IKE handshake*. In the IKE handshake Alice and Bob

identify themselves and use their configured PSK or certificates to authenticate each other. When configuring an IPsec tunnel, the identities of the peers should be defined. Five methods are provided:

- Distinguished name (ID_DER_ASN1_DN): (Only applicable for certificate based authentication). The distinguished name (DN) of an X.509 certificate, e.g., `"/C=US/O=ACME/CN=foobar"` can be used as identification. The DN string can also be specified in LDAP style (e.g., `"C=US, O=ACME, CN=foobar"`). The responder would typically use wild-card (e.g., `"C=US, O=ACME, CN=*"`) to allow multiple road-warriors to establish *tunnel sessions* via a single *tunnel configuration*.
- IP Address (ID_IPV4_ADDR): If the IP address of the peer is known, it can be used to identify it. When using *main mode* with PSK (*main* and *aggressive* modes are explained later in this section) this is the only option. When using IP address as IKE identity, WeOS allows you to specify either an IP address or a domain name, which is then *resolved* via DNS.
- Domain name (ID_FQDN): The identification can be specified as the domain name of the peer. When specifying *type "domain name"*, the entered identity value (e.g., `foobar.example.com`) is sent *as is*, i.e., it is **not** resolved to an IP address. Therefore, the domain name identification type could be used as a general user name, such as `foobar`.
- Email style (ID_USER_FQDN): The identification can be specified in email address style, e.g., `foobar@example.com`.
- Key identification (ID_KEY_ID): (Only applicable for PSK based authentication) With the key identification type, the identification can be entered as an opaque byte stream. As with the domain name type, the key identification type can be used to enter a general user name, such as `foobar`.

The IKE handshake also creates the necessary credentials for the following ESP handshake.

- IKE phase-2 handshake: In this document the IKE phase-2 handshake is referred to as the *ESP handshake*. In the ESP handshake the *cipher suite* for the VPN tunnel is negotiated as well as the *session keys* used to encrypt and integrity protect the data send through the tunnel.

The user can also specify whether the IKE handshake should use the *main* (default) or *aggressive* mode. Not all combinations are supported:

- Pre-shared key: With PSK authentication, either *main* or *aggressive* mode

can be used. However, due to limitations in IKEv1, PSK with main mode can only be used with IP address as identity, which in turn implies that the initiator must have a fixed IP address (no road-warrior).

- **Certificates:** As of WeOS v4.33.0, certificate based authentication is only supported in main mode.

A summary of supported combinations is shown below. *IKEv1 main mode with certificates* is recommended.

IKE Phase-1 handshake	Authentication Method	
	Certificate	Pre-shared Key
Main mode	Recommended Supports Road-warrior and fixed setups	Fixed setups No road-warrior
Aggressive mode	Not supported	Supports Road-warrior and fixed setups

Both for the IKE and ESP handshakes the user can specify which cryptographic protocols to use. The following algorithms are supported by WeOS:

- **Encryption algorithm:** Supported encryption algorithms are *3DES* and *AES* (key length 128, 192 and 256 bits).
- **Message authentication/integrity:** Supported hash algorithms for message authentication are *MD5*, *SHA-1* and *SHA-256*.
- **Diffie-Hellman groups:** Supported Diffie-Hellman groups are 1024 (DH group 2), 1536 (DH group 5), 2048 (DH group 14), 3072 (DH group 15), 4096 (DH group 16), 6144 (DH group 17) and 8192 (DH group 18).

These Diffie-Hellman key exchange groups are supported and are configurable for both IKE and ESP (for PFS) individually.

When using IKE *main* mode, Alice and Bob can be configured to automatically negotiate a suitable cipher suite. When using *aggressive* mode, Alice and Bob should be configured to use a specific cipher suite (same at both sides). When aggressive mode is selected, WeOS by default uses the suite *AES128-SHA1-DH1024*.

37.1.4 Perfect Forward Secrecy

Perfect Forward Secrecy (PFS) refers to the property that if an ESP session key is compromised, the attacker will only get access to the data protected by that

single key. Previous and later session keys will not be revealed just because that single key was compromised, thus data encrypted by those keys is still protected.

Note
This setting is not supported by all IPsec implementations. It is however recommended to have it enabled, on both sides of the connection.

PFS uses Diffie-Hellman to exchange new session keys. The Diffie-Hellman group can be automatically selected or manually configured.

PFS with automatic Diffie-Hellman group selection is enabled by default on all new tunnels.

If you are unsure what do to, you can safely disable PFS. If the IPsec daemon receives a request with PFS, it will allow it despite PFS being disabled or not.

37.1.5 Data encapsulation and encryption

IPsec specifies two modes to encapsulate the data, a *transport* and a *tunnel* mode. WeOS IPsec VPN only supports the *tunnel* mode. In the tunnel mode, the original IP packets are encapsulated within another IP packet as shown in fig. 37.4.

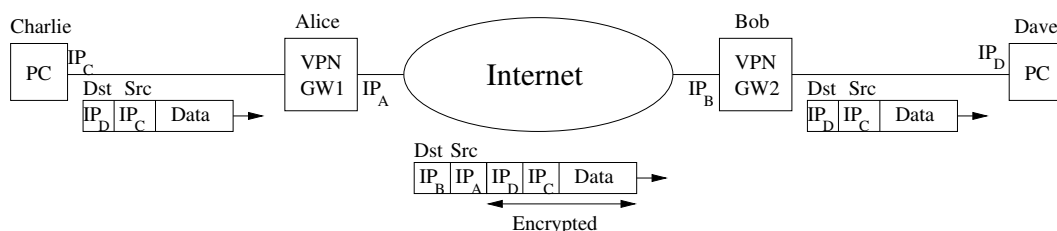

Figure 37.4: IPsec tunnel mode encapsulation. The "inner" IP header holds the original IP addresses of Charlie and Dave, and the outer IP header contains the addresses of the VPN gateways Alice and Bob.

In IPsec there is also the choice by protecting the data using AH (Authentication Header), and ESP (Encapsulating Security Payload) formats. WeOS only supports ESP, which is the format to use to achieve both data *encryption* and *integrity* protection.

In order to send encapsulated data more efficiently over the Internet an operator can tune the maximum transmission unit (MTU) for VPN tunnels. By default the MTU for VPN tunnels is set to 1419 bytes.

37.1.6 Dead Peer Detection

The connectivity through an established IPsec tunnel may be broken unexpectedly, e.g., one of the peers go down or is disconnected, or if some kind of routing, NAT or firewall problem occurs on the path between them.

Dead Peer Detection (DPD) can be used to discover and manage such situations. In DPD the peers exchange keep-alive messages to monitor if the remote peer is still reachable. If a peer determines connectivity to be broken, appropriate *actions* should be taken. There are three configuration options for the DPD action:

- *Restart*: An initiator should try to reestablish an IPsec tunnel by restarting the IKE handshake.
- *Hold*: A responder can chose the *Hold* DPD action. This is often the preferred option in a NETWORK-NETWORK VPN scenario (see [fig. 37.2](#)).
- *Clear*: A responder can also chose the *Clear* DPD action. This is the preferred option if the HOST-NETWORK VPN scenario, i.e., if the initiator is a single road warrior (see [fig. 37.3](#)), but *Clear* may also be used in a NETWORK-NETWORK VPN scenario.

As of WeOS v4.33.0 a VPN gateway configured as initiator will use DPD action *restart* by default, while a responder by default uses DPD action *clear*.

Two additional DPD parameters can be configured:

- *DPD Delay*: The DPD delay is the interval between DPD probing messages sent by a VPN gateway.
- *DPD Timeout*: If a period corresponding to the DPD timeout elapses without getting any response on the DPD probe messages, the VPN gateway considers the peer to be down.

The DPD settings can be configured individually on each peer. It is even possible to disable DPD on one of the peers - that peer will still respond to DPD probing messages from the other peer.

37.1.7 Examples of using IPsec VPN with PSK

This section illustrates configuration steps when configuring IPsec VPNs using IKE authentication with pre-shared key (PSKs).

[Fig. 37.5](#) shows a sample IPsec VPN topology which can be used to illustrate VPN configuration steps. This is the same topology as shown in the NET-NET example

in [fig. 37.2](#), but with some more details on the inbound and outbound interface of each VPN gateway.

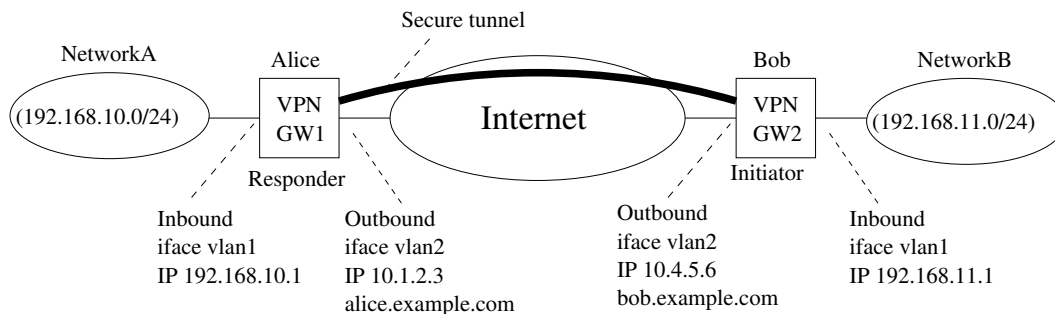

Figure 37.5: Example VPN topology used to illustrate configuration steps.

We have two VPN gateways, Alice and Bob, which are used to establish a secure VPN tunnel between the central office network (192.168.10.0/24) and the branch office network (192.168.11.0/24).

When using pre-shared key authentication, we first need to determine if Bob's outbound interface has a fixed address or not. This affects the choice of IKE *main mode* or *aggressive mode*, as discussed in [section 37.1.7.1](#). [Sections 37.1.7.2](#) and [37.1.7.3](#) explain the configuration steps if *aggressive mode* or *main mode* is used.

37.1.7.1 Selecting Aggressive or Main Mode?

An IPsec tunnel must specify whether IKE should operate in *main mode* or in *aggressive mode* (in WeOS v4.33.0 *main mode* is used by default).

As mentioned in [section 37.1.3](#), the IKE *main mode* with PSK authentication is limited to IP address as peer identification. This in turn means that IKE *aggressive mode* should be used if the *initiator's IP address is not fixed*, e.g., if Bob may change location (road warrior), or if he is using DHCP to acquire his address on the outbound interface. For a description of establishing the VPN topology in [fig. 37.5](#) with IKE *aggressive mode*, see [section 37.1.7.2](#).

On the other hand, if Bob has a fixed IP address, the setup in [fig. 37.5](#) could be established either with IKE *main mode* or *aggressive mode*. *Main mode* is somewhat simpler to configure, and is described in [section 37.1.7.3](#).

37.1.7.2 Aggressive Mode Configuration

Below you find hints on how to configure the *initiator* (Bob) and *responder* (Alice) in IKE aggressive mode. Note: this is just an example; several alternatives exist.

Many VPN settings can be configured in the same way on the *responder* (Alice) and the *initiator* (Bob):

- VPN instance number: This number is of local significance only, i.e., it can differ on Alice and Bob. In the Web configuration, it is simplest to accept the suggested value. At most 25 instances can be created.
- Enable the VPN tunnel: Yes (default)
- Outbound interface: Default gateway (or "vlan2")
- Aggressive mode: Yes
- IKE (phase-1) cipher suite: With aggressive mode, a specific cipher suite must be specified (auto-mode is not possible). Simplest is to use the default settings: AES-128 for encryption, SHA1 for authentication, and group DH 2 (1024) for the Diffie-Hellman exchange.
- Pre-shared secret: The common password, e.g., "TopSecret123!", which should be known only by Alice and Bob.
- ESP cipher suite: With aggressive mode, a specific cipher suite must be specified (auto-mode is not possible). Simplest is to use the default settings: AES-128 for encryption, SHA1 for authentication, and automatic Diffie-Hellman group (for PFS)
- Enable PFS: Yes.
- DPD Delay: 30 seconds (default)
- DPD Timeout: 120 seconds (default)

Responder specific settings (Alice):

- Remote Peer: Any (not necessary to know the IP address of Bob)
- Local subnet: 192.168.10.0; netmask: 255.255.255.0
- Remote subnet: 192.168.11.0; netmask: 255.255.255.0
- Role: Responder (no initiator)
- Local-id: Type "Name (DNS/User)", Identifier "Alice"
- Remote-id: Type "Name (DNS/User)", Identifier "Bob"

- DPD Action: Clear

Initiator specific settings (Bob):

- Remote Peer: 10.1.2.3 (or *alice.example.com*)
- Local subnet: 192.168.11.0; netmask: 255.255.255.0
- Remote subnet: 192.168.10.0; netmask: 255.255.255.0
- Role: Initiator
- Local-id: Type "Name (DNS/User)", Identifier "Bob"
- Remote-id: Type "Name (DNS/User)", Identifier "Alice"
- DPD Action: Restart

37.1.7.3 Main Mode Configuration

Below you find hints on how to configure the *initiator* (Bob) and *responder* (Alice) in IKE main mode. Note: this is just an example; several alternatives exist.

Many VPN settings can be configured in the same way on the *responder* (Alice) and the *initiator* (Bob):

- VPN instance number: This number is of local significance only, i.e., it can differ on Alice and Bob. In the Web configuration, it is simplest to accept the suggested value. At most 25 instances can be created.
- Enable the VPN tunnel: Yes (default)
- Outbound interface: Default gateway (or "vlan2")
- Aggressive mode: No (i.e., use main mode)
- IKE (phase-1) cipher suite: Auto (simplest)
- Pre-shared secret: The common password, e.g., "TopSecret123!", which should be known only by Alice and Bob.
- ESP cipher suite: Auto (simplest)
- Enable PFS: Yes.
- DPD Delay: 30 seconds (default)
- DPD Timeout: 120 seconds (default)

Responder specific settings (Alice):

- Remote Peer: 10.4.5.6 ("Any" can not be used; Domain name *bob.example.com* can not be used either.)
- Local subnet: 192.168.10.0; netmask: 255.255.255.0
- Remote subnet: 192.168.11.0; netmask: 255.255.255.0
- Role: Responder (no initiator)
- Local-id: Auto (or type "IP Address", Identifier "10.1.2.3")
- Remote-id: Auto (or type "IP Address", Identifier "10.4.5.6")
- DPD Action: Hold

Initiator specific settings (Bob):

- Remote Peer: 10.1.2.3 (or *alice.example.com*)
- Local subnet: 192.168.11.0; netmask: 255.255.255.0
- Remote subnet: 192.168.10.0; netmask: 255.255.255.0
- Role: Initiator
- Local-id: Auto (or type "IP Address", Identifier "10.4.5.6")
- Remote-id: Auto (or type "IP Address", Identifier "10.1.2.3" or "*alice.example.com*")
- DPD Action: Restart

37.1.8 Use of certificates for IKE authentication

WeOS supports IKE authentication via *certificates* and *pre-shared keys* (PSKs), with certificate based authentication as *recommended* method. While PSK based authentication can be somewhat simpler to configure, certificate based authentication is often considered more secure, and makes it easier to manage setups with multiple road-warriors.

This section provides additional hints when using certificate based authentication of IPsec tunnels in WeOS.

1. *Load/import certificates:* To use certificates for IKE based authentication you must first create/acquire certificates and private keys, and load them onto your WeOS unit(s). See [section 7.1.8](#) for more information on load-ing/importing certificates onto your WeOS unit.
2. *Use case and PKI model:* What certificates to load onto your WeOS unit will depend on your specific use case. Three common use cases supported by WeOS.
 - *Common CA:* Alice (IPsec Responder, typically a VPN Gateway), Bob (IPsec Initiator/VPN PC client or gateway) use a common CA. This would be a typical scenario when a company wish to allow their employees or branch offices to connect securely to the central office. See [section 37.1.8.1](#) for more information.
 - *Different CAs:* Alice and Bob have certificates issued by different CAs. This would be a typical scenario when you wish to communicate securely between units of different organisations. See [section 37.1.8.2](#) for more information.
 - *Trusted Peer:* Alice and Bob can import each others certificates. This approach does **not** require Alice and Bob to install each others CA certificates. In a way this case is similar to using PSKs, although a bit more secure. See [section 37.1.8.3](#) for more information.
3. *Verify/set time on unit:* As certificates are valid for a certain time period (start time and end time), it is important that the date/time is set correctly on your WeOS unit. You can set the time manually (see [chapter 8](#)), but it is recommended to use SNTP/NTP (see [sections 22.3.2, 22.5.2](#) (Web), and [??](#) (CLI)) as the date/time can be reset to Unix epoch (January 1, 1970) if left without power for some time.
4. *Defining local and remote IKE identities:* For Alice and Bob to identify each other using certificates, use of *Distinguished Name*(ID_DER_ASN1_DN) is

recommended. As stated in [section 37.1.3](#), identity methods *domain name* (ID_FQDN), *email* (ID_USER_FQDN), and *IP address* (ID_IPV4_ADDR) are possible too, but requires the specific identity to be included as *subjectAltName* in the certificate. E.g., if Bob wish to wish to identify himself as *bob@example.com* (email style), his certificate needs to include "subjectAltName=email:bob@example.com", and he should set "**local-id email bob@example.com**" in his IPsec tunnel configuration. Correspondingly, Alice would set "**remote-id email bob@example.com**" in her IPsec tunnel configuration.

For examples using *Distinguished Name* as identity, see [sections 37.1.8.1-37.1.8.3](#).

Using "auto" for the local-id setting ("**no local-id**") together with certificate based authentication means that Alice will identify herself with the *ID_DER_ASN1_DN* method, and automatically extract her DN string value from her certificate.



Warning on using "auto" mode for "remote-id"

As of WeOS v4.33.0 use of "auto" mode for "remote-id" together with certificate authentication is discouraged. That option may change behaviour or even be removed in future versions of WeOS, thus its use will pose risks when doing future upgrades. (Use of "auto" mode with PSK authentication is fine, though).

Further details: when using certificates in WeOS v4.33.0, if Alice uses "auto"-mode to identify Bob ("**no remote-id**") WeOS will expect Bob to identify himself using method:

- "ID_DER_ASN1_DN" when no peer IP address or domain name is set (she considers Bob to be a road-warrior ("**no peer**"). Furthermore, there will be no restriction on **what** DN string Bob presents as long as his certificate is valid and issued by a trusted CA.
- "ID_IPV4_ADDR" when a peer IP address or domain name is set (e.g., "**peer 1.2.3.4**"). Thus, in this case Bob would have to include the corresponding IP address in the certificate (e.g., "subjectAltName=IP:1.2.3.4") and set his local-id accordingly ("**local-id inet 1.2.3.4**").

5. *Defining local and remote IP subnets*: By using DN strings with common name (CN) wild-card, a VPN gateway can easily serve multiple road-warriors using a single IPsec tunnel. E.g., if Alice (IPsec Responder/VPN Gateway) use

DN string, *C=US, O=ACME, CN=** as remote-id, it would match certificates with different CNs (e.g., Bob or Charlie) as long as the other relative distinguished names (RDNs), here *C=US, O=ACME*, of the presented certificate would match.

However, if Alice is to allow multiple VPN peers to connect via a single tunnel definition, she should allow each peer to have a *local subnet* (or *virtual IP*) corresponding to a *part* of her configured *remote subnet*, i.e., her remote subnet should be shared by Bob, Charlie or any other valid peer. An example is shown in the figure below, where Alice has declared her remote subnet *10.0.2.0/24* as *shared* to allow Bob, Charlie and Dave to connect.

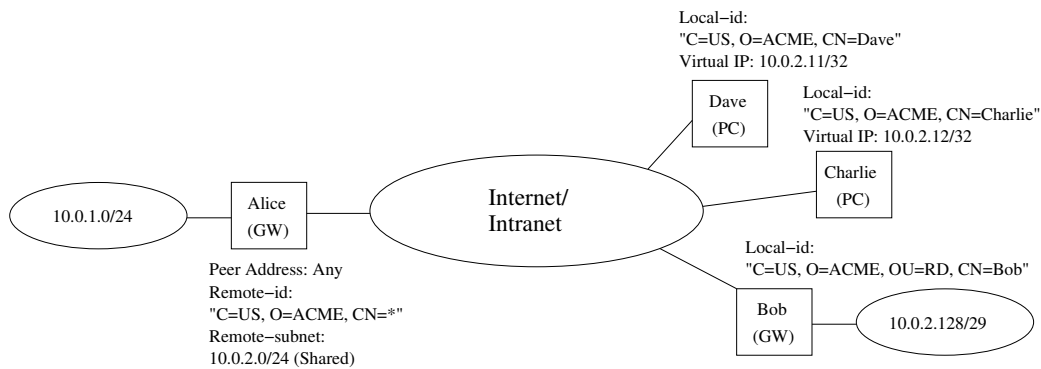

Figure 37.6: By defining the remote subnet as "shared", one IPsec tunnel definition at the responder (Alice) can serve multiple initiators (Bob, Charlie, and Dave).

37.1.8.1 Common CA: IKE certificates within an organisation

When a company wish to use IPsec with certificate authentication within their organisation, all entities (IPsec VPN gateways and users of VPN clients) can have their certificate issued by the *same* CA. The CA can either be operated by the company itself, or an external (professional) CA organisation.

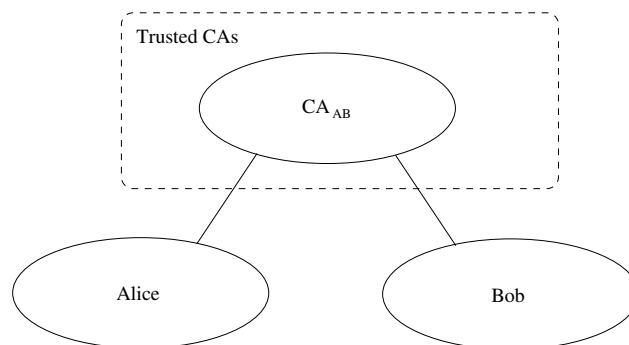

Figure 37.7: Alice and Bob have certificates issued by the same CA (e.g., their company CA). In this PKI model, Alice uploads the certificate of her CA, and trusts any certificate issued by that CA.

In this user scenario, a VPN unit such as Alice will have to upload/import

- the certificate of her CA (CA_{AB}),
- her own certificate (AliceCert), and
- the private key associated with her certificate.

This is typically done by importing a password protected *PKCS#12 bundle*, holding both these certificates and the private key (see [section 7.1.8](#) for more information on certificate management).

If we consider the sample setup in [fig. 37.6](#), the certificates of Alice, Bob, Charlie, and Dave could all be issued by the same CA. Below we see sample WeOS CLI syntax for Alice's and Bob's VPN configuration, as well as some comments.

- *Local-id*: The local-id strings are not necessary here; using the 'auto' mode ("**no local-id**") is sufficient, since the default is to use the DN string of the local certificate in certificate authentication mode is used ("**method cert**").
- *Shared remote-subnet*: As Bob's local subnet (10.0.2.128/29) only defines a subset of the remote subnet defined by Alice (10.0.2.0/24), she has added the keyword "**shared**".

- *Remote CA:* The setting "**remote-ca same**" enforces the restriction that Alice will verify that Bob's certificate is issued by the same CA as her certificate (and vice versa). This is the default setting, and may not be shown in your configuration file. See [sections 37.1.8.2](#) and [37.1.8.3](#) for alternative settings.
- *Remote Cert:* In this scenario, Alice would accept all initiators (Bob, Charlie, Dave, etc.) with a certificate issued by their common CA, and where the DN string matches "C=US, O=ACME, CN=*". The remote certificate only needs to be specified in the *trusted peer* use case, see [section 37.1.8.3](#). The default setting is "**no remote-cert**", thus this line may not be shown in your configuration file.
- *Peer IP address:* Alice is configured to accept initiators irrespective of their IP address. Bob needs to be configured with Alice's "Internet" IP address or domain name as peer (here [10.10.1.2](#); not shown in [fig. 37.6](#)).

Example

Alice's Configuration

```
tunnel
 ipsec 0
   enable
   no aggressive
   pfs
   no ike
   no esp
   no peer
   no outbound
   local-id dn "C=US, O=ACME, CN=Alice"
   remote-id dn "C=US, O=ACME, CN=*"
   local-subnet 10.0.1.0/24
   remote-subnet 10.0.2.0/24 shared
   method cert
   local-cert AliceCert
   no remote-cert
   remote-ca same
   no initiator
   dpd-action clear
   dpd-delay 30
   dpd-timeout 120
   sa-lifetime 28800
   ike-lifetime 3600
 end
end
```

Bob's Configuration

```
tunnel
 ipsec 0
   enable
   no aggressive
   pfs
   no ike
   no esp
   peer 10.10.1.2
   no outbound
   local-id dn "C=US, O=ACME, CN=Bob"
   remote-id dn "C=US, O=ACME, CN=Alice"
   local-subnet 10.0.2.128/29
   remote-subnet 10.0.1.0/24
   method cert
   local-cert BobCert
   no remote-cert
   remote-ca same
   initiator
   dpd-action restart
   dpd-delay 30
   dpd-timeout 120
   sa-lifetime 28800
   ike-lifetime 3600
 end
end
```

37.1.8.2 Different CAs: IKE certificates with multiple organisations

As of WeOS v4.33.0, this use case can only be configured via the CLI.

To use IPsec to establish secure tunnels between users or units of different organisations, Alice and Bob will usually have certificates issued by *different* CAs. In this case, Alice would upload/import Bob's CA certificate (C_B), and would thereby trust all certificates issued by Bob's CA.

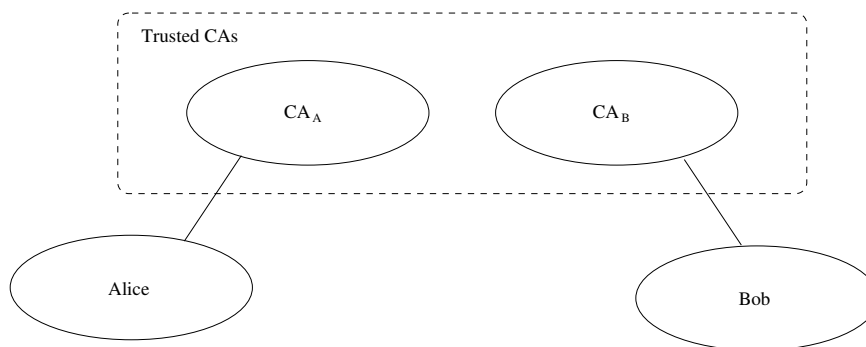

Figure 37.8: Alice and Bob have certificates issued by different CAs (e.g., their respective company CA). In this PKI model, Alice uploads the certificate of her CA (CA_A), and Bob's CA (CA_B), and trusts any certificate issued by either of them CA.

In this user scenario, a VPN unit such as Alice will have to upload/import

- the certificate of her CA (CA_A),
- the certificate of Bob's CA (CA_B),
- her own certificate (AliceCert), and
- the private key associated with her certificate.

Alice would typically upload/import her private key, her CA and own certificates as a password protected *PKCS#12 bundle*, while Bob's CA certificate could be uploaded/imported as a PEM file. See [section 7.1.8](#) for more information on certificate management).

If we consider the sample setup in [fig. 37.6](#), the certificates of Alice and Bob would now be issued by different CAs. Below we see sample WeOS CLI syntax for Alice's and Bob's VPN configuration, as well as some comments.

- *Remote CA*: The setting `"remote-ca dn 'C=US, O=FOOBAR, CN=foobarCA'"` in Alice's configuration restricts initiators to have certificates issued by the "FoobarCA" (Bob's CA). An alternative would be to use the setting `"remote-ca`

any", which would allow initiators with valid certificates issued by any CA trusted by Alice.

Correspondingly, Bob is configured to only trust certificates issued by "AcmeCA" (Alice's CA).

As of WeOS v4.33.0, the *Remote CA* setting is only configurable via the CLI, thus this use case cannot be configured via the Web interface. However, a similar service can be achieved via the *trusted peer* use case, see [section 37.1.8.3](#).

- For comments on other settings, see the related example in [section 37.1.8.1](#).

 **Example**

Alice's Configuration	Bob's Configuration
<pre>tunnel ipsec 0 enable no aggressive pfs no ike no esp no peer no outbound local-id dn "C=US, O=ACME, CN=Alice" remote-id dn "C=US, O=FOOBAR, CN=*" local-subnet 10.0.1.0/24 remote-subnet 10.0.2.0/24 shared method cert local-cert AliceCert no remote-cert remote-ca dn "C=US, O=FOOBAR, CN=foobarCA" no initiator dpd-action clear dpd-delay 30 dpd-timeout 120 sa-lifetime 28800 ike-lifetime 3600 end end</pre>	<pre>tunnel ipsec 0 enable no aggressive pfs no ike no esp peer 10.10.1.2 no outbound local-id dn "C=US, O=FOOBAR, CN=Bob" remote-id dn "C=US, O=ACME, CN=Alice" local-subnet 10.0.2.128/29 remote-subnet 10.0.1.0/24 method cert local-cert BobCert no remote-cert remote-ca dn "C=US, O=ACME, CN=AcmeCA" initiator dpd-action restart dpd-delay 30 dpd-timeout 120 sa-lifetime 28800 ike-lifetime 3600 end end</pre>

37.1.8.3 IKE with trusted peer certificates

As an alternative to installing trusted CA certificates, Alice and Bob can import each others certificates and use as *trusted peers*.

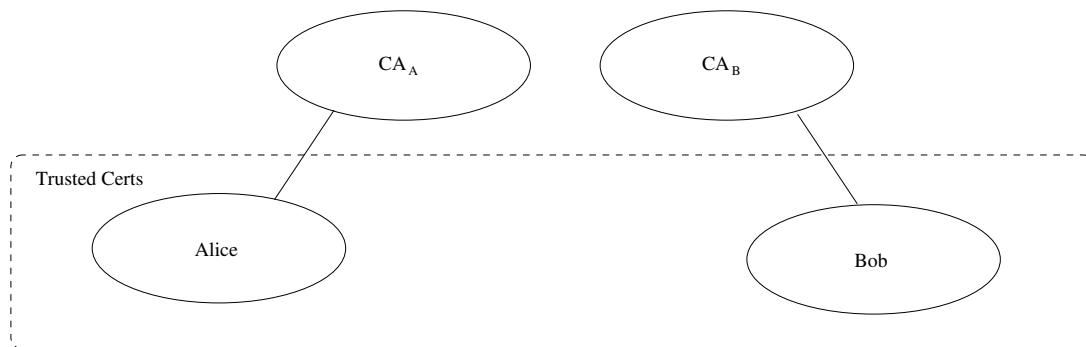

Figure 37.9: Alice and Bob have imported each others certificates as trusted peers. In this case Alice and Bob do not need to install/import CA certificates.

In this user scenario, a VPN unit such as Alice will have to upload/import

- Bob's certificate (BobCert),
- her own certificate (AliceCert), and
- the private key associated with her certificate.

In most cases Alice would also import her CA certificate (CA_A), although this is not required for this trust model. Typically she would then upload/import her private key, her CA and own certificates as a password protected *PKCS#12 bundle*, while Bob's certificate could be uploaded/imported as a PEM file. See [section 7.1.8](#) for more information on certificate management).



Note

Although this trust model does not require Alice or Bob to install any CA certificates, WeOS still requires their certificates to be issued by some CA, i.e., the *Issuer* and *Subject* of the certificate cannot be the same.

The configuration example below is loosely based on sample setup in [fig. 37.6](#). However, as this tunnel configuration is only intended for Alice and Bob, we have restricted the *remote-id* and *remote-subnet* settings on Alice side. Furthermore, we have let Alice and Bob have certificates of different CAs, to make the example more general.

- *Local-id*: Local-id could use "auto" mode ("**no local-id**"). That is simpler than defining the DN string explicitly as done below.
- *Remote-id*: As of WeOS v4.33.0, Remote-id can **not** use "auto" mode ("**no remote-id**"). That may change in future versions of WeOS.
- *Remote CA*: The *remote-ca* setting does **not** apply when a remote certificate is specified, thus is not shown in the example.



Example

Alice's Configuration

```
tunnel
 ipsec 0
   enable
   no aggressive
   pfs
   no ike
   no esp
   no peer
   no outbound
   local-id dn "C=US, O=ACME, CN=Alice"
   remote-id dn "C=US, O=FOOBAR, CN=Bob"
   local-subnet 10.0.1.0/24
   remote-subnet 10.0.2.0/29
   method cert
   local-cert AliceCert
   remote-cert BobCert
   no initiator
   dpd-action clear
   dpd-delay 30
   dpd-timeout 120
   sa-lifetime 28800
   ike-lifetime 3600
 end
end
```

Bob's Configuration

```
tunnel
 ipsec 0
   enable
   no aggressive
   pfs
   no ike
   no esp
   peer 10.10.1.2
   no outbound
   local-id dn "C=US, O=FOOBAR, CN=Bob"
   remote-id dn "C=US, O=ACME, CN=Alice"
   local-subnet 10.0.2.128/29
   remote-subnet 10.0.1.0/24
   method cert
   local-cert BobCert
   remote-cert AliceCert
   initiator
   dpd-action restart
   dpd-delay 30
   dpd-timeout 120
   sa-lifetime 28800
   ike-lifetime 3600
 end
end
```

37.2 Managing VPN settings via the web interface

37.2.1 Manage IPsec VPN via the web interface

Menu path: Configuration ⇒ VPN & Tunnel ⇒ IPsec

The main IPsec VPN configuration pages contains two parts: the top part lists general IPsec settings applying to all ports, the bottom part shows a list of currently configured IPsec tunnels.

IPsec

NAT Traversal (NAT-T)	<input type="checkbox"/>
MTU Override	<input type="text" value="1419"/>



Tunnels

ID	Enabled	Remote Peer	Peer ID	Local ID			
0	✓	Any	89.76.54...	vpn@west...	>> MORE		
1	✓	10.2.1.2	Auto	dialin@w...	>> MORE		

General IPsec settings:

NAT Traversal (NAT-T)	Enable NAT traversal support by checking the check box, disable NAT traversal support by un-checking the checkbox. The NAT-traversal setting will apply to all IPsec tunnels. NAT Traversal can cause inter-operability problems with some IPsec clients, so the default setting is disabled. However, when NAT-T is enabled it only kicks in when the server and client detects they are being NAT'ed. So in most cases it is a safe option to set.
MTU Override	Specify the maximum transfer unit for IPsec packets. The setting affects all IPsec tunnels.
Restart	Click this button to restart the IPsec daemon. All IPsec tunnels will be torn down and restarted.

The list shows currently configured IPsec tunnels, and displays some of the tunnel settings.

ID	The IPsec tunnel index. Each configured IPsec tunnel is identified by a number for maintenance purposes. This ID is of local significance only.
Enabled	A green check-mark means enabled and a dash means disabled.
Remote Peer	The IP address or domain name of the remote peer. Any is shown if the remote peer is allowed to connect from any IP address.
Peer ID	The Name/E-mail/Key/IP used for matching the identify of the remote peer. Auto is shown if any peer ID is accepted.
Local ID	The Name/E-mail/Key/IP used to identify ourselves to the remote peer. Auto means that the IP of the outbound interface is used as ID.
 More	Show the details of this tunnel by hovering the pointer over this button. This is only available if you have JavaScript enabled in your browser.
 Edit	Click this icon to edit the settings of a VPN tunnel.
 Delete	Click this icon to remove a VPN tunnel. Note: Tunnels which are not intended to be used should either be <i>deleted</i> or <i>disabled</i> (section 37.2.2).

37.2.2 Configure new IPsec tunnel via the web interface

Menu path: Configuration ⇒ VPN & Tunnel ⇒ IPsec ⇒ **New IPsec Tunnel**

When clicking the **New IPsec Tunnel** button the window to configure a new IPsec tunnel appears.

New IPsec Tunnel

Instance Number	<input type="text" value="0"/>
Enabled	<input checked="" type="checkbox"/>
Role	<input type="radio"/> Initiator <input checked="" type="radio"/> Responder

Network

Outbound Interface	<input type="text" value="Default Gateway"/>
Remote Peer	<input checked="" type="checkbox"/> Any
Local Subnet	
Address	<input type="text"/>
Netmask	<input type="text"/>
Remote Subnet	
Address	<input type="text"/>
Netmask	<input type="text"/>
Shared subnet	<input type="checkbox"/>
Dead Peer Detection	<input type="text" value="Clear"/>
DPD Delay	<input type="text" value="30"/>
DPD Timeout	<input type="text" value="120"/>

Security

Aggressive mode	<input type="checkbox"/>
IKE	<input checked="" type="checkbox"/> Auto
Authentication Method	<input type="text" value="Pre-shared key"/>
Secret (PSK)	<input type="text"/>
Local ID	
Type	<input type="text" value="Auto"/>
Peer ID	
Type	<input type="text" value="Auto"/>
ESP	<input checked="" type="checkbox"/> Auto
PFS	<input checked="" type="checkbox"/>
IKE Lifetime (s)	<input type="text" value="3600"/>
SA Lifetime (s)	<input type="text" value="28800"/>

General part:

Instance number	The IPsec tunnel index. Each configured IPsec tunnel is identified by a number for maintenance purposes. This ID is of local significance only. At most 25 instances can be created.
Enabled	A tunnel can be configured as Enabled or Disabled . Note: Tunnels which are not intended to be used should either be <i>deleted</i> (section 37.2.1) or <i>disabled</i> .
Role	Configure the VPN gateway to act as <i>Initiator</i> or <i>Responder</i> of the VPN tunnel.

Network part:

Outbound Interface	The outbound interface for this tunnel. The interface can either be stated explicitly (e.g., vlan3) or implicitly as the interface leading to the Default Gateway .
Remote Peer Any (Checkbox)	Click the Any checkbox if the remote peer can connect from any IP address. This is typically the case if the remote peer is a <i>road warrior</i> , who may use different addresses every time he/she connects. A VPN gateway should only consider setting Remote Peer to Any if it is acting as Responder (i.e., when the remote peer is acting as Initiator). Un-check the Any checkbox to specify a specific IP address (or domain name) for the remote host, see the item below.
Remote Peer Address/Name	The IP address (e.g., 1.2.3.4) or domain name (e.g., foobar.example.com) of the remote peer. This option is required if the node is acting as Initiator of the VPN tunnel. This option is only possible to set if the Any checkbox is <i>un-checked</i> .
Continued on next page	

Continued from previous page	
Local Subnet Address & Netmask	<p>The Address (e.g. 192.168.10.0) and Netmask (e.g., 255.255.255.0) define the local subnet. Only traffic from this IP range is allowed to enter the tunnel through this gateway, and traffic arriving through the tunnel is only accepted when destined to an address in this range.</p> <p>If no local subnet is specified, only traffic to/from the IP address of the Outbound Interface will be allowed through the tunnel.</p>
Remote Subnet Address & Netmask, & Shared Subnet (Checkbox)	<p>The Address (e.g. 192.168.11.0) and Netmask (e.g., 255.255.255.0) define the remote subnet. Only traffic to this IP range is allowed to enter the tunnel through this gateway, and traffic arriving through the tunnel is only accepted when destined to an address in this range.</p> <p>In case the remote peer is a PC (see fig. 37.3), specify the PC's VPN client IP address (e.g., 192.168.12.49) as Address, and 255.255.255.255 as Netmask.</p> <p>If no remote subnet is specified, only traffic to/from the IP address of the Remote Peer will be allowed through the tunnel.</p> <p>On a <i>responder</i>, you can specify that the remote subnet configured is <i>shared</i> by multiple initiators by setting the Shared subnet checkbox. The local subnet of each initiator must be within the range specified by the responder's remote subnet. By un-checking the Shared subnet, there can only be one initiator for this tunnel configuration, and its local subnet must match the responder's remote subnet.</p>
Dead Peer Detection	<p>The DPD Action. The DPD action defines how the VPN gateway should react when the peer is determined to be unreachable (i.e., "dead").</p>
DPD Delay	<p>The DPD delay is the interval between DPD probing messages sent by this VPN gateway. (The DPD delay setting on the two peers are independent, thus they may differ.)</p>
DPD Timeout	<p>If a period corresponding to the DPD timeout elapses without getting any response on the DPD probe messages, the VPN gateway considers the peer to be down.</p>

Security part:

Aggressive Mode	Configure whether this VPN tunnel should use <i>aggressive</i> or <i>main</i> mode for the IKE handshake. Checking the Aggressive mode checkbox specifies use of <i>aggressive</i> mode; un-checking the checkbox means specifies use of <i>main</i> mode. For Certificate based authentication, only <i>main</i> mode can be used. For PSK either <i>main</i> or <i>aggressive</i> mode can be used.
IKE Auto (Checkbox)	The cipher suite to use for the IKE handshake can either be negotiated automatically between the peers, or a specific suite can be configured manually. Check the Auto checkbox to specify cipher auto-negotiation; un-check the checkbox to specify an IKE cipher suite manually (see below). Note: Cipher auto-negotiation is only valid with main mode IKE. In case of aggressive mode, a specific IKE cipher suite must be configured (see below).
IKE Encryption, Authentication & DH-Group	Configure the encryption algorithm, message authentication algorithm and Diffie-Hellman group to use for the IKE handshake. This option is only possible to set if the IKE Auto checkbox is <i>un-checked</i> .
Authentication Method	Select between PSK and Certificate based IKE authentication.
Secret	The pre-shared secret (PSK) password string used to protect the IKE handshake. The password string should consist of at least 8 characters and at most 63 characters. Valid characters are ASCII characters 33-126, except '#' (ASCII 35).
Local Certificate	Label of local certificate (and associated private key). Mandatory when IKE authentication is based on certificates.
Remote Certificate	Label of remote (peer) certificate. Only used for <i>trusted peer</i> scenarios, see section 37.1.8.3 .
Continued on next page	

Continued from previous page	
Local ID Type & ID	<p>The identity used by the VPN gateway during the IKE handshake. Typically the Name(DNS/User) type with a simple ID text string (e.g., alice) can be used to identify the VPN gateway.</p> <p>For more details on available identification types and ID values, see section 37.1.3.</p> <p>If Auto is selected, the local-id will be of type IP Address (for PSK authentication), using the IP address of the specified Outbound interface as identity. For certificate authentication, Auto implies a local-id of type Distinguished Name, using the subject string of the local certificate as identity.</p>
Peer ID Type & ID	<p>The identity used by the peer VPN gateway during the IKE handshake. Typically the Name(DNS/User) type with a simple ID text string (e.g., bob) can be used to identify the peer VPN gateway.</p> <p>For more details on available identification types and ID values, see section 37.1.3.</p> <p>If Auto is selected, the Peer ID will be of type IP Address (for PSK authentication), using the IP address from the Remote Peer Address/Name field as identity (a domain name will be resolved to an IP address). For certificate authentication, Auto is discouraged for the Peer ID, see section 37.1.8 for details.</p>
ESP Auto (Checkbox)	<p>The cipher suite to use for the ESP handshake can either be negotiated automatically between the peers, or a specific suite can be configured manually. Check the Auto checkbox to specify cipher auto-negotiation; uncheck the checkbox to specify an ESP cipher suite and Diffie-Hellman group manually (see below).</p> <p>Note: ESP cipher auto-negotiation is only valid with main mode IKE. In case of aggressive mode, a specific ESP cipher suite must be configured (see below).</p>
Continued on next page	

Continued from previous page

ESP Encryption, Authentication & DH-Group	Configure the encryption algorithm, message authentication algorithm, and the Diffie-Hellman group to use for the ESP handshake and PFS. This option is only possible to set if the ESP Auto checkbox is <i>un-checked</i> .
PFS	Enable the Perfect Forward Secrecy (PFS) extension. PFS uses Diffie-Hellman for key exchange. The DH group is configured together with the ESP settings.
IKE Lifetime(s)	The maximum lifetime of the IKE (Phase 1) SA in seconds. Default is 3600 (1h).
SE Lifetime(s)	The maximum lifetime of the ESP (Phase 2) SA in seconds. Default is 28800 (8h).

37.2.3 Edit existing IPsec tunnel via the web interface

Menu path: Configuration ⇒ VPN & Tunnel ⇒ IPsec ⇒  (IPsec Tunnel)

By clicking the **Edit** button in the list of IPsec tunnels, you reach the **Edit IPsec Tunnel** page, as shown below.

Edit IPsec Tunnel 0

Instance Number	0
Enabled	<input checked="" type="checkbox"/>
Role	<input type="radio"/> Initiator <input checked="" type="radio"/> Responder

Network

Outbound Interface	Default Gateway
Remote Peer	<input checked="" type="checkbox"/> Any
Local Subnet	
Address	192.168.10.0
Netmask	255.255.255.0
Remote Subnet	
Address	192.168.12.0
Netmask	255.255.255.0
Shared subnet	<input type="checkbox"/>
Dead Peer Detection	Clear
DPD Delay	30
DPD Timeout	120

Security

Aggressive mode	<input type="checkbox"/>
IKE	<input type="checkbox"/> Auto
Encryption	AES128
Authentication	SHA1
DH-Group	DH 2 (1024)
Authentication Method	Pre-shared key
Secret (PSK)	••••••••
Local ID	
Type	Email
ID	vpn@westermo.se
Peer ID	
Type	IP (Address/DNS)
ID	89.76.54.32
ESP	<input type="checkbox"/> Auto
Encryption	AES128
Authentication	SHA1
DH-Group	Auto
PFS	<input checked="" type="checkbox"/>
IKE Lifetime (s)	3600
SA Lifetime (s)	28800



For information on the available configuration items, see [section 37.2.2](#).

37.2.4 View IPsec Tunnel Status

Menu path: Status ⇒ VPN & Tunnel ⇒ IPsec

The **VPN Status** page lists the status of configured IPsec tunnels.

VPN Status

ID	Enabled	Remote Peer	Peer ID	Local ID	Status	Details
0	✓	Any	89.76.54...	vpn@west...	Up	» MORE 
1	✓	10.2.1.2	Auto	dialin@w...	Down (Phase1 failed/incomplete)	» MORE 

Auto refresh: Off, [5s](#), [15s](#), [30s](#), [60s](#)

[Refresh](#)

Click the **Details** symbol  for a specific tunnel to see more verbose status information.

VPN Status - Tunnel0

```
"ipsec0": 192.168.2.210...192.168.2.230<192.168.2.230>; erouted; eroute owner: #2
"ipsec0": myip=unset; hisip=unset;
"ipsec0": ike_life: 3600s; ipsec_life: 28800s; rekey_margin: 540s; rekey_fuzz: 100%; keyingtries: 0
"ipsec0": policy: PSK+ENCRYPT+TUNNEL+PFS+UP+IKEv2ALLOW+SAREFTRACK+IKOD+rKOD; prio: 32,32; interface:
vlan1;
"ipsec0": network params: metric:0; mtu:1419;
"ipsec0": dpd: action:restart_by_peer; delay:30; timeout:120;
"ipsec0": newest ISAKMP SA: #1; newest IPsec SA: #2;
"ipsec0": IKE algorithm newest: AES_CBC_128-SHA1-MODP2048
#2: "ipsec0":500 STATE_QUICK_I2 (sent QI2, IPsec SA established); EVENT_SA_REPLACE in 27923s; newest IPSEC;
eroute owner; isakmp#1; idle; import:admin initiate
#2: "ipsec0" esp.c46cd4f0@192.168.2.230 esp.a465a979@192.168.2.210 tun.0@192.168.2.230 tun.0@192.168.2.210
ref=0 reffim=4294901761
#1: "ipsec0":500 STATE_MAIN_I4 (ISAKMP SA established); EVENT_SA_REPLACE in 2453s; newest ISAKMP;
lastdpd=19s(seq in:0 out:0); idle; import:admin initiate
```

Auto refresh: Off, [5s](#), [15s](#), [30s](#), [60s](#)

[Refresh](#)

Configured settings can also be seen by hovering the pointer over the **More** button [» MORE](#) (you need JavaScript enabled in your browser to see this information).

37.3 Managing VPN settings via the CLI

The table below shows VPN management features available via the CLI.

Command	Default	Section
<u>Configure VPN Settings</u>		
tunnel		Section 37.3.1
[no] ipsec-nat-traversal	Disabled	Section 37.3.2
[no] ipsec-mtu-override <BYTES>	1419	Section 37.3.3
[no] ipsec <INDEX>		Section 37.3.4
[no] enable	Enabled	Section 37.3.5
[no] aggressive	Main mode	Section 37.3.6
[no] pfs	Enabled	Section 37.3.7
[no] ike crypto <3des aes128 ... >	Auto	Section 37.3.8
auth <md5 sha1 sha256>		
dh <1024 ... >		
[no] esp crypto <3des aes128 ... >	Auto	Section 37.3.9
auth <md5 sha1 sha256>		
dh <auto ... >		
[no] method <psk cert>	PSK	Section 37.3.10
[no] secret <PASSWORD>	Empty	Section 37.3.11
[no] local-cert <LABEL>	Disabled	Section 37.3.12
[no] remote-cert <LABEL>	Disabled	Section 37.3.13
[no] remote-ca <same any	Same	Section 37.3.14
dn <DNSTRING>>		
[no] peer <IPADDR FQDN>	Any	Section 37.3.15
[no] outbound <IFACE>	Auto	Section 37.3.16
[no] local-id	Auto	Section 37.3.17
<inet <IPADDR DOMAIN>		
name <DOMAIN USER>		
email <USER@DOMAIN>		
key <ID> dn <DNSTRING>>		
[no] remote-id	Auto	Section 37.3.18
<inet <IPADDR DOMAIN>		
name <DOMAIN USER>		
email <USER@DOMAIN>		
key <ID> dn <DNSTRING>>		

Continued on next page

Continued from previous page		
Command	Default	Section
[no] local-subnet <SUBNET/LEN SUBNET NETMASK>	Auto	Section 37.3.19
[no] remote-subnet <SUBNET/LEN SUBNET NETMASK> [shared]	Auto	Section 37.3.20
[no] local-protocol <PROTO> [port <PORT>]	Disabled	Section 37.3.21
[no] remote-protocol <PROTO> [port <PORT>]	Disabled	Section 37.3.22
[no] initiator	Responder	Section 37.3.23
[no] dpd-action <clear hold restart>	Clear/Restart	Section 37.3.24
[no] dpd-delay <SECONDS>	30	Section 37.3.25
[no] dpd-timeout <SECONDS>	120	Section 37.3.26
[no] ike-lifetime <SECONDS[s] ... >	1h	Section 37.3.27
[no] sa-lifetime <SECONDS[s] ... >	8h	Section 37.3.28
Show VPN Status		
show tunnel ipsec [ID]		Section 37.3.29

37.3.1 Managing Tunnels

Syntax tunnel

Context [Global Configuration](#) context

Usage Use the **"tunnel"** command to enter the Tunnel Configuration context.

Use **"show tunnel"** to list configured VPN tunnels (also available as **"show"** command within the Tunnel Configuration context).

Default values Not applicable.

37.3.2 Enable/disable IPsec NAT Traversal

Syntax [no] ipsec-nat-traversal

Context [Tunnel Configuration](#) context

Usage Enable or disable NAT-T for *all* IPsec tunnels. NAT Traversal can cause inter-operability problems with some IPsec clients, so the default setting is disabled.

However, when NAT-T is enabled it only kicks in when the server and client detects they are being NAT'ed. So in most cases it is a safe option to set.

Use **"ipsec-nat-traversal"** to enable and **"no ipsec-nat-traversal"** to disable NAT traversal.

Use **"show ipsec-nat-traversal"** to show whether IPsec NAT traversal is enabled or disabled.

Default values Disabled (**"no ipsec-nat-traversal"**)

37.3.3 Configure IP tunnel MTU

Syntax [no] ipsec-mtu-override <BYTES>

Context [Tunnel Configuration](#) context

Usage Override default MTU for *all* IPsec tunnels.

Use **"ipsec-mtu-override <BYTES>"** to specify a specific MTU value to use for all IPsec tunnels. Use **"no ipsec-mtu-override"** to return to the default setting.

Use **"show ipsec-mtu-override"** to show the configured IPsec MTU value.

Default values 1419 (bytes)

37.3.4 Managing IPsec VPN Tunnels

Syntax [no] ipsec <INDEX> where INDEX is a number greater or equal to 0.

Context [Tunnel Configuration](#) context

Usage Create, delete, or modify an IPsec VPN tunnel. Use **"ipsec <INDEX>"** to create a new IPsec tunnel, or to enter the IPsec Configuration context of an existing IPsec tunnel. (To find the index of configured tunnels, use **"show tunnel"** as described in [section 37.3.1](#).)

Use **"no ipsec <INDEX>"** to remove a specific IPsec VPN tunnel, or **"no ipsec"** to remove all configured IPsec VPN tunnels.

Use **"show ipsec <INDEX>"** to show all settings of a specific IPsec tunnel (also available as **"show"** command within the IPsec Configuration context).

Note

Tunnels which are not intended to be used should either be *deleted* or *disabled* (section 37.3.5).

At most 25 instances can be created.

Default values Not applicable.

37.3.5 Enable/disable an IPsec VPN tunnel

Syntax [no] enable

Context IPsec Configuration context

Usage Enable or disable an IPsec VPN tunnel. A disabled tunnel will be deactivated, but keeps its configuration settings.

Use **"enable"** to enable and **"no enable"** to disable an IPsec VPN tunnel.

Use **"show enable"** to show whether this IPsec tunnel is enabled or disabled.

Note

Tunnels which are not intended to be used should either be *deleted* (section 37.3.4) or *disabled*.

Default values Enabled

37.3.6 IKE phase-1 aggressive or main mode

Syntax [no] aggressive

Context IPsec Configuration context

Usage Select aggressive or main mode for the IKE phase-1 handshake.

Use **"aggressive"** to select aggressive mode, and **"no aggressive"** to select main mode.

Use **"show aggressive"** to show whether this IPsec tunnel is configured to use IKE *aggressive* or *main* mode. **"Enabled"** means *aggressive* mode, while **"Disabled"** means *main* mode.

Default values Disabled (**"no aggressive"**, i.e., *main* mode is use by default.)

37.3.7 Enable/disable Perfect Forward Secrecy

Syntax [no] pfs

Context IPsec Configuration context

Usage Enable or disable Perfect Forward Secrecy for this IPsec tunnel. Protects previous key exchanges even if the current one is compromised.

 **Note**

This setting is not supported by all IPsec implementations. It is however recommended to have it enabled, on both sides of the connection.

If you are unsure what to do, you can safely disable PFS. If the IPsec daemon receives a request with PFS, it will allow it despite how your having disabled it here, because there is absolutely no reason not to use PFS if it is available.

Use **"pfs"** to enable and **"no pfs"** to disable perfect forward secrecy.

Use **"show pfs"** to show whether *perfect forward secrecy* is enabled or disabled for this tunnel.

Default values Enabled ("pfs")

37.3.8 Configure allowed crypto algorithms for IKE phase-1

Syntax [no] ike crypto <3des|aes128|...> auth <md5|sha1|sha256>
dh <1024|...>

Context IPsec Configuration context

Usage Set IKE phase-1 handshake. Configure what security suite to use to protect the IKE authentication handshake. Here the security suite consists of three parameters:

- *Encryption algorithm*: Supported encryption algorithms are *3des*, *aes128*, *aes192* and *aes256*.
- *Message authentication/integrity*: Supported hash algorithms for message authentication are *md5*, *sha1* and *sha256*.
- *Diffie-Hellman groups*: Supported Diffie-Hellman groups are 1024 (DH group 2), 1536 (DH group 5), 2048 (DH group 14), 3072 (DH group 15), 4096 (DH group 16), 6144 (DH group 17) and 8192 (DH group 18).

By specifying an IKE suite, e.g., "**ike crypto aes256 auth sha1 dh 2048**" you will ensure that this suite is used to secure the IKE handshake - if the remote side does not support this suite, the handshake will fail.

Use "**no ike**" to specify the *automatic* security suite negotiation. When configured as an *initiator*, this means that all combinations will be tried (starting by offering a set of suites with either AES-128 or 3DES for encryption, SHA1, SHA256 or MD5 for authentication, and DH groups 1024, 1536 and 2048). When configured as a *responder* any combination of the listed algorithms will be accepted.

Use "**show ike**" to show the configured IKE Cipher suite for this tunnel, i.e., encryption algorithm, message authentication algorithm, and Diffie-Hellman group. "**Auto**" is shown if the VPN gateway is configured to auto-negotiate what IKE cipher suite to use.

Default values Auto ("**no ike**")

Note

If *aggressive* mode is selected for the IKE phase-1 handshake, the default security suite for IKE phase-1 negotiation is set to "AES128-SHA1-DH1024" ("**esp crypto aes128 auth sha1 dh 1024**").

Examples The following example show the output when AES-128 is used for encryption, SHA-1 for message authentication, and Diffie-Hellman group 1024.

Example

```
example:/config/tunnel/ipsec-0/#> show ike
AES128-SHA1-1024
example:/config/tunnel/ipsec-0/#>
```

37.3.9 Configure allowed crypto algorithms for ESP

Syntax [no] esp crypto <3des|aes128|...> auth <md5|sha1|sha256>
dh <auto|...>

Context IPsec Configuration context

Usage Set IKE Phase-2 hand shake negotiation. Configure what security suite ESP should use to protect the *data traffic* in the established VPN tunnel. Here the security suite consists of two parameters:

- *Encryption algorithm*: Supported encryption algorithms are *3des*, *aes128*, *aes192* and *aes256*.
- *Message authentication/integrity*: Supported hash algorithms for message authentication are *md5*, *sha1* and *sha256*.
- *Diffie-Hellman group for PFS*: The Diffie-Hellman group can be negotiated automatically, or a preferred group can be selected by hand. Supported Diffie-Hellman groups are 1024 (DH group 2), 1536 (DH group 5), 2048 (DH group 14), 3072 (DH group 15), 4096 (DH group 16), 6144 (DH group 17) and 8192 (DH group 18).

By specifying an ESP suite, e.g., **"esp crypto aes256 auth sha1 dh 1024"** you will ensure that this suite is used to secure the data traffic in the established IPsec ESP tunnel. IKE phase-1 handshake - if the remote side does not support this suite, the handshake will fail.

Use **"no esp"** to specify the *automatic* security suite negotiation. When configured as an *initiator*, this means that all combinations will be tried. When configured as a *responder* any combination of the listed algorithms will be accepted.

Use **"show esp"** to show the configured ESP Cipher suite for this tunnel. **"Auto"** is shown if the VPN gateway is configured to auto-negotiate what ESP cipher suite to use.

Default values Auto (**"no esp"**)

Note

If *aggressive* mode is selected for the IKE phase-1 handshake, the default security suite for IKE phase-2 negotiation is set to "AES128-SHA1-AUTO" (**"esp crypto aes128 auth sha1 dh auto"**).

37.3.10 Select Pre-shared Secret or Certificate based authentication

Syntax [no] method <psk|cert>

Context IPsec Configuration context

Usage Select Pre-shared secret or Certificate based IKE authentication. Use **"method psk"** to use pre-shared secret authentication (default), or **"method cert"** to use certificates for IKE authentication.

"no method" will return to default setting "method psk".

Use "show method" to show whether IKE authentication is configured to use PSK or certificate.

Default values Pre-shared Secret (method psk)

37.3.11 Configure IPsec Pre-shared Secret

Syntax [no] secret <PASSWORD>

Context IPsec Configuration context (Only valid when "method psk" is set.)

Usage Set pre-shared key (shared secret). The password string should consist of at least 8 characters and at most 63 characters.

Valid characters are ASCII characters 33-126, except '#' (ASCII 35).

Use "no secret" to remove a configured pre-shared secret.

Use "show secret" to show the configured pre-shared secret (PSK) for this tunnel.

Default values Empty

37.3.12 Select Local Certificate

Syntax [no] local-cert <LABEL>

Context IPsec Configuration context (Only valid when "method cert" is set.)

Usage Select local certificate (and associated private key), i.e., the certificate by which this unit will authenticate itself. The "LABEL" is the reference of the certificate when imported to the WeOS unit.

This setting is required when "method cert" is set.

Use "no local-cert" to remove the selection of local certificate.

Use "show local-cert" to show the local certificate setting.

Default values Disabled

37.3.13 Select Remote Certificate

Syntax [no] remote-cert <LABEL>

Context IPsec Configuration context (Only valid when "method cert" is set.)

Usage Select remote certificate, if the certificate of the trusted peer has been imported to this WeOS unit.

The "LABEL" is the reference of the certificate when imported to the WeOS unit.

Use "no remote-cert" to remove the selection of remote certificate.

Use "show remote-cert" to show the remote certificate setting.

Default values Disabled

37.3.14 Manage Remote CA restrictions

Syntax [no] remote-ca <same|any|dn <DNSTRING>>

Context IPsec Configuration context (Only valid when "method cert" and "no remote-cert" are set.)

Usage Define restrictions of the peer's CA. By default, the peer is required use a certificate issued by the same CA as this unit ("same").

Use "remote-ca any" to allow peers with a certificate issued by any of the CAs trusted by this unit. It is also possible to only accept peers with certificates issued by a specific CA (among the ones trusted by this unit) by the "remote-ca dn <DNSTRING>" setting.

"no remote-ca" will return to the default setting ("remote-ca same").

Use "show remote-ca" to show the remote CA setting.

Default values Same ("remote-ca same")

37.3.15 Specify IP Address/domain name of remote unit

Syntax [no] peer <IPADDR|FQDN>

Context IPsec Configuration context

Usage Set peer IP address, or DNS domain name. When acting as initiator, the peer setting defines the remote server to connect to. As responder it can be used to allow a single client or not.

Use "no peer" to allow connections from any client.

Use **"show peer"** to show the configured *peer IP address* or *peer domain name*. **"Any"** is shown if the peer can connect from any IP address.

Default values Any

37.3.16 Configure Outbound Interface

Syntax [no] outbound <IFACE>

Context IPsec Configuration context

Usage Set the outbound interface of this tunnel.

Use **"no outbound"** to automatically select the interface leading to the *default gateway* as outbound interface.

Use **"show outbound"** to show the configured *outbound interface* for this tunnel. **"Default Gateway"** is shown if the interface leading to the default gateway should be used as outbound interface.

See [section 37.1.1](#) for more information on the outbound interface.

Default values Auto (**"no outbound"**)

37.3.17 Configure Local Identifier

Syntax [no] local-id <inet <IPADDR|DOMAIN> | name <DOMAIN|USER> | email <USER@DOMAIN> | key <ID> | dn <DNSTRING>>

Context IPsec Configuration context

Usage Set the identifier (type and value) for the VPN gateway. The local-id is used by the VPN gateway during the IKE handshake. Typically the **"name"** type with a simple ID text string (e.g., **alice**) can be used to identify the VPN gateway.

For more details on available identification types and ID values, see [section 37.1.3](#).

If **"no local-id"** is selected for PSK authentication, the local-id will be of type **"inet"** (IPv4 address), using the IP address of the *Outbound interface* (see [section 37.3.16](#)) as identity. For certificate authentication, **"no local-id"** implies a local-id of type *Distinguished Name*, using the subject string of the local certificate as identity.

Use **"show local-id"** to show the configured *local identifier* for this tunnel, i.e., both the *local-id type* and the *local-id value*. **"Auto"** is shown if the local identifier is assigned as type **"inet"** with the IP address of the *outbound interface* as value.

Default values Auto (**"no local-id"**)

37.3.18 Configure Remote Identifier

Syntax [no] local-id <inet <IPADDR|DOMAIN> | name <DOMAIN|USER> | email <USER@DOMAIN> | key <ID> | dn <DNSTRING>>

Context IPsec Configuration context

Usage Set the identifier (type and value) for the peer VPN gateway. The remote-id is used by the peer VPN gateway during the IKE handshake. Typically the **"name"** type with a simple ID text string (e.g., **"bob"**) can be used to identify the peer VPN gateway.

For more details on available identification types and ID values, see [section 37.1.3](#).

If **"no remote-id"** is selected for PSK authentication, the **"remote-id"** will be of type **"inet"** (IPv4 address), using the IP address from the configured *Peer* (see [section 37.3.15](#)) as identity. A peer domain name will be resolved to an IP address.

For certificate authentication, **Auto** is discouraged for the **Peer ID**, see [section 37.1.8](#) for details.

Use **"show remote-id"** to show the configured *remote identifier* for this tunnel, i.e., both the *remote-id type* and the *remote-id value*. **"Auto"** is shown if the local identifier is assigned as type **"inet"** with the IP address of the *peer* as value.

Default values Auto (**"no remote-id"**)

37.3.19 Configure Local Subnet

Syntax [no] local-subnet <SUBNET/LEN | SUBNET NETMASK>

Context IPsec Configuration context

Usage Set the local subnet of this tunnel.

Only traffic from this IP range is allowed to enter the tunnel through this gateway, and traffic arriving through the tunnel is only accepted when destined to an address in this range.

If **"no local-subnet"** is specified, only traffic to/from the IP address of the *outbound interface* will be allowed through the tunnel.

Use **"show local-subnet"** to show the configured *local subnet* for this tunnel. **"None"** is shown if no local subnet has been configured.

Default values None (**"no local-subnet"**)

37.3.20 Configure Remote Subnet

Syntax [no] remote-subnet <SUBNET/LEN | SUBNET NETMASK> [shared]

Context IPsec Configuration context

Usage Set the remote subnet of this tunnel.

Only traffic from this IP range is allowed to enter the tunnel through this gateway, and traffic arriving through the tunnel is only accepted when destined to an address in this range.

In case the remote peer is a PC (see [fig. 37.3](#)), specify the PC's VPN client IP address with a **"/32"** prefix length, e.g., **"192.168.12.49/32"**.

If **"no remote-subnet"** is specified, only traffic to/from the IP address of the *Peer* will be allowed through the tunnel.

On a *responder*, you can specify that the remote subnet configured is *shared* by multiple initiators by setting the **"shared"** keyword (default disabled). The local subnet of each initiator must be within the range specified by the responder's remote subnet. Without the **"shared"** keyword, there can only be one initiator for this tunnel configuration, and its local subnet must match the responder's remote subnet.

Use **"show remote-subnet"** to show the configured *remote subnet* for this tunnel. **"None"** is shown if no remote subnet has been configured.

Default values None (**"no remote-subnet"**)

37.3.21 Configure Local IP Protocol and UDP/TCP port

Syntax [no] local-protocol <PROTOCOL> [port <PORT>]

Context IPsec Configuration context

Usage Allowed transmitted IP protocol, and (TCP/UDP) port over this connection. This setting must match in both ends of the tunnel for the tunnel to start. **"PROTOCOL"** is IP protocol specified as a number (0-255), or by name. If protocol is TCP(6) or UDP(17), the traffic can further match specific (TCP/UDP) port number for transmitted packets (**"port <PORT>"**).

If **"no local-protocol"** is specified, all IP protocols are allow.

Use **"show local-protocol"** to show the local IP protocol and UDP/TCP port settings for this tunnel.

Default values Disabled (**"no local-protocol"**), i.e., all local IP protocols allowed.

37.3.22 Configure Remote IP Protocol and UDP/TCP port

Syntax [no] remote-protocol <PROTOCOL> [port <PORT>]

Context IPsec Configuration context

Usage Allowed received IP protocol, and (TCP/UDP) port over this connection. This setting must match in both ends of the tunnel for the tunnel to start. **"PROTOCOL"** is IP protocol specified as a number (0-255) or by name. If protocol is TCP(6) or UDP(17), the traffic can further match specific (TCP/UDP) port number for received packets (**"port <PORT>"**).

If **"no remote-protocol"** is specified, all IP protocols are allow.

Use **"show remote-protocol"** to show the remote IP protocol and UDP/TCP port settings for this tunnel.

Default values Disabled (**"no remote-protocol"**), i.e., all local IP protocols allowed.

37.3.23 Configure Initiator/Responder Setting

Syntax [no] initiator

Context IPsec Configuration context

Usage Select whether the VPN gateway should act as initiator or responder of this IPsec tunnel.

Use **"initiator"** to make the VPN gateway act as *initiator*, and **"no initiator"** to make it act as responder.

Use **"show initiator"** to show whether the VPN gateway acts as *Initiator* or *Responder* for this tunnel.

Default values Responder (**"no initiator"**)

37.3.24 Configure Dead Peer Detection Action

Syntax [no] `dpd-action <clear|hold|restart>`

Context [IPsec Configuration](#) context

Usage Set the DPD action for this VPN gateway. The DPD action defines how the VPN gateway should react when the peer is determined to be unreachable (i.e., "dead").

Use **"no dpd-action"** to disable the DPD mechanism on this VPN gateway. When disabled, this VPN gateway will not probe the peer to check if it is down, however, this VPN gateway will still respond to DPD probing messages from the peer. That is, it is possible for the peer to the DPD mechanism successfully even though DPD is disabled on this side.

Use **"show dpd-action"** to show the configured DPD action setting. **"off"** is shown if DPD has been disabled on this VPN gateway.

For more information on DPD action settings, see [section 37.1.6](#).

Default values This depends on the role of this VPN gateway.

- *Initiator*: If this VPN gateway is the initiator of the tunnel, the DPD action is by default set to *restart* (**"dpd-action restart"**)
- *Responder*: If this VPN gateway is the responder of the tunnel, the DPD action is by default set to *clear* (**"dpd-action clear"**)

37.3.25 Configure Dead Peer Detection Delay

Syntax [no] `dpd-delay <SECONDS>`

Context [IPsec Configuration](#) context

Usage Set the DPD probing interval. The DPD delay is the interval between DPD probing messages sent by this VPN gateway. (The DPD delay setting on the two peers are independent, thus they may differ.)

Use **"no dpd-delay"** to return to the default setting.

Use **"show dpd-delay"** to show the configured DPD delay setting (in seconds).

Default values 30 (seconds)

37.3.26 Configure Dead Peer Detection Timeout

Syntax [no] dpd-timeout <SECONDS>

Context IPsec Configuration context

Usage Set the DPD timeout. If a period corresponding to the DPD timeout elapses without getting any response on the DPD probe messages, the VPN gateway considers the peer to be down.

Use **"no dpd-timeout"** to return to the default setting.

Use **"show dpd-timeout"** to show the configured DPD timeout setting (in seconds).

Default values 120 (seconds)

37.3.27 Configure IKE Lifetime

Syntax [no] ike-lifetime <SECONDS[s] | MINUTESm | HOURSh | DAYSD>

Context IPsec Configuration context

Usage Set the IKE (phase 1) security association lifetime. When this time has passed, a new phase 1 negotiation will be initiated. The remote peer may use a different value. In that case, the peer with the lowest timeout will initiate the renegotiation first.

Use **"no ike-lifetime"** to return to the default setting.

Use **"show ike-lifetime"** to show the configured IKE (phase 1) security association lifetime setting (in seconds).

Default values 3600 seconds (1h)

37.3.28 Configure SA (ESP) Lifetime

Syntax [no] sa-lifetime <SECONDS[s] | MINUTESm | HOURSh | DAYSD>

Context [IPsec Configuration](#) context

Usage Set the ESP (phase 2) security association lifetime. When this time has passed, a new phase 2 negotiation will be initiated. The remote peer may use a different value. In that case, the peer with the lowest timeout will initiate the renegotiation first.

Use **"no sa-lifetime"** to return to the default setting.

Use **"show sa-lifetime"** to show the configured ESP (phase 2) security association lifetime setting (in seconds).

Default values 28800 seconds (8h)

37.3.29 Show IPsec Tunnel Status

Syntax show tunnel ipsec [ID]

Context [Admin Exec](#) context.

Usage Show the status for all or for a specific IPsec tunnel.

Default values If no tunnel ID is specified, the status of all tunnels is shown.

37.4 Feature Parameters

MAX_IPSEC_INSTANCES 25

Chapter 38

SSL VPN

This chapter describes the WeOS SSL VPN support. The WeOS SSL VPN is based on OpenVPN¹, and WeOS units can act both as SSL VPN server and client. The two primary uses of WeOS SSL VPN are:

- *Remote access VPN*: In remote access VPNs (or *Host-to-Net* VPNs), one WeOS unit is configured as SSL VPN *server* Gateway, to which one or more SSL VPN *clients* can connect. These clients are individual hosts, connecting to the server (typically) to get access to a network on the server.
- *Site-to-site VPN*: In site-to-site VPNs (or *Net-to-Net* VPNs), both the SSL VPN server and client are gateways, used to establish secure connectivity between networks on the client and server side.

38.1 Overview of SSL VPN Management Features

Table 38.1 summarises the SSL VPN features available in WeOS. These features are further explored in the following sections.

38.1.1 Introduction to SSL VPN

In an SSL VPN we have a VPN Server Gateway (Alice) providing secure access to a protected network (e.g., a central office network) to one or more VPN Clients connecting over an insecure network such as the Internet. The client could be a single host (a remote access SSL VPN), or the client could itself be a VPN gateway

¹OpenVPN home page, <https://openvpn.net> (March 2019).

Feature	Web	CLI	General Description
<u>General SSL VPN Settings</u>			
Role (Server/Client)	X	X	Section 38.1.3.1
SSL Instances	X	X	Section 38.1.3.2
Max nb of clients	X	X	Section 38.1.3.3
Transport settings (UDP/TCP)	X	X	Section 38.1.3.4
Type (Layer2/Layer3)	X	X	Section 38.1.3.5
Keep-alive	X	X	Section 38.1.3.6
Compression	X	X	Section 38.1.3.7
<u>Tunnel Network Settings</u>			
IP address assignment	X	X	Section 38.1.4.1
Address pool	X	X	-"
Address per CN	X	X	-"
IP route assignment	X	X	Section 38.1.4.2
Pushed networks	X	X	-"
Static routing	X	X	-"
Dynamic routing	X	X	-"
Traffic between clients	X	X	-"
<u>Tunnel Security Settings</u>			
Authentication	X	X	Section 38.1.5.1
Certificates	X	X	-"
Duplicate CN	X	X	-"
Username/password	X	X	-"
Local-DB (Server)	X	X	-"
Auth. Backend (Server)	X	X	-"
Cipher settings	X	X	Section 38.1.5.2
TLS authentication settings	X	X	Section 38.1.5.3

Table 38.1: Summary of SSL VPN features

with a local network attached (a site-to-site SSL VPN), see clients Bob and Charlie respectively in in [fig. 38.1](#).

We refer to Alice as a VPN Server, as she waits for VPN Clients to establish VPN connections. Bob (and Charlie) is the VPN client initiating the connection establishment.

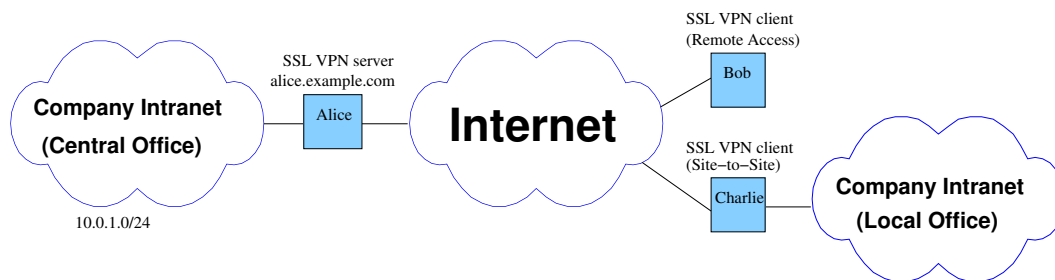

Figure 38.1: SSL VPN (OpenVPN) can be used for remote access for individual hosts (Bob connecting to Alice), or for site-to-site VPNs connecting networks at different sites (Charlie connecting to Alice).

The VPN server (Alice) may be reachable via a fixed IP address on her upstream interface. But if Alice acquires her IP address dynamically from her ISP, it is recommended that Alice uses Dynamic DNS (DDNS) to bind her IP address to a domain name, see [section 22.3.3](#). The VPN client (Bob) would then use Alice' domain name when initiating the SSL tunnel (*alice.example.com* in [figs. 38.1](#)).

The outline of the remainder of this section are as follows:

- *Starting out examples:* [Section 38.1.2](#) covers the the essential steps to get your tunnel up and running for remote access and site-to-site VPNs. It is recommended to start with this section, as it provides an overview of what is needed. Later sections will give detailed information on specific settings.
- *General tunnel settings:* [Section 38.1.3](#) describes how to create multiple SSL instances, if the instance should be in client or server mode, provide a layer-2 or layer-3 service, etc.
- *Tunnel IP address and routing settings:* [Section 38.1.4](#) presents the OpenVPN features to assign IP addresses and routes for the SSL network interfaces, complementing the regular WeOS IP and route configuration.
- *Tunnel security settings:* [Section 38.1.5](#) covers authentication, encryption and integrity protection mechanisms and settings for SSL VPNs.
- *Other relevant settings:* [Section 38.1.6](#) gives some hints on other settings typically used on SSL/OpenVPN units, such as NAT/NAPT, firewall, and NTP client settings.

38.1.2 Starting out - remote access and site-to-site VPNs

In the following sections the basic steps to setup a remote access VPN (section 38.1.2.1) or site-to-site VPN (section 38.1.2.2) on your WeOS units will be shown.

The focus is on the here is on the configuration of the SSL/OpenVPN tunnel, although IP assignment and routing will be touched upon. These *starting out* sections provides a means to get you started. More information on how you can fine tune your SSL and routing settings, as well as hints on setting up related services such as firewall and NAT, will be covered in later sections.

The SSL/OpenVPN support in WeOS utilises certificates to authenticate the VPN client and server. In the configuration examples in the starting out sections, is assumed that *appropriate certificates has already been created and imported*.

38.1.2.1 Starting out with remote access VPN

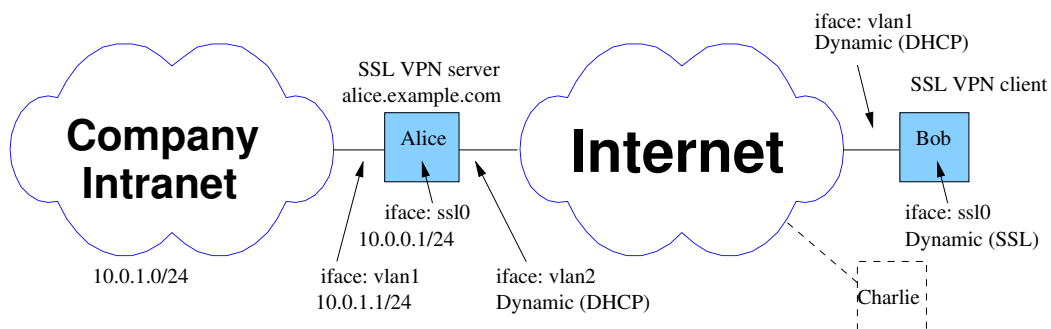

Figure 38.2: SSL remote access setup. One or more SSL Clients ("road-warriors" Bob and Charlie) can access the company private network via the SSL Server Gateway (Alice).

Assume you wish to setup a remote access VPN as shown in fig. 38.2. The simplest way to achieve this in WeOS is to use *layer-3* SSL tunnels. The server (Alice) will have a static IP address (here 10.0.0.1/24) on her SSL interface, while the clients (Bob and Charlie) get their SSL IP addresses from a pool administrated by Alice.

Below is an example of the essential steps to setup Alice as server gateway in fig. 38.2. An SSL server instance is created, specifying certificate, CA certificate and TLS authentication key to use, a pool for address assignment, and a route to be pushed to the clients during connection establishment. Alice own SSL address

is configured statically. Finally, firewall rules to allow traffic to flow between Alice' SSL interface and her local interface is added (it is assumed that the firewall is already enabled, e.g., as Alice typically assumed to act as firewall and NAT gateway).

Example

```
alice:/#> configure
alice:/config/#> tunnel
alice:/config/tunnel/#> ssl 0
alice:/config/tunnel/ssl-0/#> certificate alice
alice:/config/tunnel/ssl-0/#> ca-certificate alice
alice:/config/tunnel/ssl-0/#> tls-auth label ta-key direction 0
alice:/config/tunnel/ssl-0/#> pool start 10.0.0.100 end 10.0.0.119
alice:/config/tunnel/ssl-0/#> push-network 10.0.1.0/24
alice:/config/tunnel/ssl-0/#> end
alice:/config/tunnel/#> end
alice:/config/#> iface ssl0
alice:/config/iface-ssl0/#> inet static
alice:/config/iface-ssl0/#> address 10.0.0.1/24
alice:/config/iface-ssl0/#> end
alice:/config/#> ip
alice:/config/ip/#> firewall
alice:/config/ip/firewall/#> filter allow in vlan1 out ssl0
alice:/config/ip/firewall/#> filter allow in ssl0 out vlan1
alice:/config/ip/firewall/#> leave
alice:/#>
```

On the client Bob wishing to use the remote access service, the corresponding SSL VPN configuration can look as follows. A client SSL configuration is created, specifying certificate, CA certificate and TLS-authentication key to use, and also the address or domain name of the server to connect to.

Example

```
bob:/#> configure
bob:/config/#> tunnel
bob:/config/tunnel/#> ssl 0
bob:/config/tunnel/ssl-0/#> no server
bob:/config/tunnel/ssl-0/#> certificate bob
bob:/config/tunnel/ssl-0/#> ca-certificate bob
bob:/config/tunnel/ssl-0/#> tls-auth label ta-key direction 1
bob:/config/tunnel/ssl-0/#> peer alice.example.com
bob:/config/tunnel/ssl-0/#> leave
bob:/#>
```

Upon successful VPN connection establishment, Bob would get an SSL IP address from the address pool administrated by Alice. (Acquiring an address dynamically is the default for SSL interfaces.)

Example

```
bob:/#> show iface
Interface Name  Oper  Address/Length  MTU  MAC/PtP Address
-----
lo              UP    127.0.0.1/8     16436 N/A
ssl0           UP    10.0.0.100/24   1500  N/A
vlan1          UP    192.168.2.101/24 1500  00:07:7c:82:2b:c7
-----
bob:/#>
```

Bob would also get the route towards the central office network (10.0.1.0/24) pushed dynamically as part of the tunnel establishment. As Alice has setup corresponding firewall filter rules, he will be able to communicate with nodes on the central office network.

Example

```
bob:/#> sh ip route
S - Static | C - Connected | K - Kernel route | > - Selected route
O - OSPF   | R - RIP         | [Distance/Metric] | * - Active route

S>* 0.0.0.0/0 [1/0] via 192.168.2.1, vlan1
C>* 10.0.0.0/24 is directly connected, ssl0
S>* 10.0.1.0/24 [16/0] via 10.0.0.1, ssl0
C>* 127.0.0.0/8 is directly connected, lo
C>* 192.168.2.0/24 is directly connected, vlan1
bob:/#>
```

Another client (Charlie) could make the corresponding client SSL configuration, and also be assigned an address from the pool.

Example

```
charlie:/#> show iface
Interface Name  Oper  Address/Length  MTU  MAC/PtP Address
-----
lo              UP    127.0.0.1/8     16436 N/A
ssl0           UP    10.0.0.101/24   1500  N/A
vlan1          UP    192.168.3.143/24 1500  00:07:7c:83:d0:65
-----
charlie:/#>
```

Charlie would also be able to communicate with nodes within the central office network (10.0.1.0/24), just like Bob can.

Now assume you wish to allow communication between clients Bob and Charlie through the SSL tunnel, as shown in [fig. 38.3](#). *Client to client* communication is

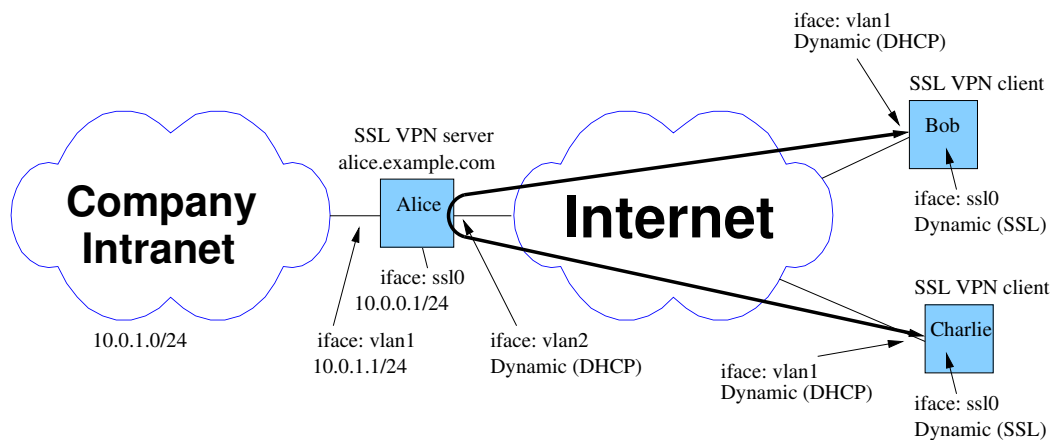

Figure 38.3: Client-to-client communication in SSL remote access setup.

prohibited by default, thus additional settings are needed at the server (Alice) if you wish to allow Bob and Charlie to communicate with each other. For remote access networks there are two options to enable client to client communication, as described below.

The first approach is to let the SSL (OpenVPN) function at Alice forward traffic between clients *internally*, i.e., without involving her firewall. This is done using the *client-to-client* setting within her SSL configuration.

Example

```
alice:/#> configure
alice:/config/#> tunnel
alice:/config/tunnel/#> ssl 0
alice:/config/tunnel/ssl-0/#> client-to-client
alice:/config/tunnel/ssl-0/#> leave
alice:/#>
```

The second alternative is to add appropriate *allow* rules to Alice firewall. A simple example is given below, allowing all clients within the SSL network to communicate with each other.

Example

```
alice:/#> configure
alice:/config/#> ip
alice:/config/ip/#> firewall
alice:/config/ip/firewall/#> filter allow in ssl0 out ssl0
alice:/config/ip/firewall/#> leave
```

```
alice:/#>
```

38.1.2.2 Starting out with site-to-site VPN

Fig. 38.4 shows an example where an SSL VPN is established to securely connect two sites, a branch office (client gateway Bob) and a central office (server gateway Alice).

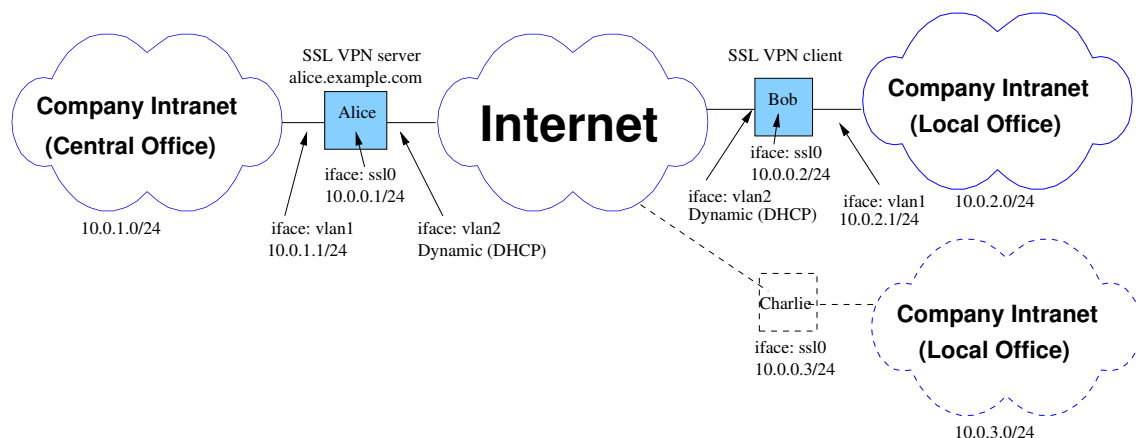

Figure 38.4: SSL site-to-site setup. One or more SSL Client Gateways (Bob and Charlie) can establish an SSL tunnel to the SSL Server Gateway, and provide a site-to-site VPN solution between the central office and branch office networks.

In WeOS, site-to-site VPNs with SSL can be established using *layer2* SSL interfaces. Below is an example of the essential steps to setup Alice as server gateway in fig. 38.4. Here static IP assignment is used for the SSL network (no address "pool" at the server) and static routing is used both on server and client gateways to route traffic through the tunnel. We will look at alternatives later. The example also prepares for an additional client gateway (Charlie) with subnet 10.0.3.0/24.

Example

```
alice:/#> configure
alice:/config/#> tunnel
alice:/config/tunnel/#> ssl 0
alice:/config/tunnel/ssl-0/#> type layer2
alice:/config/tunnel/ssl-0/#> certificate alice
alice:/config/tunnel/ssl-0/#> ca-certificate alice
alice:/config/tunnel/ssl-0/#> tls-auth label ta-key direction 0
alice:/config/tunnel/ssl-0/#> push-network 10.0.1.0/24
alice:/config/tunnel/ssl-0/#> end
```

```
alice:/config/tunnel/#> end
alice:/config/#> iface ssl0
alice:/config/iface-ssl0/#> inet static
alice:/config/iface-ssl0/#> address 10.0.0.1/24
alice:/config/iface-ssl0/#> end
alice:/config/#> ip
alice:/config/ip/#> route 10.0.2.0/24 10.0.0.2
alice:/config/ip/#> route 10.0.3.0/24 10.0.0.3
alice:/config/ip/#> firewall
alice:/config/ip/firewall/#> filter allow in vlan1 out ssl0
alice:/config/ip/firewall/#> filter allow in ssl0 out vlan1
alice:/config/ip/firewall/#> leave
alice:/#>
```

On the client gateway Bob wishing to use the site-to-site service, the corresponding SSL VPN configuration can look as follows.

Example

```
bob:/#> configure
bob:/config/#> tunnel
bob:/config/tunnel/#> ssl 0
bob:/config/tunnel/ssl-0/#> no server
bob:/config/tunnel/ssl-0/#> type layer2
bob:/config/tunnel/ssl-0/#> certificate bob
bob:/config/tunnel/ssl-0/#> ca-certificate bob
bob:/config/tunnel/ssl-0/#> tls-auth label ta-key direction 1
bob:/config/tunnel/ssl-0/#> peer alice.example.com
bob:/config/tunnel/ssl-0/#> end
bob:/config/tunnel/#> end
bob:/config/#> iface ssl0
bob:/config/iface-ssl0/#> inet static
bob:/config/iface-ssl0/#> address 10.0.0.2/24
bob:/config/iface-ssl0/#> end
bob:/config/#> ip
bob:/config/ip/#> firewall
bob:/config/ip/firewall/#> filter allow in ssl0 out vlan1
bob:/config/ip/firewall/#> filter allow in vlan1 out ssl0
bob:/config/ip/firewall/#> leave
bob:/#>
```

Once the tunnel comes up, the IP settings on Bob may look as follows.

Example

```
bob:/#> show iface
```

Interface Name	Oper	Address/Length	MTU	MAC/PtP Address
lo	UP	127.0.0.1/8	16436	N/A
ssl0	UP	10.0.0.2/24	1500	d6:87:0f:af:a5:87
vlan1	UP	10.0.2.1/24	1500	00:07:7c:82:2b:c8
vlan2	UP	192.168.2.101/24	1500	00:07:7c:82:2b:c7

```
bob:/#>
```

The routing table at Bob may look as shown below. If the SSL tunnel is up, units on Bob's local network (10.0.2.0/24) will be able to communicate securely with units in the central office (10.0.1.0/24).

Example

```
bob:/#> show ip route
S - Static | C - Connected | K - Kernel route | > - Selected route
O - OSPF | R - RIP | [Distance/Metric] | * - Active route

S>* 0.0.0.0/0 [1/0] via 192.168.2.1, vlan2
C>* 10.0.0.0/24 is directly connected, ssl0
S>* 10.0.1.0/24 [16/0] via 10.0.0.1, ssl0
C>* 10.0.2.0/24 is directly connected, vlan1
C>* 127.0.0.0/8 is directly connected, lo
C>* 192.168.2.0/24 is directly connected, vlan2
bob:/#>
```

A second client gateway, Charlie, can be configured in the corresponding way as Bob, be it with different local subnet (10.0.3.0/24) as shown in [fig. 38.4](#). When Charlie's tunnel to Alice is up, his routing table may look follows.

Example

```
charlie:/#> show iface
Interface Name Oper Address/Length MTU MAC/PtP Address
-----
lo UP 127.0.0.1/8 16436 N/A
ssl0 UP 10.0.0.3/24 1500 12:88:5a:39:08:8d
vlan1 UP 10.0.3.1/24 1500 00:07:7c:83:d0:66
vlan2 UP 192.168.3.143/24 1500 00:07:7c:83:d0:65
-----
charlie:/#>
```

By default, units on Bob's and Charlie's local network can communicate with units on the central office, but they cannot communicate with each other. If you wish to allow for *client to client* communication in the site-to-site VPN, then you should use the enable the *client-to-client* setting as the server Alice.

Example

```
alice:/#> configure
alice:/config/#> tunnel
alice:/config/tunnel/#> ssl 0
alice:/config/tunnel/ssl-0/#> client-to-client
alice:/config/tunnel/ssl-0/#> leave
```

```
alice:/#>
```

Furthermore, Bob and Charlie must know how to route traffic for their respective subnet. Below the necessary routing setting on Bob is shown.

Example

```
bob:/#> configure
bob:/config/#> ip
bob:/config/ip/#> route 10.0.3.0/24 10.0.0.3
bob:/config/ip/#> leave
bob:/#>
```

And this is the corresponding routing setting on Charlie.

Example

```
charlie:/#> configure
charlie:/config/#> ip
charlie:/config/ip/#> route 10.0.2.0/24 10.0.0.2
charlie:/config/ip/#> leave
charlie:/#>
```

38.1.3 SSL instances and general setting

You can configure up to MAX_SSL_INSTANCES (3) SSL/OpenVPN instances in your unit, and each instance can be configured independently as *server* or *client*.

38.1.3.1 Setting up unit as client or server

By default, a WeOS SSL instance is configured as server. You configure an instance to client by using the **"no server"** setting.

Example

```
bob:/#> configure
bob:/config/#> tunnel
bob:/config/tunnel/#> ssl 0
bob:/config/tunnel/ssl-0/#> no server
bob:/config/tunnel/ssl-0/#>
```

The *server* is the SSL entity waiting for client(s) to connect. Most SSL settings are common to both clients and servers, but there are also settings which are unique. For example, a client needs to know the IP address or domain name of the server to connect to. A server can for example be configured with an address pool to dynamically assign addresses to connecting clients.

38.1.3.2 Using one or multiple SSL instances

Typically, you only need a single instance, as multiple clients can connect simultaneously to a single server instance; this was the case in the starting out examples in [sections 38.1.2.1](#) and [38.1.2.2](#).

Still, there may be cases where you wish to run multiple SSL instances, e.g., the server (Alice) may wish to have one SSL instance for with a *layer-3* interface, suitable for remote access VPN, and another instance with a *layer-2* interface for site-to-site VPN.

When creating multiple SSL instances, ensure that they use different *port numbers*. The example below creates a second SSL instance on the server (Alice), listening on UDP port 1195 (default is 1194).

Example

```
alice:/#> configure
alice:/config/#> tunnel
alice:/config/tunnel/#> ssl 1
alice:/config/tunnel/ssl-1/#> port 1195
alice:/config/tunnel/ssl-1/#>
```

38.1.3.3 Number of clients per instance

By default up to 25 clients are allowed to connect simultaneously to each server instance. This limit can be changed, or even removed, using the **"max-clients"** setting. The exact number of connections the server can handle can be further limited for performance reasons, as it depends on the platform of your product ([section 1.5](#)), the traffic load of the established tunnels as well as the configuration of your unit.

Example

```
alice:/#> configure
alice:/config/#> tunnel
alice:/config/tunnel/#> ssl 0
```

```
alice:/config/tunnel/ssl-0/#> no max-clients
alice:/config/tunnel/ssl-0/#>
```

38.1.3.4 Tunnel Transport Settings

The WeOS SSL support assumes that there is an SSL Server unit and an SSL Client unit, where the client (Bob) initiates the VPN connection to the server (Alice). The SSL tunnel can be carried over UDP or TCP. By default UDP transport is used, with UDP port number 1194.

In case Bob is located behind a firewall blocking outgoing traffic for UDP port 1194, an alternative can be to configure Alice and Bob to use TCP transport with TCP port 443. This port is typically used for HTTPS traffic, and most firewalls will therefore allow such traffic to pass.

Note
As of WeOS v4.33.0, if you configure the your SSL server (Alice) to listen to TCP port 443, you should either disable Alice' web server or configure her web server to listen for HTTPS at another port.

An example where Alice listens for SSL connections on TCP port 443 is given below.

Example

```
alice:/config/#> web
alice:/config/web/#> ssl-port 8443
alice:/config/web/#> end
alice:/config/#> tunnel
alice:/config/tunnel/#> ssl 0
alice:/config/tunnel/ssl-0/#> protocol tcp
alice:/config/tunnel/ssl-0/#> port 443
alice:/config/tunnel/ssl-0/#> leave
alice:/#>
```

38.1.3.5 Selecting layer-2 or layer-3 VPN interfaces

The SSL network interface can either be a *layer-3* interface or a *layer-2* interface.

- *Layer-3 interface (IP)*: By default, WeOS SSL tunnels have layer-3 interfaces. This simplifies setting up a *remote access* solution (see [fig. 38.2](#)) with the WeOS unit as SSL VPN Server Gateway, since many SSL VPN clients use layer-3 interfaces by default.

- *Layer-2 interface (LAN)*: Layer-2 SSL interfaces have MAC addresses, just like other LAN interfaces in WeOS. As of WeOS v4.33.0 layer-2 is the mandatory interface type when using SSL in *site-to-site* setups (see [fig. 38.4](#)). Dynamic routing protocols such as OSPF ([chapter 29](#)) and RIP ([chapter 30](#)) can be used on layer-2 SSL interfaces.

Note

As of WeOS v4.33.0, the layer-2 SSL interfaces can **not** be added to VLANs, i.e., it is not possible to bridge traffic between the SSL tunnel and the Ethernet or DSL ports on your WeOS unit.

There are also differences between layer-2 and layer-3 SSL interfaces when managing client-client communication, see [section 38.1.4.2.4](#).

Below is an example of configuring the SSL interface type to layer-2 at Alice.

Example

```
alice:/config/#> tunnel
alice:/config/tunnel/#> ssl 0
alice:/config/tunnel/ssl-0/#> type layer2
alice:/config/tunnel/ssl-0/#> leave
alice:/#>
```

38.1.3.6 Tunnel keepalive and dead peer detection

The "**keepalive**" setting is used (1) to keep session state in intermediate firewalls and NAT gateways ("ping" messages are sent at a configurable interval when no data is transmitted), and (2) to restart the tunnel if the connection has gone down or if the server domain name resolves to a new IP address.

Thus the *keepalive* setting also resembles a dead-peer-detection mechanism. Default is to send "pings" at a 10 second interval, and to restart the tunnel (including DNS lookup) after 60 seconds² if no response is received. The setting at the VPN server is pushed to the connecting VPN clients, unless the client declines this using the "**no pull**" setting.

In the example below, the keepalive interval and restart timeout are lowered to 4 seconds and 13 seconds respectively.

²On the server side, the timeout interval is twice the configured value, i.e., a configured timeout of 60 seconds results in an effective timeout of 120 seconds. The purpose is to ensure that a timeout is detected on a client before the server side drops the connection.

 **Example**

```
alice:/#> configure
alice:/config/#> tunnel
alice:/config/tunnel/#> ssl 0
alice:/config/tunnel/ssl-0/#> keepalive interval 4 restart 13
alice:/config/tunnel/ssl-0/#>
```

38.1.3.7 Data compression

WeOS supports LZO compression for the SSL tunnel. When LZO compression is enabled, you can select to always compress or you set the **"adaptive"** mode when compression is dynamically turned on and off by measuring its *usefulness* (if the data transmitted is determined to already be sufficiently compressed, additional LZO compression is disabled). Default setting is **"compression adaptive"**, i.e., compression is enabled in adaptive mode.

 **Note**

As of WeOS v4.33.0, the compression setting at the VPN client and VPN server must match.

38.1.4 IP address and Routing Settings

For the SSL tunnel, Alice and Bob will have an SSL network interface (with names such as *ssl0*), which can be assigned an IP address, and be used as other network interfaces when it comes to routing and firewall settings, etc. The SSL interface can either be a layer-2 or layer-3 interface, see [section 38.1.3.5](#) for more information.

Multiple clients (Bob and Charlie) can connect to the same server (instance). The clients and the server forms a virtual *subnet topology*³.

- IP assignment: Alice, Bob, and Charlie will each have an IP address within this virtual subnet. See [section 38.1.4.1](#) for information on how to assign IP addresses at the server and client side. That section also touches upon related settings, such as *domain name server* and IP routes.

³Although other topologies are possible for layer-3 SSL interfaces, current WeOS support is limited to the *subnet topology*. For more information on other possible SSL topologies not yet supported by WeOS (*p2p* and *net30*), see <https://openvpn.net> (March 2019).

- **Client to client communication:** It is possible for two SSL clients to communicate with each other. This is disabled by default, see [section 38.1.4.2.4](#) for more information.

38.1.4.1 IP address assignment and SSL VPNs

In WeOS, the SSL VPN server (Alice) will always have a statically assigned address, while the SSL client (Bob) can either be assigned his SSL address statically or acquire it dynamically as part of the SSL tunnel establishment. Similar to other network interfaces, it is also possible to assign secondary IP addresses ([section 22.2.5](#)) to SSL interfaces.

- **Static IP addresses:** By default SSL interfaces are configured for dynamic IP address assignment. This often works well on SSL clients, but on the SSL server side, static IP assignment is used. An example for Alice in [fig. 38.2](#) is shown below.

Example

```
alice:/config/#> iface ssl0
alice:/config/iface-ssl0/#> inet static
alice:/config/iface-ssl0/#> address 10.0.0.1/24
alice:/config/iface-ssl0/#> leave
alice:/#>
```

It possible to configure clients (Bob, Charlie, etc.) with static addresses too on the SSL interface, even though it requires individual configuration on every client. An example is for client Bob is given below, assuming he uses static IP address for interface `ssl0` as in [fig. 38.4](#).

Example

```
bob:/config/#> iface ssl0
bob:/config/iface-ssl0/#> inet static
bob:/config/iface-ssl0/#> address 10.0.0.2/24
bob:/config/iface-ssl0/#> leave
bob:/#>
```

- **Dynamic IP addresses:** Alice could hand out addresses dynamically to the SSL interface on Bob, Charlie and other SSL clients. This makes IP configuration on the clients simple. Bob configures his SSL interface for dynamic address assignment as shown below:

 **Example**

```
bob:/config/#> iface ssl0
bob:/config/iface-ssl0/#> inet dynamic
bob:/config/iface-ssl0/#> leave
bob:/#>
```

Alice can either hand out addresses from a pool or by defining client specific addresses. Using a pool is somewhat simpler, but specific address assignment can be useful in some cases. Both alternatives are described further below:

- *Address pool*: Alice can define an address pool to assign addresses from, see below:

 **Example**

```
alice:/config/#> tunnel
alice:/config/tunnel/#> ssl 0
alice:/config/tunnel/ssl-0/#> pool start 10.0.0.100 end 10.0.0.119
alice:/config/tunnel/ssl-0/#> leave
alice:/#>
```

An optional "netmask" parameter can be added to the "**pool**" command, if the netmask for the clients should be smaller than the netmask of Alice' SSL interface (set to **"/24"** in the example above).

- *Client specific address setting*: Alice could define what address a specific client should get, matching on the *X.509 common name* found in the client's certificate. Up to MAX_SSL_CN_BIND_INST (100) CN bindings can be configured per SSL instance.

The example below shows how to let Alice provide address *10.0.0.2/24* to a client with common name *bob* in its certificate.

 **Example**

```
alice:/config/#> tunnel
alice:/config/tunnel/#> ssl 0
alice:/config/tunnel/ssl-0/#> cn-binding 1
alice:/config/tunnel/ssl-0/cn-binding-1/#> common-name bob
alice:/config/tunnel/ssl-0/cn-binding-1/#> address 10.0.0.2/24
alice:/config/tunnel/ssl-0/cn-binding-1/#> leave
alice:/#>
```

38.1.4.2 IP routes and SSL VPNs

There are several ways to handling IP routing when using SSL tunnels, both utilising regular routing mechanisms in WeOS (static routes and dynamic routing protocols such as RIP and OSPF), but also specific mechanisms provided by the SSL/OpenVPN service.

What method to use depends on the use case and your preferences. For instance, in the *starting out* examples, SSL/OpenVPN services to push routes to clients was used for the *remote access* example ([section 38.1.2.1](#)), while a combination of SSL/OpenVPN services (push network) and regular WeOS static routing were used for the *site-to-site* example ([section 38.1.2.2](#)). These and other mechanisms will be covered in the following subsections.

38.1.4.2.1 Server pushing network routes The SSL server (Alice) can push network routes to the client (Bob). Bob will then automatically add these routes (with Alice as *next-hop*) upon tunnel establishment. Up to MAX_SSL_PUSH_SUBNETS (10) subnets can be pushed.

The example below show how Alice can push the route to her local network ([figs. 38.2](#) and [38.4](#)) to connecting clients.

Example

```
alice:/#> configure
alice:/config/#> tunnel
alice:/config/tunnel/#> ssl 0
alice:/config/tunnel/ssl-0/#> push-network 10.0.1.0/24
alice:/config/tunnel/ssl-0/#>
```

Bob can decline using these settings offered by Alice, by using the **"no pull"** command. This does not affect Bob's IP address assignment, which is instead controlled via interface settings as described in [section 38.1.4.1](#).

Note

It is *not* possible to push routes from client to server. That is why additional routing methods are needed in site-to-site setups. In the example in [section 38.1.2.2](#), this was handled by adding static routes.

38.1.4.2.2 Static routing



Note

In WeOS, using static routing with SSL VPNs, can only be used with layer-2 VPN tunnels ([section 38.1.3.5](#)).

In site-to-site setups ([fig. 38.4](#)), the **"push-network"** primitive can be used to enable clients (Bob and Charlie) to dynamically add a route to a network on the server side (Alice). But for Alice to route traffic towards networks on the client sides, other means are needed. The use of static routing is explained here, while dynamic routing (OSFP and RIP) are covered in the next section.

To setup static routes at Alice for to the local networks at Bob and Charlie in [fig. 38.4](#)), the following commands are used.



Example

```
alice:/#> configure
alice:/config/ip/#> route 10.0.2.0/24 10.0.0.2
alice:/config/ip/#> route 10.0.3.0/24 10.0.0.3
alice:/config/ip/#>
```

As seen in this example, the IP address at Bob (10.0.0.2) and Charlie (10.0.0.3) must be known. This can be done either by static IP assignment at Bob and Charlie, or by using dynamically assigning specific addresses using the *CN binding* primitive, see [section 38.1.4.1](#).



Note

Static routing can also be used on clients (Bob and Charlie) to reach networks on the server side (Alice) as an alternative to using **"push-network"**. It can also be used on the clients to reach each other's networks, given that *client to client* communication has been enabled. See [sections 38.1.2.2](#) and [38.1.4.2.4](#) for more information.

38.1.4.2.3 Dynamic routing



Note

In WeOS, use of dynamic routing with SSL VPNs, can only be used with layer-2 VPN tunnels ([section 38.1.3.5](#)).

It is possible to use dynamic routing protocols such as OSPF ([chapter 29](#)) or RIP ([chapter 30](#)) at Alice and Bob to exchange routes. The major benefits are (1) its simple configuration in larger installations, and (2) that it facilitates redundant routing when using multiple tunnels between the sites.

As compared to the example in [section 38.1.2.2](#) (where static routing was used), use of dynamic routing with RIP or OSPF enables the server (Alice) to assign IP addresses to the clients (Bob and Charlie) dynamically.

Below is a sample RIP configuration at Alice ([fig. 38.4](#)), but the setup would be the same at the VPN client (Bob and Charlie). See [chapter 30](#)) for more information.

Example

```
alice:/config/#> router
alice:/config/router/#> rip
alice:/config/router/rip/#> network vlan1
alice:/config/router/rip/#> network ssl0
alice:/config/router/rip/#> leave
alice:/#>
```

To be able to exchange traffic between client networks (Bob and Charlie), the server (Alice) must be configured to allow it, see also [section 38.1.4.2.4](#)

Example

```
alice:/#> configure
alice:/config/#> tunnel
alice:/config/tunnel/#> ssl 0
alice:/config/tunnel/ssl-0/#> client-to-client
alice:/config/tunnel/ssl-0/#> leave
alice:/#>
```

If OSPF is preferred over RIP as dynamic routing protocol, the RIP configuration above could be replaced by the following settings ([fig. 38.4](#)).

Example

```
alice:/#> configure
alice:/config/#> router
alice:/config/router/#> ospf
alice:/config/router/ospf/#> network 10.0.0.0/24 area 0
alice:/config/router/ospf/#> network 10.0.1.0/24 area 0
alice:/config/router/ospf/#> leave
alice:/#>
```

The corresponding setup at the clients Bob and Charlie would only differ in the **"network"** setting specifying the local network (10.0.2.0/24 and 10.0.3.0/24 respectively, instead of 10.0.1.0/24).

Thus, for Bob the OSPF setting would look as below.

Example

```
bob: /#> configure
bob: /config/#> router
bob: /config/router/#> ospf
bob: /config/router/ospf/#> network 10.0.0.0/24 area 0
bob: /config/router/ospf/#> network 10.0.2.0/24 area 0
bob: /config/router/ospf/#> leave
bob: /#>
```

38.1.4.2.4 Managing VPN "client to client" traffic

Note

The description of handling "client to client" traffic in this section assumes clients are connected to the same SSL/OpenVPN instance on the server (Alice). If Alice runs multiple instances, any traffic between clients on different instances is managed by regular routing and firewall rules at Alice.

A VPN server is capable of accepting multiple clients via a single SSL VPN tunnel instance. Each SSL instance on the server can be viewed as an "SSL network", where all traffic to/from VPN clients go via the VPN server, it is possible to configure Alice to allow or deny VPN clients to communicate with each other, see [fig. 38.3](#). Client to client communication is disabled by default.

Communication within an SSL network can be done with or without involving the firewall at the server.

- *Enable client to client communication without involving the firewall:* This alternative is valid both for layer-2 and layer-3 SSL tunnels.

The VPN server (Alice) can enable client-client communication using the SSL **"client-to-client"** setting. She will then forward packets between clients without involving her firewall. This is a simple approach which works both in remote access and site-to-site topologies, thus can be recommended to enable client to client communication when there is no need to limit traffic with firewall filters at the SSL server.

 **Example**

```
alice:/config/#> tunnel
alice:/config/tunnel/#> ssl 0
alice:/config/tunnel/ssl-0/#> client-to-client
alice:/config/tunnel/ssl-0/#> leave
alice:/#>
```

- *Enable client-client traffic via firewall filters:* This alternative is only valid for layer-3 SSL tunnels.

Client-client communication can be enabled by adding appropriate firewall *filter* rules for the given SSL interface. An example is given below. Note that *ssl0* is used both as *incoming* and *outgoing* interface, assuming that both clients (Bob and Charlie) are part of the same SSL network.

 **Example**

```
alice:/config/#> tunnel
alice:/config/tunnel/#> ssl 0
alice:/config/tunnel/ssl-0/#> no client-to-client
alice:/config/tunnel/ssl-0/#> end
alice:/config/tunnel/#> end
alice:/config/#> ip
alice:/config/ip/#> firewall
alice:/config/ip/firewall/#> filter allow in ssl0 out ssl0
alice:/config/ip/firewall/#> leave
alice:/#>
```

The major benefit of managing the client to client communication via the firewall is that it enables the server to control of what traffic to allow and deny.

The drawback is that this cannot be applied to client to client communication when using layer-2 SSL VPNs, where **"client-to-client"** is the only primitive for enabling/disabling client to client communication. As layer-2 SSL VPNs are needed in site-to-site topologies, each client gateway could instead control what traffic to allow/deny by applying appropriate firewall rules. For example, if Bob in [fig. 38.4](#) wish to allow incoming traffic from any node on Alice' subnet (10.0.1.0/24), but only allow a specific address from Charlie's network (here 10.0.3.5), he could be more restrictive on what traffic to allow through his firewall.

Example

```
bob:/config/#> tunnel  
bob:/config/tunnel/#> ssl 0  
bob:/config/ip/firewall/#> filter allow in vlan1 out ssl0  
bob:/config/ip/firewall/#> filter allow in ssl0 src 10.0.1.0/24 out vlan1  
bob:/config/ip/firewall/#> filter allow in ssl0 src 10.0.3.5/32 out vlan1  
bob:/config/ip/firewall/#>
```

38.1.5 SSL Security Settings

SSL security settings include *authentication* settings for tunnel establishment, and *cipher suite* settings (encryption and per packet authentication algorithms) for the SSL tunnel.

38.1.5.1 Authentication of SSL users

WeOS units primarily rely on certificates for authentication. In addition, the server (Alice) can require Bob to provide username and password, which she can match in a local database, or towards a backend authentication server (see *Radia* in figs. 38.2 and 38.4).

Alice and Bob need to install their respective certificate and private key, as well as the certificate of the Certificate Authority (CA) they trust. Typically, a simple PKI model is used where Alice and Bob have their certificates issued by the same CA, see fig. 38.5.

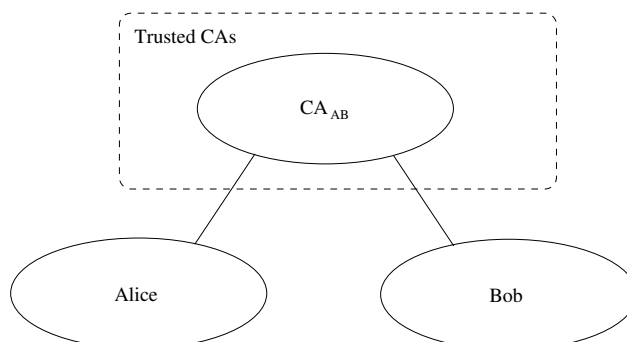



Figure 38.5: Alice and Bob have certificates issued by the same CA (e.g., their company CA). In this PKI model, Alice installs the certificate of her CA, and trusts any certificate issued by that CA.

To generate certificates and private keys for Alice and Bob, you can e.g., use the *Easy-RSA* tools provided by OpenVPN⁴. The easiest way to upload certificates and keys to your WeOS unit(s) is via the WeOS web, see chapter 7.2.5 for more information. It is also possible to install certificates via the CLI. A CLI example is shown below, where Alice installs a PKCS bundle (including Alice' certificate, private key and CA certificate).

⁴OpenVPN home page, <https://openvpn.net> (March 2019).

 **Example**

```
alice:/#> cert import pkcs password "AliceSecret" scp://foo@10.0.1.5/home/foo/alice.p12
Downloading alice.p12 from scp://foo...
foo@10.0.1.5's password:
alice.p12                               100% 3064      3.0KB/s   00:00
Importing certificate alice...
OK
alice:/#> show cert
Type Label          Common Name          Expires
=====
Pub  alice            MyServer             Nov 26 13:35:42 2023 GMT
CA   alice            MyCA                 Nov 26 13:34:19 2023 GMT
Key  alice
alice:/#>
```

With the certificates installed on your WeOS unit, you can configure your SSL tunnel to use them by referring to their label, see the example for Alice below. Until she has configured what certificates to use as her own certificate and her CA certificate, the CLI will give warning messages.

 **Example**

```
alice:/config/#> tunnel
alice:/config/tunnel/#> ssl 0
Creating new SSL tunnel 0, check your settings before activating the tunnel!
ssl0: Invalid settings: No certificate selected.

alice:/config/tunnel/ssl-0/#> certificate alice
ssl0: Invalid settings: No CA certificate selected.

alice:/config/tunnel/ssl-0/#> ca-certificate alice
alice:/config/tunnel/ssl-0/#> leave
alice:/#>
```

With the simple PKI model supported by WeOS (see [fig. 38.5](#)), Alice will accept connections from any VPN client presenting a valid certificate issued by her configured CA. Similarly, Bob (and other VPN clients) will accept certificates presented by the VPN gateway if issued by the CA he has configured.

38.1.5.1.1 Multiple VPN clients sharing the same certificate: Typically, each VPN client will have a unique certificate issued by their CA, but it is also possible for multiple VPN clients (Bob and Charlie) to be configured with the same certificate. In this case the VPN gateway (Alice) must have the **"duplicate-cn"** (duplicate common name) setting enabled. If this setting is *enabled*, she will accept multiple parallel VPN sessions from clients with the certificate, but if it is

disabled (default) she will tear down an existing VPN session if a new session is established with the same certificate; she interprets that as if Bob has moved to a new location.

38.1.5.1.2 Use of username and password to authenticate clients: It is possible for Alice to use a second step authentication by requiring the VPN clients to provide a username and password (in addition to certificate).

SSL clients need to be configured with username and password. The example below shows configuration of these credentials at the VPN client Bob:

Example

```
bob:/config/#> tunnel ssl 0
bob:/config/tunnel/ssl-0/#> identity bob password builder
bob:/config/tunnel/ssl-0/#> leave
bob:/#>
```

Alice will either check these credentials against a local user database or towards a backend server (or server group). Examples for both alternatives are shown below.

- *Local Database:* Configuration at the VPN Gateway (Alice)

Example

```
alice:/config/#> aaa
alice:/config/aaa/#> local-db 1
Creating new local db 1
alice:/config/aaa/local-db-1/#> description openvpn-users
alice:/config/aaa/local-db-1/#> username bob builder
alice:/config/aaa/local-db-1/#> show
Type                : plain
Description         : openvpn-users
Number of users     : 1

Username    Password
-----
bob         builder
alice:/config/aaa/local-db-1/#> end
alice:/config/aaa/#> end
alice:/config/#> tunnel ssl 0
alice:/config/tunnel/ssl-0/#> aaa-method local-db 1
alice:/config/tunnel/ssl-0/#> leave
alice:/#>
```

- *Backend server: Configuration at Alice (VPN Gateway)*

Example

```
alice:/config/#> aaa
alice:/config/aaa/#> remote-server 1
Creating new remote server 1
alice:/config/aaa/remote-server-1/#> address 10.0.1.5
alice:/config/aaa/remote-server-1/#> type radius
alice:/config/aaa/remote-server-1/#> password str4wb3rry
alice:/config/aaa/remote-server-1/#> end
alice:/config/aaa/#> end
alice:/config/#> tunnel ssl 0
alice:/config/tunnel/ssl-0/#> aaa-method remote-server 1
alice:/config/tunnel/ssl-0/#> leave
Configuration activated. Remember "copy run start" to save to flash (NVRAM).
alice:/#>
```

And you also need to setup a backend server (in the example above it is assumed to be located at 10.0.1.5 and be of type RADIUS as in [fig. 38.6](#)). An example is to use a FreeRADIUS server⁵ For TACACS+, an example would be to use a tac_plus server⁶ instead. Some hints for RADIUS are given below.

Example

```
In /etc/freeradius/clients.conf:
client 10.0.1.1 {
    shortname    = 10.0.1.1
    secret       = str4wb3rry
    nastype      = other
}

In /etc/freeradius/users:
bob    Cleartext-password := "builder"
```

38.1.5.2 Cipher Suite Settings

To protect the SSL tunnel, you can chose between a set of data encryption and integrity protection alternatives:

- *Encryption:* WeOS supports various encryption alternatives based on Blowfish, DES and AES. Default is Blowfish (BF-CBC).

⁵See <https://www.freeradius.org> (March 2019) for more information.

⁶See http://www.shrubbery.net/tac_plus/ (March 2019) for more information.

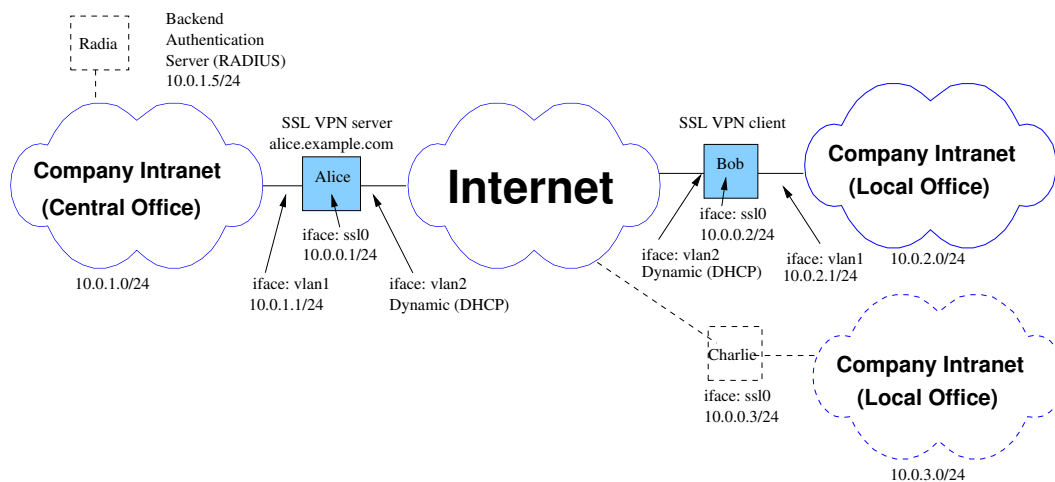

Figure 38.6: VPN Gateway (Alice) can use a backend authentication server (Radia) to check client credentials.

Note

It is recommended to change the encryption protocol to AES-128 or AES-256 for improved security.

The **"crypto"** setting must match on the server and client(s), thus if you change setting, remember to do it on both client and server. The example below gives an example of changing the encryption protocol on the server (Alice).

Example

```
alice:/#> configure
alice:/config/#> tunnel
alice:/config/tunnel/#> ssl 0
alice:/config/tunnel/ssl-0/#> crypto aes-128-cbc
alice:/config/tunnel/ssl-0/#>
```

- **Message Authentication:** WeOS supports SHA1, SHA256 and MD5 for message authentication (message integrity). Default is SHA1.

For improved security, change authentication protocol to SHA256. The setting must match on client and server.

 **Example**

```
alice:/#> configure
alice:/config/#> tunnel
alice:/config/tunnel/#> ssl 0
alice:/config/tunnel/ssl-0/#> auth sha256
alice:/config/tunnel/ssl-0/#>
```

The session keys used for encryption and message integrity is derived as part of the authentication handshake at tunnel establishment. These session keys are renegotiated at a regular interval, which is controlled by the "**renegotiation-timeout**" setting (default 3600 seconds). The lowest timeout value configured by the client or server is used for the SSL VPN session.

38.1.5.3 TLS Authentication Settings

WeOS supports an optional extra authentication of the SSL (TLS) tunnel by using something called "TLS Authentication". This is an extra signature and encryption step performed with a static fixed key. This is done on all control packets for the tunnel, but not for the tunneled data going through the tunnel (this data is encrypted already with the negotiated ciphers and keys). All control packets, including initial communication, received by the SSL VPN server will be checked and decrypted by this mechanism, and packets that does not match will be discarded immediately.

This extra authentication step makes an SSL VPN server less sensitive to DDOS attacks, especially when combined with using the UDP protocol for the tunnel. The server side software will not waste temporary memory by allocating connection data structures (TLS contexts, security associations, etc.) for bad incoming calls.

Using TLS Authentication and UDP together makes the VPN server to be completely quiet if (an attacker's) packets arrive and are not signed by the correct key. Port scanning utilities will not detect the server in this mode.

TLS Authentication works for TCP as well, and has some of the benefits similar to the UDP mode, but the server network stack need to reply to the incoming TCP SYN packet to get a connection before it can determine if the key is valid. A port scanning utility will therefore be able to detect a server in TCP mode, and a heavy DDOS attack may potentially fill up all available connection slots on the server (socket memory/file descriptors).

TLS Authentication requires that a special OpenVPN Static key is imported into the system. The exact same key must be used on both ends of the tunnel for it to connect.

An OpenVPN static key can be generated with a computer with OpenVPN installed. Below is an example command line when using Linux:

Example

```
linux:~/> openvpn --genkey --secret ta-example.key
```

To import the key, use the “cert” command. For details about the certificate store and operations, see [chapter 7.2.5](#).

Example

```
alice:/#> cert import ovpn type key label ta-key ftp://10.0.1.10/ta-example.key  
Downloading ta-example.key from ftp://10.0.1.10...  
Connecting to 10.0.1.10:21 (10.0.1.10:21)  
ta-example.key 100% |*****| 636 0:00:00 ETA  
Importing certificate ta-key...  
OK  
alice:/#>
```

An imported key label is referred from the tunnel configuration, and there is an optional direction label setting that can be used together with the key. Max length of the label is 22 characters.

The key direction setting is either “0” or “1”, and if it is used, the opposite sides of the tunnel need to have different settings for this parameter.

Commonly “0” is used on the server side, and “1” for the client side, but the opposite will also work. A specific key direction is optional, the default is to have the key work in both directions (bi-directional).

Example

```
alice:/config/#> tunnel  
alice:/config/tunnel/#> ssl 0  
alice:/config/tunnel/ssl-0/#> tls-auth label ta-key direction 0  
alice:/config/tunnel/ssl-0/#> leave  
alice:/#>
```

38.1.6 Other relevant setting for SSL VPN units

This section gives hints on other relevant WeOS settings for you SSL/OpenVPN units. Details are found in other chapters of this document.

38.1.6.1 Configuring Date and Time

Having a correct time on the VPN gateways is important. Without a correct system time, Alice and Bob may not be able to verify the certificates used for the OpenVPN tunnel.

It is recommended to use NTP client for time configuration to keep the time in sync. You could use an NTP server within your organisation or on the Internet, e.g., "pool.ntp.org". An example is given below, see [section 22.3.2](#) for more information.

Example

```
alice:/#> configure
alice:/config/#> ntp
alice:/config/ntp/#> server ntp.example.com
alice:/config/ntp/server-ntp.example.com/#> leave
alice:/#>
```

An alternative is to set the date manually, as shown below. The major drawback with this is that the system clock risks to be reset to "Unix 0 Time" (1970-01-01 00:00) if a unit is without power for a couple of days. Use of NTP would handle that automatically and is therefore recommended.

Example

```
alice:/#> date 2018-12-06 12:04
Thu Dec 6 12:04:00 UTC 2018
alice:/#>
```

38.1.6.2 Configuring DDNS

Clients typically wish to connect to the server (Alice) using her domain name, e.g. "**peer alice.example.com**". If Alice is connected to the Internet and receives her IP address dynamically from her ISP (DHCP), she would probably need to use DDNS to handle the domain name to IP mapping. For more information on how to setup DDNS on a WeOS unit, see [section 22.3.3](#).

38.1.6.3 Firewall and NAT

VPN clients and servers typically have their firewall enabled. To allow the intended traffic to flow through the tunnel, suitable *filter allow* rules should be added to your the VPN units. An example for the VPN gateway (Alice) in [figs. 38.2](#) and [38.4](#) is shown below. For site-to-site setups, corresponding filter rules should be added to the clients (Bob and Charlie).

Example

```
alice:/config/#> ip
alice:/config/ip/#> firewall
alice:/config/ip/firewall/#> filter allow in ssl0 out vlan1
alice:/config/ip/firewall/#> filter allow in vlan1 out ssl0
alice:/config/ip/firewall/#> leave
alice:/#>
```

The *allow* rules shown in the example above lets any traffic coming in on the SSL interface to forwarded onto the local network and vice versa. For information on how to setup more fine grain filters, see [chapter 33](#)

The VPN gateway (server Alice, and in site-to-site setups also the clients) is typically used as a NAT gateway towards the Internet (interface *vlan2* in [figs. 38.2](#) and [38.4](#)). Below in an example of NAT configuration.

Example

```
alice:/config/#> ip
alice:/config/ip/#> firewall
alice:/config/ip/firewall/#> nat type napt out vlan2 addfilter
```

To further limit exposure to the Internet, you should block any access to DNS request (port 53) on the WAN interface. (This is not needed if the *domain proxy* proxy feature is disabled, see [section 22.3.4](#).)

Example

```
alice:/config/#> ip
alice:/config/ip/#> firewall
alice:/config/ip/firewall/#> filter deny in vlan2 proto udp dport 53
alice:/config/ip/firewall/#> filter deny in vlan2 proto tcp dport 53
alice:/config/ip/firewall/#> leave
alice:/#>
```

38.1.6.4 Blackhole routes

When the SSL tunnel is down, you wish Alice and Bob to drop any packets destined for the tunnel, avoiding them to be sent on the Internet unencrypted. To ensure they drop the data traffic unless the tunnel is up, you can use *blackhole routes* (section 28.1.4.4). An example for Alice in fig. 38.4 is shown below, but a similar configuration can be used at the VPN client (Bob).

Example

```
alice:/config/#> ip
alice:/config/ip/#> route 10.0.0.0/16 null0 200
alice:/config/ip/#> leave
alice:/#>
```

38.2 Managing SSL VPN settings via the web interface

38.2.1 Manage SSL VPN via the web interface

Menu path: Configuration ⇒ VPN & Tunnel ⇒ SSL VPN

The main SSL VPN configuration pages a list of currently configured SSL VPN tunnels.

SSL

ID	Enabled	Description	Mode	Pool/Peer	
0			Server		

The list shows currently configured SSL VPN tunnels, and displays some of the tunnel settings.

ID	The tunnel index. Each configured tunnel is identified by a number for maintenance purposes. This ID is of local significance only.
Enabled	A green check-mark means enabled and a dash means disabled.
Description	A description for the tunnel.
Mode	Client or Server mode
Edit	Click this icon to edit the settings of a VPN tunnel.
Delete	Click this icon to remove a VPN tunnel. Note: Tunnels which are not intended to be used should either be <i>deleted</i> or <i>disabled</i> (section 38.2.2).

38.2.2 Configure new or existing SSL VPN tunnel via the web interface

Menu path: Configuration ⇒ VPN & Tunnel ⇒ SSL VPN ⇒ **New**



Menu path: Configuration ⇒ VPN & Tunnel ⇒ SSL VPN ⇒  (Instance)

When clicking the **New** button the window to configure a new SSL VPN tunnel appears. To edit an existing tunnel, click on the **Edit** button for the tunnel.



Edit SSL

ID	0
Enabled	<input checked="" type="checkbox"/>
Description	<input type="text"/>
Mode	<input checked="" type="radio"/> Server <input type="radio"/> Client

Network

Type	Layer3 (Routed) ▾				
Protocol	UDP ▾				
Port	1194 ▾				
Outbound Interface	vlan1 ▾				
Pool	<input type="checkbox"/>				
Pushed networks	<input type="checkbox"/>				
Client-to-Client	<input type="checkbox"/>				
Max clients	Limited to:	25			
Common Name binding	<input checked="" type="checkbox"/>	Name	IP Address	Netmask	
		Alice	192.168.33.2	255.255.255.0	
		Bob	192.168.33.3	255.255.255.0	 
Keepalive	Interval	Restart			
	10 s	60 s			
Compression	Adaptive ▾				
Renegotiate	3600 s				

Security

Client AAA	None ▾
Duplicate CN	<input type="checkbox"/>
Crypto	BF-CBC ▾
Authentication Hash	SHA1 ▾
Local Certificate	server1 
CA Certificate	server1 
TLS Auth Key	<input type="text"/> 
Key Direction	Both ▾

Interface

IP Address Enabled	<input checked="" type="checkbox"/>	
IP Address Method	<input checked="" type="radio"/> static <input type="radio"/> dynamic	
IP Address	Address	Netmask
	192.168.33.1	255.255.255.0

General part:

Instance number	The tunnel index. Each configured tunnel is identified by a number for maintenance purposes. This ID is of local significance only.
Enabled	A tunnel can be configured as Enabled or Disabled . Note: Tunnels which are not intended to be used should either be <i>deleted</i> (section 38.2.1) or <i>disabled</i> .
Description	A descriptive text for this tunnel.
Mode	Client or Server mode

Network part:

Type	Set the tunnel to be in Layer2 (Bridged) or Layer3 (Routed) mode. Layer2 is often described as TAP (network tap) and Layer3 as TUN (network tunnel)
Protocol	Protocol to encapsulate the traffic in. TCP or UDP
Port	TCP/UDP listen port.
Outbound Interface	Outbound interface. The tunnel will only connect through the specified interface. If no outbound is specified, the interface which is connected to the default gateway will be used.
Pool (server mode)	IP address to be pushed to all clients connecting to the server. If not set in layer 2 (bridged) mode, the default is to set according to IP class of the start address.
Pushed networks (server mode)	Define networks to push towards all clients.
Client-to-Client (server mode)	Allow clients to communicate with each other.
Max clients (server mode)	How many clients should max be possible to connect to this tunnel if more then this tries to connect, they will be rejected.
Common Name Binding (server mode)	Setup Common Name binding. The X.509 certificate common name to match and the address to assign.
Continued on next page	

Continued from previous page	
Remote peer (client mode)	Remote peer IP address, or DNS domain name. When acting as client, the peer setting defines the remote server to connect to. As server it can be used to allow a single client or not. Use 'no peer' to allow connections from ANY client.
Pull (client mode)	Allow pushed network routes from the server.
Keepalive	Send keep-alive probes over the tunnel to make sure that stateful firewalls gets updated as expected, they is only sent as long as there is no traffic on the tunnel. Interval - The interval to send probes, if there are not traffic on the tunnel Restart - Force restart of the ping probe, this will force reload of DNS for example, this is very useful when dealing with DynDNS (section 22.3.3).
Compression	Set preferred compression setting to be used on the tunnel. In client mode this can be overridden by the server.
Renegotiate	Set the renegotiation time for the data channel, this can be set on both the client and the server, if so, the lowest value will be used.

Security part:

Client AAA (server mode)	Enable authentication of clients using a remote-server, server-group or local database.
Identity (client mode)	Provide authentication when connecting to the server.
Duplicate CN	Allow multiple clients to connect with the same Common Name, without this option it will disconnect a current client when a new connects with the same Common Name.
Crypto	Selects crypto cipher to use.
Authentication Hash	Selects authentication hash to use
Local Certificate	Local certificate to use, including private key
CA Certificate	CA certificate used for signing our certificate, without private key.
TLS Auth Key	TLS authentication key for extended security
Key Direction	Direction for TLS authentication key

Interface part:

IP Address Enabled	Enable IPv4 address on the SSL interface
IP Address Method	Select Method for IPv4 address, static or DHCP
IP Address	The IP address for the SSL interface

38.2.3 View SSL VPN Tunnel Status

Menu path: Status ⇒ VPN & Tunnel ⇒ SSL VPN

The **SSL VPN Status** page lists the status of configured SSL VPN tunnels.

SSL

ID	Description	Mode	Status	Details
0		Server	Down	

Auto-Refresh: Off, [5s](#), [15s](#), [30s](#), [60s](#)

Refresh

Click the **Details** symbol  for a specific tunnel to see more verbose status information.

SSL Tunnel Details - Tunnel 0

```
OpenVPN CLIENT LIST
Updated,Thu Aug 27 09:02:02 2015
Common Name,Real Address,Bytes Received,Bytes Sent,Connected Since
client1,192.168.2.100:57785,3686,3868,Thu Aug 27 09:01:28 2015
ROUTING TABLE
Virtual Address,Common Name,Real Address,Last Ref
GLOBAL STATS
Max bcast/mcast queue length,0
END
```

Auto-Refresh: Off, [5s](#), [15s](#), [30s](#), [60s](#)

Refresh

38.3 Managing SSL VPN settings via the CLI

The WeOS unit can be configured as SSL VPN server gateway (waiting for clients to connect), or as an SSL VPN client (initiating connections). We start out by shown the CLI commands available when configuring an SSL VPN *server* gateway ("**[no] server**" command set to "**server**").

Command	Default	Section
<u>General SSL VPN Server Gateway Settings</u>		
tunnel		Section 37.3.1
[no] ssl <INDEX>		Section 38.3.1
server	Server	Section 38.3.2
[no] enable	Enabled	Section 38.3.3
[no] description <STRING>	Empty	Section 38.3.4
[no] type <layer2 layer3>	layer3	Section 38.3.5
[no] push-network <NETWORK/LEN>	Disabled	Section 38.3.6
[no] pool start <IPADDR> <num <NUM> end <IPADDR>> [netmask NETMASK]	Disabled	Section 38.3.7
[no] cn-binding <IDX>		Section 38.3.8
[no] common-name <STRING>		Section 38.3.9
[no] address <IPADDR/LEN>		Section 38.3.10
<u>Authentication Settings</u>		
[no] certificate	Empty	Section 38.3.12
[no] ca-certificate	Empty	Section 38.3.13
[no] tls-auth label <KEY LABEL> [direction <0 1>]	Empty	Section 38.3.14
[no] aaa-method <remote-server <ID> server-group <ID> local <ID>>	Disabled	Section 38.3.15
<u>Data Security Settings</u>		
[no] crypto <aes-128-cbc . . . >	bf-cbc	Section 38.3.17
[no] auth <sha1 sha256 md5>	sha1	Section 38.3.18
<u>Additional/Advanced Settings</u>		
[no] protocol <tcp udp>	UDP	Section 38.3.19

Continued on next page

Continued from previous page		
Command	Default	Section
[no] port	1194	Section 38.3.20
[no] outbound	Auto	Section 38.3.21
[no] keepalive <interval <SEC> restart <SEC>>	interval 10 restart 60	Section 38.3.22
[no] compression [adaptive]	Adaptive	Section 38.3.23
[no] renegotiation-timeout <SEC>	3600	Section 38.3.24
[no] client-to-client	Disabled	Section 38.3.25
[no] duplicate-cn	Disabled	Section 38.3.26
[no] max-clients <NUM>	25	Section 38.3.27
<u>Show SSL VPN Status</u> show tunnel ssl [ID]		Section 38.3.29
<u>See also (Interface and Firewall Settings)</u>		
iface ssl<ID> inet <static dynamic dhcp> <i>Various Interface settings</i>	Dynamic (SSL) ...	Section 22.6.1 See Sec. 22.6
ip [no] firewall <i>Various Firewall/NAT settings</i>	Disabled ...	Section 33.3.1 See Sec. 33.3

The table below shows the available CLI commands when configuring the WeOS unit as SSL client ("[no] server" command set to "no server").

Command	Default	Section
<u>General SSL VPN Settings</u>		
tunnel		Section 37.3.1
[no] ssl <INDEX>		Section 38.3.1
no server	Server	Section 38.3.2
[no] enable	Enabled	Section 38.3.3
[no] description <STRING>	Empty	Section 38.3.4
[no] type <layer2 layer3>	layer3	Section 38.3.5
[no] peer <ADDRESS DOMAIN>	Empty	Section 38.3.11

Continued on next page

Continued from previous page		
Command	Default	Section
<u>Authentication Settings</u>		
[no] certificate	Empty	Section 38.3.12
[no] ca-certificate	Empty	Section 38.3.13
[no] tls-auth label <KEY LABEL> [direction <0 1>]	Empty	Section 38.3.14
[no] identity <USERNAME> password <PASSWORD>	Disabled	Section 38.3.16
<u>Data Security Settings</u>		
[no] crypto <aes-128-cbc . . . >	bf-cbc	Section 38.3.17
[no] auth <sha1 sha256 md5>	sha1	Section 38.3.18
<u>Additional/Advanced Settings</u>		
[no] protocol <tcp udp>	UDP	Section 38.3.19
[no] port	1194	Section 38.3.20
[no] outbound	Auto	Section 38.3.21
[no] keepalive <interval <SEC> restart <SEC>>	interval 10 restart 60	Section 38.3.22
[no] compression [adaptive]	Adaptive	Section 38.3.23
[no] renegotiation-timeout <SEC>	3600	Section 38.3.24
[no] pull	Enabled	Section 38.3.28
<u>Show SSL VPN Status</u>		
show tunnel ssl [ID]		Section 38.3.29
<u>See also (Interface and Firewall Settings)</u>		
iface ssl<ID> inet <static dynamic dhcp> <i>Various Interface settings</i>	Dynamic (SSL) ...	Section 22.6.1 See Sec. 22.6
ip		
[no] firewall <i>Various Firewall/NAT settings</i>	Disabled ...	Section 33.3.1 See Sec. 33.3

38.3.1 Managing SSL VPN Tunnels

Syntax [no] `ssl <INDEX>` where INDEX is a number greater or equal to 0.

Context [Tunnel Configuration](#) context

Usage Create, delete, or modify an SSL VPN tunnel. Use "`ssl <INDEX>`" to create a new SSL tunnel, or to enter the SSL VPN Configuration context of an existing SSL tunnel. (To find the index of configured tunnels, use "`show tunnel`" as described in [section 37.3.1](#).)

Use "`no ssl <INDEX>`" to remove a specific SSL VPN tunnel, or "`no ssl`" to remove all configured SSL VPN tunnels.

Use "`show ssl <INDEX>`" to show all settings of a specific SSL tunnel (also available as "`show`" command within the SSL VPN Configuration context).



Note

Tunnels which are not intended to be used should either be *deleted* or *disabled* ([section 38.3.3](#)).

Default values Not applicable.

38.3.2 Change tunnel mode (Server/Client)

Syntax [no] `server`

Context [SSL VPN Configuration](#) context

Usage Set the tunnel in server or client mode, use "`no server`" for client mode.

Default values Server

38.3.3 Enable/disable a SSL VPN tunnel

Syntax [no] `enable`

Context [SSL VPN Configuration](#) context

Usage Enable or disable a SSL VPN tunnel. A disabled tunnel will be deactivated, but keeps its configuration settings.

Use "`enable`" to enable and "`no enable`" to disable an SSL VPN tunnel.

Use **"show enable"** to show whether this SSL VPN tunnel is enabled or disabled.



Note

Tunnels which are not intended to be used should either be *deleted* (section 38.3.1) or *disabled*.

Default values Enabled

38.3.4 SSL VPN Description Setting

Syntax [no] description <STRING>

Context [SSL VPN Configuration](#) context

Usage Set or remove the SSL VPN description string.

Use **"description <STRING>"** to set a description for this database.

Use **"no description"** to remove the current description.

Use citation marks around the string if you want to have a description containing space characters.

To view the current description, use **"show description"**.

Default values Empty.

Examples



Example

```
example:/config/tunnel/ssl-19/#> description secrets
or ...
example:/config/tunnel/ssl-19/#> description "Office tunnel"
```

38.3.5 Configure tunnel type

Syntax [no] type <layer2|layer3>

Context [SSL VPN Configuration](#) context

Usage Change which type of tunnel you want to use, select layer2 (sometimes called bridged) or layer3 (sometimes called routed). **"no type"** reset to layer3.

Default values layer3

38.3.6 Push networks to connecting clients

Syntax [no] push-network <NETWORK/LEN>

Context [SSL VPN Configuration](#) context (Only valid when server)

Usage This is a part of the auto-configuration of the clients, push networks (Max is 10) to the clients, these routes will automatically be set as routes to us as long as the client has "pull" enabled.

Default values Disabled

38.3.7 Configure an address pool

Syntax [no] pool start <IPADDR> <num <NUM> | end <IPADDR>> [netmask NETMASK]

Context [SSL VPN Configuration](#) context (Only valid when server)

Usage Auto configure all clients connecting to us, if netmask is omitted it will be set to the default mask for the address class for the start address.

Note

The address of the server interface will be untouched, you will need to configure it manually from the interface context for the ssl-interface [Sec. 22.6.1](#).

Example

```
example:/config/tunnel/ssl-19/#> pool 192.168.253.2 num 10
```

Default values Disabled

38.3.8 Manage Common Name bindings

Syntax [no] cn-binding <INDEX>

Context [SSL VPN Configuration](#) context (Only valid when server)

Usage Create, delete, or modify an SSL Common Name (CN) binding. The SSL CN Binding Configuration context is used to assign specific settings to the SSL client with the given CN in his/her certificate. i.e., a client.

Use **"cn-binding <INDEX>"** to create a new CN binding, or to enter the SSL CN Binding Configuration context of an existing CN binding.

Use **"show cn-binding"** to find the index of all configured bindings, and use **"show cn-binding <INDEX>"** to list information about a specific binding.

Use **"no cn-binding"** to remove all configured bindings, and use **"no cn-binding <INDEX>"** to remove a specific binding.

Default values Not applicable.

38.3.9 Set Common Name for CN binding

Syntax [no] common-name <STRING>

Context [SSL CN Binding Configuration](#) context (Only valid when server)

Usage Declare the CN string to match for this binding.

"common-name <STRING>" sets the string to match against the Common Name in the client's X.509 certificate. Max 64 characters. Valid characters are ASCII 32-126, except '/' (ASCII 47). 'Space' (ASCII 32) cannot be used at the start or end of the string.

"no common-name" deletes the common name setting, but without a defined common name the binding configuration is not valid.

Example

```
alice-server:/config/tunnel/ssl-0/#> cn-binding 1  
Creating new CN binding: 1!  
alice-server:/config/tunnel/ssl-0/cn-binding-1/#> common-name John Smith  
alice-server:/config/tunnel/ssl-0/cn-binding-1/#> address 192.168.5.43/24
```

Default values Not applicable

38.3.10 Set CN specific IP address

Syntax [no] address <IPADDR/LEN>

Context [SSL CN Binding Configuration](#) context (Only valid when server)

Usage Declare the IP address and network prefix length to assign to this VPN client.

Use **"address <IPADDR/LEN>"** to define what IP address and network prefix to assign to the VPN client for this binding.

"no address" deletes the IP address setting, but without a defined IP address the binding configuration is not valid.

Example

```
alice-server:/config/tunnel/ssl-0/#> cn-binding 1
Creating new CN binding: 1!
alice-server:/config/tunnel/ssl-0/cn-binding-1/#> common-name John Smith
alice-server:/config/tunnel/ssl-0/cn-binding-1/#> address 192.168.5.43/24
```

Default values Not applicable

38.3.11 Change remote peer

Syntax [no] peer <ADDRESS|DOMAIN>

Context [SSL VPN Configuration](#) context (Only valid when client)

Usage Set the peer for the client to connect to.

Default values Disabled

38.3.12 Select local certificate

Syntax [no] certificate <LABEL>

Context [SSL VPN Configuration](#) context

Usage Select local certificate (and associated private key), i.e., the certificate by which this unit will authenticate itself. The **"LABEL"** is the reference of the certificate when imported to the WeOS unit. The certificate must be signed off by the CA certificate set in [Section 38.3.13](#) Use **"show certificate"** to show the local certificate setting.

Default values Empty

38.3.13 Select CA certificate

Syntax [no] ca-certificate <LABEL>

Context [SSL VPN Configuration](#) context

Usage Select CA certificate, i.e., the certificate by which this unit will authenticate itself. The **"LABEL"** is the reference of the certificate when imported to the WeOS unit. Use **"show ca-certificate"** to show the CA certificate setting.

Default values Empty

38.3.14 Enable TLS authentication

Syntax [no] tls-auth label <KEY LABEL> [direction <0|1>]

Context [SSL VPN Configuration](#) context

Usage Enable TLS authentication. **"KEY LABEL"** is the label of an OpenVPN key to be used for authentication. The direction is optional and not setting it means to use the key in both directions (bi-directionally).

Default values Empty (disabled)

38.3.15 Configure AAA remote authentication

Syntax [no] aaa-method <remote-server | server-group | local> <ID>

Context [SSL VPN Configuration](#) context

Usage Require an extra authentication after the certificate exchange. Require to first create a remote-server, server-group or a local user database in the AAA context. [Section 9.3](#)



Example

```
example:/config/tunnel/ssl-19/#> aaa-method local 1
or ...
example:/config/tunnel/ssl-19/#> aaa-method remote-server 1
```

Default values Disabled

38.3.16 Configure authentication identity

Syntax [no] identity <USERNAME> password <PASSWORD>

Context [SSL VPN Configuration](#) context (Only valid when client)

Usage This is only required if the server is configured to require an extra authentication layer after the certificate exchange. [Section 38.3.15](#)

 **Example**

```
example:/config/tunnel/ssl-19/#> identity user1 password secrets
```

Default values Disabled

38.3.17 Change cryptographic cipher

Syntax [no] crypto <bf-cbc|des-ede3-cbc|aes-128-cbc|aes-192-cbc|aes-256-cbc>

Context [SSL VPN Configuration](#) context

Usage Set the crypto to use, must match on both the client and the server. **"no crypto"** disables all encryption, all traffic will pass over the tunnel unencrypted.

Default values bf-cbc

38.3.18 Change authentication hash

Syntax [no] auth <sha1|sha256|md5>

Context [SSL VPN Configuration](#) context Authenticate packets with HMAC using message digest. Use **"no auth"** to disable the authentication hash.

Default values sha1

38.3.19 Configure protocol

Syntax [no] protocol <tcp|udp>

Context [SSL VPN Configuration](#) context

Usage Select the protocol to encapsulate the traffic in.

Default values UDP

38.3.20 Configure port

Syntax [no] port <PORT>

Context [SSL VPN Configuration](#) context

Usage In client mode, this selects the port to connect to on the server, in server mode, this selects which port to listen for incoming connections on.

 **Note**

A neat function when using SSL VPN is to listen on TCP ([Section 38.3.19](#)) port 443, this will allow the tunnel to pass almost all firewalls, since the traffic will look like it is HTTPS. To achieve this in server mode you will have to move HTTPS on the WeOS unit to a separate port. See [Section 8.3.29](#).

Default values 1194

38.3.21 Configure Outbound Interface

Syntax [no] outbound <IFACE>

Context [SSL VPN Configuration](#) context

Usage Set the outbound interface of this tunnel.

Use **"no outbound"** to automatically select the interface leading to the *default gateway* as outbound interface.

Use **"show outbound"** to show the configured *outbound interface* for this tunnel. **"Default Gateway"** is shown if the interface leading to the default gateway should be used as outbound interface.

Default values Auto (**"no outbound"**)

38.3.22 Change keepalive settings

Syntax [no] keepalive <interval <SEC> restart <SEC>>

Context [SSL VPN Configuration](#) context

Usage Send keepalive probes over the tunnel to make sure that stateful firewalls gets updated as expected, they is only sent as long as there is no traffic on the tunnel.

- interval - The interval to send probes, if there are not traffic on
- restart - Force restart of the ping probe, this will force reload of DNS for example, this is very useful when dealing with DynDNS ([section 22.3.3](#)).

Note: In server mode, this settings will also be pushed to the clients, if **"pull"** is enabled in the clients, they will not need to configure keepalive settings.

Use **"show keepalive"** to view current keepalive settings.

Default values interval 10 restart 60

38.3.23 Configure compression settings

Syntax [no] compression [adaptive]

Context [SSL VPN Configuration](#) context

Usage Toggle compression settings, **"no compression"** will disable all compression. **"compression adaptive"** will result in that SSL VPN tries to find out if the traffic is encrypted, if not it will encrypt it. This will have performance penalty if all traffic already is encrypted. This setting must match on client and server to get the traffic going. In server mode, this setting will also be pushed to the clients.

Default values Adaptive

38.3.24 Change renegotiation timeout

Syntax [no] renegotiation-timeout <SECONDS>

Context [SSL VPN Configuration](#) context

Usage Set the renegotiation time for the data channel, this can be set on both the client and the server, if so, the lowest value will be used. To disable renegotiation use **"no renegotiation-timeout"** on both ends.

Default values 3600 seconds

38.3.25 Change client to client communication

Syntax [no] client-to-client

Context [SSL VPN Configuration](#) context (Only valid when server)

Usage If enabled all clients will be able to communicated with each other.

Note

No traffic will be passed through the normal network stack, e.g firewall rules will not be possible. If you want the possible to set firewall rules per client you have to create multiple server instance and route between the instances.

Default values Disabled

38.3.26 Allow/deny clients with the same CN

Syntax [no] duplicate-cn

Context [SSL VPN Configuration](#) context (Only valid when server)

Usage The normal behaviour is to deny clients which connect with a CN (common name) that is already connected. Enabling this setting will allow the second connection.

Note

This is a serious security risk, use only if you know what you are doing, you should look to combine this with an aaa-method ([Section 38.3.15](#))

Default values Disabled

38.3.27 Limit number of simultaneous clients

Syntax [no] max-clients <NUM>

Context [SSL VPN Configuration](#) context (Only valid when server)

Usage Use "**max-clients <NUM>**" to define how many clients that are allowed to simultaneously connect to the server. When this number is reached, the server will reject an incoming request.

"no max-clients" (or "**max-clients 0**") means unlimited.

Use "**show max-clients**" to show the current setting.

Note

The "**max-clients**" setting defines the maximum number of clients *allowed* to simultaneously connect. The exact number of connections the server can *handle* can be further limited for performance reasons, as it depends on the platform of your product ([section 1.5](#)), the traffic load of the established tunnels as well as the configuration of your unit.

Default values 25

38.3.28 Change pull settings

Syntax [no] pull

Context [SSL VPN Configuration](#) context (Only valid when client)

Usage In client mode the client may receive routes and ip address from the server. When setting "**no pull**" all these settings the server tries to push, will be discarded.

Default values Enabled

38.3.29 Show SSL Tunnel Status

Syntax show tunnel ssl [ID]

Context [Admin Exec](#) context.

Usage Show the status for all or for a specific SSL tunnel.

Default values If no tunnel ID is specified, the status of all SSL tunnels is shown.

38.4 Feature Parameters

MAX_SSL_INSTANCES	3
MAX_SSL_PUSH_SUBNETS	10
MAX_SSL_CN_BIND_INST	100

Chapter 39

WeConnect

This chapter describes the WeOS support for the Westermo WeConnect service. Westermo WeConnect is a centralised on-line connectivity service offered by Westermo as a separate product (not normally included in the purchase of a WeOS product).

The idea of the service is to connect equipment and networks through the Internet in an easy way, but at the same time safe and encrypted using standard VPN features.

The secured networks set up by WeConnect can be used in many ways such as remote management, interconnection of remote network locations, centralised logging and alerts, emergency access, etc.

WeConnect is managed with an on-line web portal. In this portal you are able to define your virtual secure networks and create VPN configurations for WeOS units and other clients and nodes. For more information about the service and how to sign up for it, please visit Westermo's home page at <http://www.westermo.com/>.

In WeOS, WeConnect is set up using an installer that takes you through some easy steps that takes care of the configuration for you.

You only need the Secure Network Code and the One Time Password (OTP) for your unit from the WeConnect web portal to be able to run the installer. WeOS will use the Code and OTP to make an encrypted download of the configuration and certificates from the on-line portal service. The VPN will automatically connect when the installer procedure is completed and your unit instantly becomes part of your secured network.

WeConnect utilises these standard features in WeOS for its operations:

- *SSL VPN* - This is used for the encrypted tunnel that connects to your WeConnect secure network.
- *RIP* - This protocol is run inside the SSL VPN tunnel to receive routes from other units and networks in the secure network. It also announces the local networks on your unit so they can be reached remotely.
- *Firewall* - Automatic forward rules for the WeConnect SSL VPN tunnel are added. It is recommended that you use the firewall, but not mandatory.

The SSL VPN tunnel is run in UDP mode. This makes the WeConnect service perform well on most types of Internet connections. There is no requirement of fixed public IP number for your unit, and accessing the Internet via external firewalls and NAT will work in most cases.



Note

WeConnect is using the IPv4 networks **198.18.0.0/16** and **198.19.0.0/16** internally for its operation. You can not use these networks, or subnets within these networks, for other purposes on your WeOS unit while using WeConnect.

39.1 Installing WeConnect via the Web



Menu path: WeConnect

When you enter the WeConnect installer, you will be greeted by an introductory text and these input fields:

Current Time		<input type="button" value="Check"/>
Internet connectivity	Press check	<input type="button" value="Check"/>
Local Interfaces	vlan2  <input type="text" value=""/> <input type="button" value="Add"/>	<input type="button" value="Add"/>
Secure Network Code	<input type="text" value=""/>	<input type="button" value="Setup"/>
One Time Password	<input type="text" value=""/>	<input type="button" value="Setup"/>

The first thing to do is to click the **Check** button. This will test the connectivity to Internet and the WeConnect portal, and to check that the local time on your unit is properly set.

If all goes well with the check, the rest of the input fields will be enabled:

Current Time	Wed Jan 14 12:22:29 2015	<input type="button" value="Check"/>
Internet connectivity	 Ok	<input type="button" value="Check"/>
Local Interfaces	vlan2  <input type="text" value=""/> <input type="button" value="Add"/>	<input type="button" value="Add"/>
Secure Network Code	<input type="text" value=""/>	<input type="button" value="Setup"/>
One Time Password	<input type="text" value=""/>	<input type="button" value="Setup"/>

Please see the troubleshooting section if you get stuck on an error message during this guide ([section 39.3](#)).

By default, all VLAN interfaces except for the interface that connects to Internet are added and exported into WeConnect (in the example above, vlan2 will be exported). You can remove and add interfaces manually using the delete icon , and the interface select menu together with the **Add** button.

Enter the **Secure Network Code** and **One Time Password** obtained from the WeConnect on-line portal:

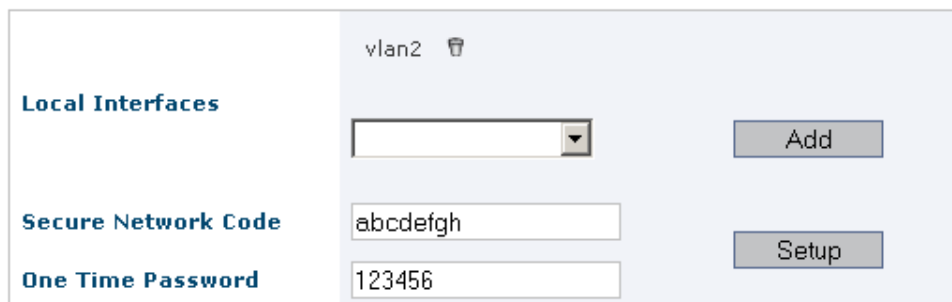

The screenshot shows a configuration panel for 'vlan2'. It includes a 'Local Interfaces' section with a dropdown menu and an 'Add' button. Below this, there are two input fields: 'Secure Network Code' with the value 'abcdefgh' and 'One Time Password' with the value '123456'. A 'Setup' button is located to the right of these fields.

Click **Setup**. This downloads and installs the configuration and certificates that enables WeConnect on your unit.

This is shown at the top of the page if everything went OK:

Changes successfully applied.

WeConnect

The setup is now complete, and the unit will connect to your secure network automatically.

After installing WeConnect you can go to the WeConnect page again via the menu to see the status of the SSL VPN tunnel. Example, with the tunnel up:

The tunnel SSL 253 already exist, you need to remove it to run the WeConnect Setup..

ID	Description	Mode	Status
253		Client	Up (0 Days 0 Hours 1 Mins 14 Secs)

The warning message shown above the status information does not indicate an error, but serves as a notification that WeConnect is already set up and the installer can not be run again.

WeConnect uses the SSL VPN tunnel ID 253, and you can also find tunnel status

via the ordinary status menu "Status ⇒ VPN & Tunnel ⇒ SSL", see [section 38.2.3](#).

39.2 Installing WeConnect via the CLI

WeConnect in the CLI is not set up in the normal configuration mode, but as a command of its own ("**weconnect**") in the [Admin Exec](#) context.

Example

```
example:/#> weconnect
```

```
=====
Welcome to Westermo WeConnect!
=====
```

```
WeConnect allows secure remote access to both the network behind the WeOS
devices and the devices themselves. WeConnect solves the complexity of
managing VPNs over the internet.
```

```
With WeConnect users can easily and securely connect to any IP-device on
the network using their normal PC, smartphone or tablet.
```

```
If you do not yet have an account, contact your local Westermo reseller or
visit http://www.westermo.com/ for further information.
```

```
This installation procedure will download configurations and certificates
for connecting to the Westermo WeConnect service.
```

```
Certificates will be installed and the current running configuration will
be changed and saved as startup configuration as part of this procedure.
```

```
Do you want to continue (y/N)?
```

Enter "**y**" here to continue.

At this point the installer will test the connectivity to Internet and that the WeConnect portal can be reached. The local time on your unit is also checked so that it is properly set. Please see the troubleshooting section if you get stuck on an error message during the install ([section 39.3](#)).

If all goes well with the checks, you will be asked to enter the **Secure Network Code** and **One Time Password** obtained from the WeConnect on-line portal.

Example

```
Please enter the identification information provided by the WeConnect web
portal.
```

```
Secure Network Code: abcdefgh
```

One Time Password: **123456**

Please specify a list of the interfaces that will be shared over WeConnect.
[vlan2, vlan3]:

You are asked to enter which interfaces that should be exported into WeConnect. By default, all VLAN interfaces except for the interface that connects to Internet are suggested inside square brackets at the prompt (in the example above: vlan2 and vlan3). If the suggested list is OK, just press enter to continue.

If you want to add or remove any interface to the list, you should manually enter the *whole list* of interfaces that you want to be exported into WeConnect, separated with commas.

To export interfaces vlan3 and gre2 (but not vlan2):

Example

Please specify a list of the interfaces that will be shared over WeConnect.
[vlan2, vlan3]: **vlan3, gre2**

After this, the configuration and certificates for WeConnect will be downloaded and installed on your unit.

Example

Downloading and installing configuration and certificates. Please wait...
Installation OK

WeConnect installation complete!

The SSL tunnel status can be viewed with the command:
show tunnel ssl 253

The WeOS configuration was changed as part of the installation.

Run "copy run start" to save to flash (NVRAM).

Starting RIP daemon [OK]
Starting SSL tunnel daemon [OK]

The configuration is changed but is *not* saved permanently.

Note

It is possible at this point to undo the configuration by rebooting, or copying a saved configuration to "running-config", but this will not remove the installed certificate for the VPN tunnel. The certificate needs to be manually deleted to completely undo the install. (See [section 7.2.5](#) for more information on certificate management.)

Do not forget to save the settings

Example

```
example: /#> copy running-config startup-config
```

The setup is now complete, and the unit will connect to your secure network automatically. Use the command **"show tunnel ssl 253"** to see the status of the tunnel.

39.3 Troubleshooting

These are error messages that you may get while running the installer.

39.3.1 At least two interfaces needed

You will need at least two interfaces for WeConnect to work. One of the interfaces is the uplink used to connect to Internet. You will not have much use of WeConnect if you do not have at least one additional interface that is exported to the secure network.

39.3.2 Unable to connect to the WeConnect servers

This message usually means that you can not reach the Internet. You need to configure your unit so that it has Internet access in some way. Please check that you have got a DHCP lease, or if configuring IP settings manually, that you have a proper IP address and netmask, a default route, and a name server (DNS) configured.

The download of configuration and certificates is using HTTPS (TCP port 443) to access the on-line servers. If you are behind a firewall, please make sure it does not block this port for outbound connections. (And while you are at it, you should also check that outbound UDP traffic to port 1194 is allowed as that will be used for the SSL VPN tunnel later.)

39.3.3 The system time is incorrect

The SSL VPN functionality is using certificates for authentication. These certificates are valid for a defined time range (WeConnect certificates are normally

valid for several years). It is important that the system time is correctly set to the current time as the tunnel will not be established if the time is outside the validity time range of the certificate.

A WeOS unit that has been stored for a long time without power attached may reset the internal clock. The internal power source (similar to a battery) is slowly drained.

You need to manually set the current time in the unit, or even better, configure NTP to automatically set the time from a time server.

39.3.4 The connection to the WeConnect download service was interrupted

This error message is shown if one of these things occurred:

- You entered incorrect information for Secure Network Code or One Time Password.
- The One Time Password had already been used before.
- The Internet connection went away before or during the file transfer.
- The downloaded file was corrupted during the transfer.
- The WeConnect servers had some kind of problem.

Please check that you have the correct ID and password, and re-run the WeConnect installation. If the information seems OK but still does not work, you can try generating a new one time password in the WeConnect portal and re-run the installation.

39.3.5 RIP is already configured

WeConnect uses RIP for handling routes inside a secure network. RIP must not be configured previously when running the installer. You may add your own RIP settings after the installer, but this is not recommended. All routes picked up by RIP will propagate to the WeConnect secure network. If you need dynamic routing for other purposes, please consider using OSPF for that, and keep RIP exclusive for WeConnect.

You may also get this error message if WeConnect is already installed.

39.3.6 The tunnel SSL 253 already exist

This means that WeConnect is already installed. The special tunnel number 253 is used exclusively for WeConnect.

39.3.7 TFTP is very slow over WeConnect

The traffic sent from one node is put into a VPN tunnel that is terminating at Westermo's WeConnect servers on the Internet. It is then re-routed to the target node via the target node's VPN tunnel. This causes a high latency for the traffic going back and forth via this service. High latency is very harmful for TFTP performance as explained in the note in [section 7.1.1.1.2](#).

A WeOS firmware update using a PKG file, using TFTP and going via WeConnect typically takes several hours due to the latency. Please avoid using TFTP at all over WeConnect. Other protocols such as FTP, HTTP and SSH use TCP and these protocols work a lot better for transferring files.

39.3.8 I need to remove or reinstall WeConnect

To reinstall, you should first remove the old settings, and then run the installer again.

There is no automated way of removing WeConnect, it has to be done manually. Easiest way is to do a factory reset on your unit, but sometimes that is not an option.

Restoring an old configuration that was saved before you installed WeConnect is one way. But this procedure will not remove the WeConnect certificates and keys. You need to manually remove these.

If you need to manually remove WeConnect but keep all other configuration as it is, you should do these steps:

- Delete the SSL VPN tunnel with ID 253.
- Delete RIP configuration.
- Delete WeConnect related certificates and keys.
- If you have the firewall enabled, you may need to remove firewall forward filter rules that are related to interface ssl253.

Part V

Serial Port Management and Applications

Chapter 40

Serial Port Management

This chapter describes serial port features and management support in WeOS, thus only apply to WeOS products equipped with serial port(s). WeOS products can be equipped with three types of serial ports:

- *RS-232 serial port*: Serial ports that support RS-232.
- *"Combo" RS-232/422/485 serial ports*: Serial ports capable of using RS-232, RS-422 and RS-485 as serial protocol. The user can select the type of serial protocol to run.
- *"Combo" RS-422/485 serial ports*: Serial ports capable of using RS-422 and RS-485 as serial protocol. The user can select the type of serial protocol to run.

For details on the serial port capabilities and pin-out of your specific WeOS product, please see the User Guide of the product ([section 1.5](#)).

The serial port can be used by several different serial applications:

- *Serial extender*: The WeOS units with serial ports can be used to extend a serial connection over a TCP/IP network. [Chapter 41](#) provides information on WeOS *Serial Over IP* support.
- *Modem replacement*: WeOS units are able to interpret AT commands, the can be used to replace modems. The *modem replacement* support is integrated with WeOS *Serial Over IP* functions, and is described in [chapter 41](#).
- *Modbus gateway*: WeOS units can act as gateway between Modbus units on the serial port and Modbus units on TCP/IP networks. [Chapter 42](#) describes WeOS Modbus gateway support.

- *Microlok gateway*: WeOS units can act as gateway between Microlok units on the serial port and Microlok units on UDP/IP networks. [Chapter 43](#) describes WeOS Microlok gateway support.
- *PPP network interface*: For WeOS units with proper software level, the serial port can be used to establish PPP connections, with or without external modem. See [chapter 35](#) for more information.

40.1 Overview of Serial Port Management

The table below presents the serial port management features in WeOS.

Feature	Web	CLI	General Description
Enable/disable Serial Port ¹	X	X	
Select type (RS-232/422/485) ²	X	X	
Speed	X	X	Section 40.1.1
Data bits	X	X	-"
Parity	X	X	-"
Stop bits	X	X	-"
Hardware flow control ³	X	X	Section 40.1.2
Software flow control	X	X	Section 40.1.3
Termination ²	X	X	



Note

For details on RS-422 or RS-485 pinouts, see the User Guide of your specific product (listed in [Chapter 1](#)). For background information on RS-422 and RS-485 technology and applications, see the Westermo Handbook 5.0[[67](#)] (pages 29-30).

40.1.1 Serial Port Settings

The serial port settings include the following parameters:

¹Only applicable to "combo" RS-232/422/485 ports. "Regular" serial ports only supporting RS-232, as well as "combo" RS-422/485 ports, are always enabled.

²Only applicable for ports with RS-422/485 support, either the "combo" RS-232/422/485 or the "combo" RS-422/485

³Hardware flow-control is only applicable for ports running in RS-232 mode.

- *Speed*: Set serial port data rate (bits/s).
 - Possible data rates for RS-232 (and RS-422/485) are: 50, 75, 110, 134, 150, 200, 300, 600, 1200, 2400, 4800, 9600, 19200, 38400, 57600, 115200 bits/s
 - Additional data rates for RS-422/485 : 230400, 315000, 460800, 500000, 576000, 615000, 921600, 1000000, 1152000, 1500000, 2000000 bits/s

Default: **115200 bits/s**

- *Data character*:

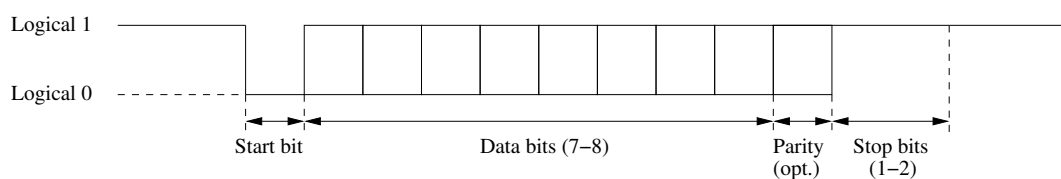

- *Data bits*: Number of data bits per character. Possible values are 7-8 bits. Default: **8 data bits**
 - *Parity*: Parity error detection setting. Possible settings are *none* (no parity checking), *even* and *odd* parity checking. When configured to use even (or odd) parity, an additional bit (the parity bit) is transmitted after the data bits to enforce that an even (or odd, respectively) number of 1's are sent, thereby enabling the receiver to detect single bit errors. Default: **No parity**
 - *Stop bits*: Number of stop bits. Possible values are 1 and 2 bits. The stop bits define the interval until the next character can be transmitted, and are sent as logical 1 (compare with the *start bit*, which is sent as a logical 0). Default: **1 stop bit**
- *Flow control*
 - *Hardware flow control*: (RS-232 only) Hardware flow control using RTS/CTS. Explained further in [section 40.1.2](#). Default: **Disabled**
 - *Software flow control*: Software flow control using XON/XOFF. Explained further in [section 40.1.3](#). Default: **Disabled**

40.1.2 Hardware flow control using RTS/CTS

RS-232 serial ports can use the request to send (RTS) and clear to send (CTS) pins to enforce flow control over the serial line. The DTE will assert the RTS to indicate

to the DCE that it has data to send, and the DCE will respond by asserting the CTS when it is ready to receive data.

Similarly, the DCE asserts the CTS when it has data to send, and the DTE will respond by asserting RTS to give the DCE permission to send. The extension to allow the flow-control to work both ways is referred to as *RTS/CTS handshaking* and was not included in the original RS-232 standard.

Serial ports on WeOS devices are typically RS-232 ports using RJ-45 sockets (EIA/TIA-561) in DCE mode, as shown in [fig. 40.1](#) (for a definite description of the serial port on your Westermo device, see the associated product User Guide).

<u>Signal</u>	<u>Acronym</u>	<u>Dir (DCE)</u>	<u>Nb</u>
Request To Send	RTS	In	8
Clear To Send	CTS	Out	7
Transmitted Data	TD	In	6
Received Data	RD	Out	5
Signal Ground	SG		4
Data Terminal Ready	DTR	In	3
Data Carrier Detect	DCD	Out	2
Data Set Ready	DSR	Out	1

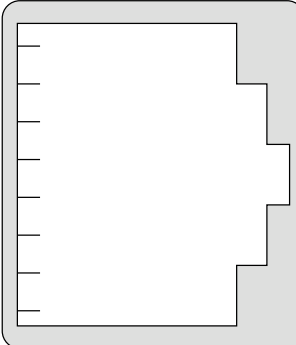

Figure 40.1: Typical RS-232 serial port on WeOS devices – RJ-45 socket (EIA/TIA-561) in DCE mode.

40.1.3 Software flow control using XON/XOFF

An alternative to hardware flow control is to use software flow control, which does not require the presence of the RTS and CTS pins. With software flow control (XON/XOFF) the receiver can stop the sender by transmitting a special character (XOFF, ASCII 19) over the data line. Once the receiver is ready to receive more data it transmits an XON character (ASCII 17).

40.2 Managing serial ports via the web interface

The Web interface provides configuration of serial ports.

40.2.1 Serial ports overview

Menu path: Configuration ⇒ Serial ⇒ Port

Serial Port

Port	Type	Settings	
1	rs485	300 7, None, 1	
2	rs232	1200 8, Even, 1	

Figure 40.2: Serial port configuration settings overview

40.2.2 Edit Serial Port Settings

Menu path: Configuration ⇒ Serial ⇒ Port ⇒ 

Serial Port 1

Enabled	<input checked="" type="checkbox"/>
Type	rs422
Speed	921600
Data Bits	8
Parity	None
Stop Bits	1
HW Flow Control	None
SW Flow Control	None
Termination	Tx

Apply

Cancel

On this page you can change the settings for the serial port.

Type	Enable/disable the serial port by checking/unchecking this checkbox.
Type	Select serial interface type. Selections only available if multiple interface types are supported by hardware.
Speed	Set serial port data rate.
Data bits	Set the number of data bits
Parity	Set parity error detection
Stop bits	Set the number of stop bits
HW flow control	Enable/disable hardware flow control using RTS/CTS
SW flow control	Enable/disable software flow control using XON/XOFF
Termination	Select serial interface termination for RS422 and RS485.

40.2.3 Serial Port Status

Menu path: Status ⇒ Serial ⇒ Port

Port	Active Configuration				Service	Bytes Count		Signals			
	Type	Enabled	Settings			TD	RD	RTS	CTS	DTR	DSR
1	rs232		115200 8, None, 1		unused	0	0				
2	rs232		115200 8, None, 1		seroip1	2381	137				

Auto-Refresh: Off, 5s, 15s, 30s, 60s

Port	The port label
Type	Type of port, rs-232, rs-422 or rs-485
Enabled	Shows if the port is enabled
Settings	Show active port settings
Service	Shows what service controls the port.
Byte count	Displays the total byte count, in (TD) and out (RD)
Signals	Displays the status signals, in (CTS, DSR) and out (RTS, DTR)
Auto Refresh	Click on a value to make the page reload with updated statistics automatically every 5, 15, 30 or 60 seconds. Click Off to turn off auto refresh.
Refresh	Click on this button to reload with updated statistics.

40.3 Managing serial ports via the CLI interface

The table below shows serial port management features available via the CLI.

Command	Default	Section
<u>Configure common serial port settings</u>		
port [serial . . .] <PORTLIST>		Section 40.3.1
[no] speed <50-2000000>	115200	Section 40.3.2
[no] databits <7-8>	8	Section 40.3.3
[no] parity	Disabled	Section 40.3.4
[no] stopbits	1	Section 40.3.5
[no] xonxoff	Disabled	Section 40.3.6
<u>Configure settings specific to RS-232</u>		
[no] rtscts	Disabled	Section 40.3.7
<u>Configure settings specific to RS-232/422/485 and RS-422/485 combo ports</u>		
[no] type <rs232 rs422 rs485>	<i>Differs</i> ¹	Section 40.3.8
[no] terminate [rx] [tx]	Disabled	Section 40.3.9
<u>Configure settings specific to RS-232/422/485 combo ports</u>		
[no] enable	Disabled	Section 40.3.10
<u>Show serial port status</u>		
show port serial [PORTLIST]		Section 40.3.11

¹Default for RS-232/422/485 "combo" ports is "rs232", while default for RS-422/485 "combo" ports is "rs485".

40.3.1 Managing serial port settings

Syntax port [serial|...] <PORTLIST>

Context [Global Configuration](#) context

Usage Enter the Serial Port Configuration context for the given port.

A **"PORTLIST"** is a comma separated list of ranges of serial ports without intermediate spaces, e.g., **"1/1,1/2"** on a *slotted* product, or **"1-3,5"** on a *non-slotted* product.

The port qualifier keyword **"serial"** is not needed if the numbers in the **"PORTLIST"** are unique to serial ports.

Use **"show port serial <PORTID>"** to show all configuration settings for a given serial port (also available as **"show"** command within the Serial Port Configuration context).

For a more general description of the **"port"** command, see [section 10.3.1](#).

Default value Not applicable.

40.3.2 Setting port speed

Syntax [no] speed <300-2000000>

Context [Serial Port Configuration](#) context

Usage Set serial port data rate.

- Possible data rates for RS-232 (and RS-422/485) are: 50, 75, 110, 134, 150, 200, 300, 600, 1200, 2400, 4800, 9600, 19200, 38400, 57600, 115200 bits/s
- Additional data rates for RS-422/485 : 230400, 315000, 460800, 500000, 576000, 615000, 921600, 1000000, 1152000, 1500000, 2000000 bits/s

Use **"no speed"** to reset the serial port data rate to the default setting.

Use **"show speed"** to show the serial port speed setting.

Default value 115200 (bits/s)

40.3.3 Setting number of data bits

Syntax [no] databits <7-8>

Context [Serial Port Configuration](#) context

Usage Set the number number of data bits.

Use **"no databits"** to reset the number of data bits to the default setting.

Use **"show databits"** to show the configured number of databits for this serial port.

Default value 8

40.3.4 Setting parity error detection

Syntax [no] parity <odd|even>

Context [Serial Port Configuration](#) context

Usage Set parity error detection. Use command **"parity odd"** to specify *odd* parity, or **"parity even"** to specify *even* parity on this serial port.

Use **"no parity"** to disable parity checking on this port.

Use **"show parity"** to show the parity checking setting for this port: *None* (i.e., Disabled), *Odd*, or *Even*.

Default value Disabled (no parity).

40.3.5 Setting number of stop bits

Syntax [no] stopbits <1|2>

Context [Serial Port Configuration](#) context

Usage Set the number number of stop bits (1 or 2).

Use **"no stopbits"** reset the number of stop bits to the default setting.

Use **"show stopbits"** to show the configured number of stopbits for this serial port.

Default value 1

40.3.6 Setting Software flow control (XON/XOFF)

Syntax [no] xonxoff

Context [Serial Port Configuration](#) context

Usage Enable/disable software flow control using XON/XOFF

Use "**show xonxoff**" to show the software flow control setting (XON/XOFF) for this serial port.

Default value Disabled (no xonxoff)

40.3.7 Setting Hardware flow control (RTS/CTS)

Syntax [no] rtscts

Context [Serial Port Configuration](#) context (only applicable when the serial port is operating in RS-232 mode)

Usage Enable/disable hardware flow control using RTS/CTS.

Use "**show rtscts**" to show the hardware flow control setting (RTS/CTS) for this serial port.

Default value Disabled (no rtscts)

40.3.8 Selecting serial protocol for a serial (combo) port

Syntax [no] type <rs232|rs422|rs485>

Context [Serial Port Configuration](#) context (Only applicable to *RS-232/422/485* and *RS-422/485* "combo" serial ports.)

Usage Select serial protocol to use for a serial (combo) port. Use, e.g., "**type rs422**" to make a port operate in RS-422 mode. "**no type**" resets to the default type (RS-232 for RS-232/422/485 ports and RS-485 for RS-422/485 ports).

Use "**show type**" to show whether the serial (combo) port is configured in RS-232, RS-422, or RS-485 mode. (This is only of major interest for combo *RS-232/422/485* and *RS-422/485* serial ports - a "regular" RS-232 serial port cannot be set to anything but RS-232.)

Default value RS-232 for "combo" RS-232/422/485 ports and RS-485 for "combo" RS-422/485 ports.

40.3.9 Configure serial port termination

Syntax [no] terminate [rx] [tx]

Context [Serial Port Configuration](#) context (*RS-422 and RS-485* modes only)

Usage Configure serial port termination setting. The termination setting is only applicable for ports operating in RS-422 or RS-485 mode.

- *RS-422 (4-wire)*: Use **"terminate rx"** to enable termination on the receive pair, **"terminate tx"** to enable termination on the transmit pair, and **"terminate rx,tx"** to enable termination on both the receive and transmit pairs. **"no terminate"** will disable termination.
- *RS-485 (2-wire)*: Use **"terminate"** to enable termination and **"no terminate"** to disable termination.

Use **"show "** to shether termination is enabled or disabled. In RS-422 mode, the port pairs, for which termination is enabled, are listed (RX, TX, or both RX and TX).

Default value Disabled (no terminate)

40.3.10 Enabling/disabling a serial (RS-232/422/485 "combo") port

Syntax [no] enable

Context [Serial Port Configuration](#) context

Usage Enable/disable a serial port. (Only applicable to "combo" RS-232/422/485 serial ports. Regular RS-232 ports and "combo" RS-422/485 serial ports are always enabled.)

Use **"show enable"** to show whether the "combo" RS-232/422/485 serial port is enabled or disabled.

Default value Disabled (no enable)

40.3.11 Show Serial Port Status

Syntax show port serial [PORTLIST]

Context [Admin Exec](#) context

Usage Show status of one or all serial ports. Use **"show port serial"** to list status *summary* of all serial ports on the unit. Use **"show port serial PORTLIST"** (e.g., *show port serial 1* to list *detailed* status information on a specific serial port (or list of ports).

Default value If no PORTID is given, a status *summary* of all serial ports is listed.

Chapter 41

Serial Over IP

This chapter describes the *Serial Over IP* application available on WeOS products equipped with a serial port. *Serial over IP* enables you to:

- extend an existing serial communication channel over an intermediate IP network.
- create a virtual serial port for remote access from a PC.
- replace an analog modem with a WeOS unit (AT command mode).

For information on serial port configuration (data rate, data bits, etc.), see [chapter 40](#).

41.1 Overview of Serial Over IP

An overview of Serial Over IP features in WeOS is presented in the table below.

Feature	Web	CLI	General Description
Mode (server, client, peer, or AT command)	X	X	Sections 41.1.1-41.1.2
Protocol Extensions	X	X	Sections 41.1.1.3 and 41.1.2
Packing of Data	X	X	Sections 41.1.2 and 41.1.3
Frame separator	X	X	Sections 41.1.2 and 41.1.3
Frame size	X	X	Sections 41.1.2 and 41.1.3
Frame delay	X	X	Sections 41.1.2 and 41.1.3

Continued on next page

Continued from previous page			
Feature	Web	CLI	General Description
Select Serial Port	X	X	Section 41.1.2
Addressing/Port Settings	X	X	-"-
Receiving (incl. multicast)	X	X	-"-
Sending (incl. multicast)	X	X	-"-
Modem Replacement / AT command interpreter Priority	X	X	Sections 41.1.1.4 and 41.1.2, Sections 41.1.4 and 41.1.5 Sections 41.3.7

41.1.1 Serial Over IP introduction

The *Serial Over IP* application can be used in several ways, but the use cases can be divided into four typical applications:

- Serial point-to-point
- Serial one-to-many (typically a Master-slaves application)
- PC access to remote serial devices.
- Modem replacement

41.1.1.1 Point-to-point

In this way two serial devices can communicate over an IP network. It can be set up either as a client-server configuration using TCP, and as two peers using UDP.



Figure 41.1: Serial Point-to-point link

41.1.1.2 One-to-many

This allows one serial device (typically a master) to communicate with multiple serial devices using UDP transport. It can be set up as IP broadcast, IP multicast, or via multiple IP unicast streams.

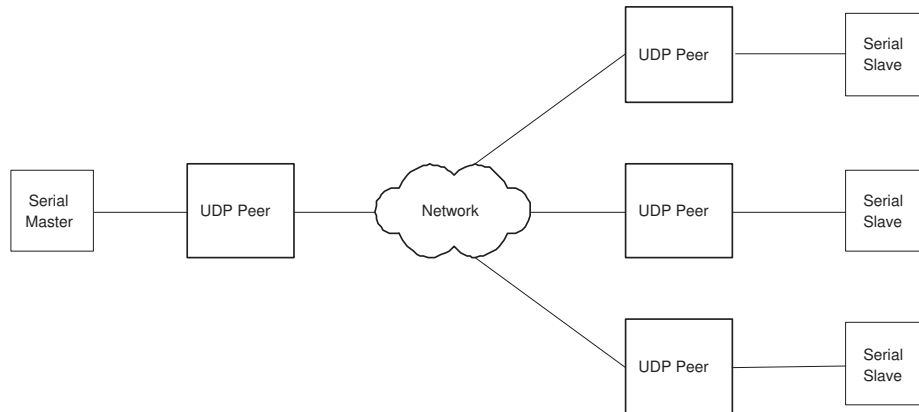

Figure 41.2: Serial one to many

Another one-to-many option is the *server-multipoint* mode where multiple TCP clients can connect to the same port on a TCP server. Traffic received on any TCP connection is forwarded to the server’s serial port. Traffic coming in on the serial port is forwarded/copied to every TCP connection by the server.

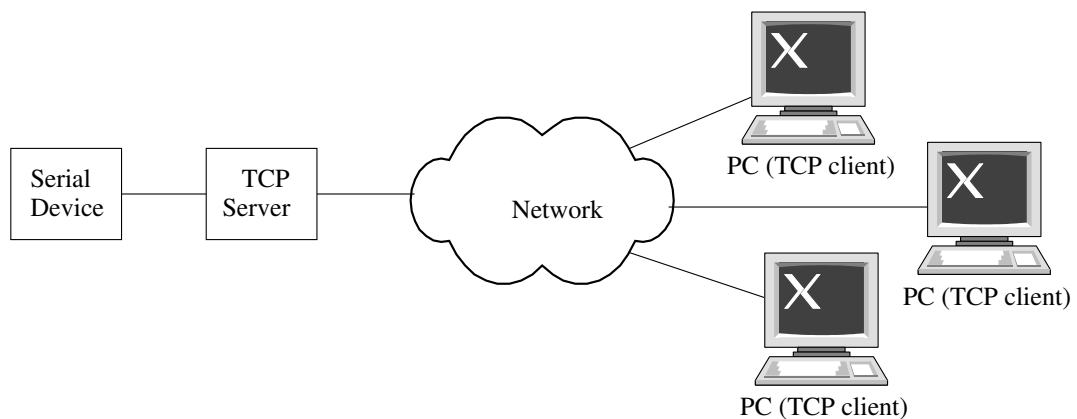

Figure 41.3: Server multipoint

41.1.1.3 Serial Port Redirector (Virtual Serial Port)

By using a serial port redirector software, an application can access remote serial devices as if they were directly connected to the PC. Westermo provides a OEM version Serial/IP^{®1} that allows up to 10 virtual serial port to be created. Note: the OEM version of Serial/IP[®] requires that telnet protocol extension is enabled to verify the license. There is also a possibility for an application to directly connect to the Serial Over IP.

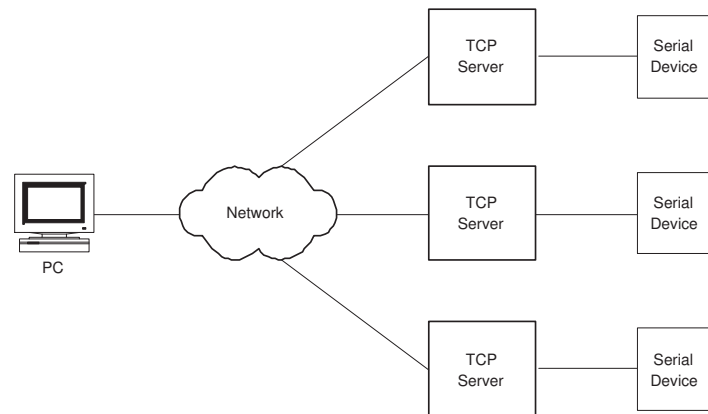
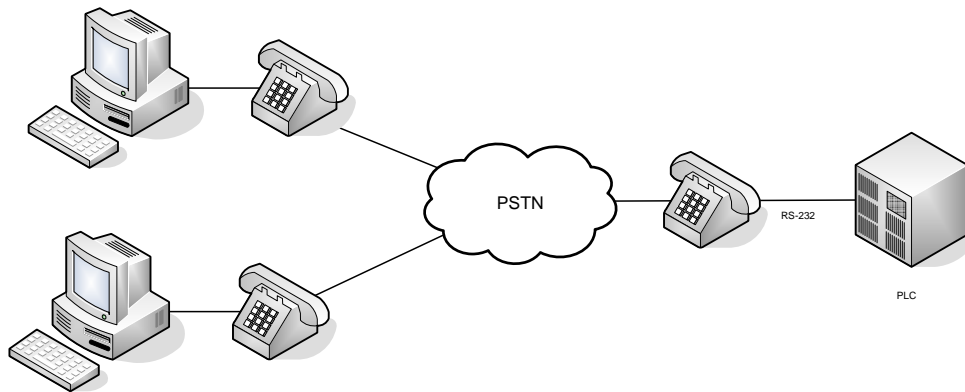

Figure 41.4: Using a serial port redirector software

¹Serial/IP is a registered trademark of Tactical Software LLC.

41.1.1.4 Modem replacement / AT command interpreter

The AT Command mode in Serial Over IP is designed to be used with old legacy serial equipments that historically used PSTN or leased line modems.



Serial Over IP allows serial equipments to use Internet instead.

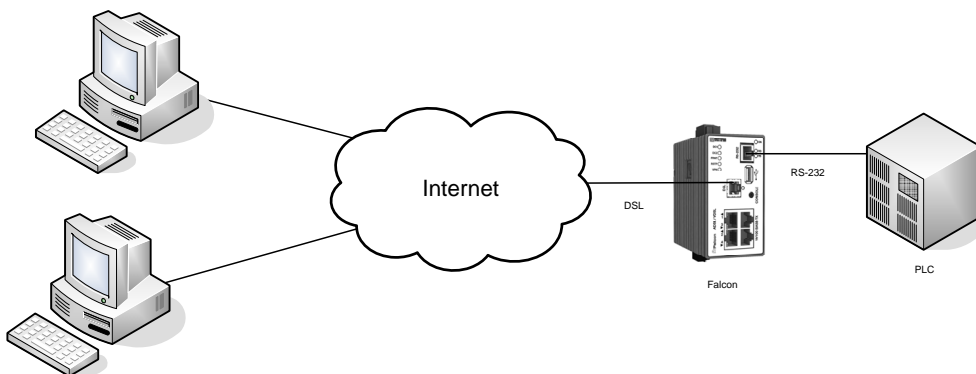

To enable an easy transitions from old modems to new DSL modems, the Serial Over IP can be controlled with AT commands.

```

at
OK
ati4
Westermo Teleindustri AB

OK
at&F1S0=0Q0V1X4B0F1&K0
OK
atd13
CONNECT

OK
ath
OK

NO CARRIER
    
```

Figure 41.5: Terminal connected to a DDW-226

41.1.2 Serial Over IP settings

- *General settings:*

- *Mode:* Set operating mode.

- * *Server:* This is the default setting. In *server* mode, the unit will act as a TCP server, and listen for incoming call establishments. Only a single client can connect to the serial port at time. This mode can be used both in *point-to-point* serial extension ([section 41.1.1.1](#)) and *serial port redirector* ([section 41.1.1.3](#)) applications.
 - * *Client:* In *client* mode, the unit will act as a TCP client, and initiate a connection to a remote TCP server. This mode can be used in the *point-to-point* serial extension application, see [section 41.1.1.1](#).
 - * *Peer:* In *peer* mode, UDP will be used for serial data transportation. This mode can be used both in the *point-to-point* ([section 41.1.1.1](#)) and *one-to-many* ([section 41.1.1.2](#)) serial extension applications.

In the point-to-point case both peers will specify the IP address of the remote peer as the *destination*. For the *one-to-many* case there are many addressing options, see the item on *Addressing information* below.

- * *AT Command*: In *AT Command* mode the connection is controlled by AT commands. It operates both as a TCP server and a TCP client. The connection is established by entering ATD<NUMBER>. The number must be mapped to an IP address. See *Modem replacement* (section 41.1.1.4) for details.
- * *Server-Multipoint*: In this mode the unit acts as a TCP server, and allows for up to 32 TCP clients to connect on the same TCP Port. Traffic from all TCP connections is forwarded onto the serial port. Traffic from the serial port is forwarded onto all TCP connections.

Default: **Server**

- *Protocol Extensions*: Enable protocol extensions, e.g. RFC2217 Telnet extensions[5]. Needed to verify OEM licence of Serial/IP². As of WeOS v4.33.0, there is no other use of this setting, e.g., there is no support for configuring serial port settings (datarate, number of databits, etc.) via telnet extensions. Such support is planned, but not yet implemented.
- *Serial Port*: Select which serial port to use. Default: **Disabled**
- *Data Packing Settings*: (see section 41.1.3 for further explanation)
 - *Frame separator character*: Define frame separator character, if any. Any 8-bit ASCII character, 0-255, can be used. Default: **Disabled**
 - *Maximum Frame Size*: Define maximum frame size in number of bytes. Allowed values are in range 1-1460 (bytes). Default: **1000 (bytes)**
 - *Maximum Frame Delay*: Define maximum frame delay in milliseconds. Allowed values are in range 1-2550 (ms). Default: **20 (milliseconds)**
- *Addressing information*:
 - *Listen*: Define the local interface to accept incoming Serial Over IP traffic, and the (UDP/TCP) port to listen to. This setting is only applicable in *Server*, *Peer* and *AT Command* modes.

The default is to listen to UDP/TCP port 9000, and to accept traffic on any interface. The *Listen* setting can be used to *limit* incoming Se-

²Serial/IP is a registered trademark of Tactical Software LLC.

rial Over IP traffic to a specific interface³, and/or to define a specific (UDP/TCP) port to listen to.

In *Server* and in AT Command modes, the default is to listen to TCP port 9000, and to accept Serial Over IP traffic on any interface. In *Server* mode, an *additional* listening port may be set to allow support for e.g. failover. See setting *Secondary Listen Port* below.

In *Peer* mode, the default is to listen to UDP port 9000, and to accept serial over IP traffic on any interface. IP Unicast, broadcast⁴, and multicast (for defined multicast groups, see below) are accepted in *Peer* mode.

Default: **Interface: "Any"** (incoming traffic accepted via any interface), and **(UDP/TCP) port: 9000**



Note

If two instances of Serial Over IP are configured, they must listen to different UDP/TCP ports.

- *Secondary Listen Port*: Additional local TCP port to listen to. This setting is only applicable in (TCP) *Server* mode.

For more information, see setting *Secondary mode* below.

Default: **Disabled**

- *Secondary Mode*: If an additional local TCP port is set up (see *Secondary Listen Port* above), the concurrent access to the serial port (collision handling) is controlled by altering this option.

Available options are:

- * *Slotted*: Where the access to the serial port is interleaved between the TCP-sessions. When data is received from a TCP-session, the serial port is reserved for the TCP-session for a timeslot with a length of *timeout* ms. Data received during this time period is sent to the TCP-session with the reservation only. If data is received from the secondary TCP-session, the data will be read when the time period has ended.

³For more fine-grained control to limit Serial Over IP traffic, see [section 33.1.2](#) (Packet Filtering) in the Firewall chapter.

⁴Both IP subnet broadcast packets (e.g., 192.168.1.255 on a 192.168.1.0/24 network), and data link IP broadcast (255.255.255.255) are accepted if received on the appropriate interface.

If data is received from the serial port after the timeout and no new data is available from the TCP-sessions, this data will be forwarded to the last TCP-session that was active.

If data is available from both TCP-sessions at exactly the same time, data is first received from the primary session, then the secondary.

- * *Failover*: Where the primary TCP-session has exclusive access to the serial port until disconnected. Secondary TCP-session data will be handled when the primary session has disconnected, i.e., act as *backup*. When the primary TCP-session comes up again, it will get back the exclusive access to the serial port once data is received on the primary TCP-session.

When the secondary TCP-session is in backup state, incoming data on the secondary-TCP session is ignored.

- * *Raw*: In this case, data from both TCP-sessions are directly forwarded onto the serial port without any handling. Data received from the serial port is returned to both TCP-sessions. **Note:** This means that the applications connecting to the TCP ports have to take full responsibility for the concurrent access to the serial port.

Default: **Slotted, timeout 600 ms**

Configuring a secondary (TCP server) listen port in WeOS, corresponds to the *Dual TCP* feature found in Westermo EDW-100 units. The table below translates between WeOS and EDW-100 settings.

WeOS		EDW-100		
Secondary Mode	Timeout	Dual TCP	Dual TCP Priority	Response Timeout
Slotted	50-65535 (ms)	Enabled	Disabled	50-65535 (ms)
Raw	N/A	Enabled	Disabled	0 (ms)
Failover	N/A	Enabled	Enabled	Empty

- *Multicast group*: Multicast group to receive data from. This is only applicable in *Peer* (UDP) mode. IP multicast addresses are in the following range: 224.0.0.0-239.255.255.255.

When configured, the unit will accept packets to the stated multicast address, when received on the interface and (UDP) port declared in the *Listen* setting. Note: the unit will still accept unicast and broadcast

packets as described in the *Listen* item above.

Default: **Disabled**

- *Destination/peer*: IP address and (UDP/TCP) port numbers to relay data to/from. This setting is only applicable in *Client* and *Peer* modes. In *Client* mode, the destination address should be the IP address of the (remote) Server.

In *Peer* mode, it is possible to specify one or more destinations/peers (maximum 32), and the address can be IP unicast, broadcast⁵, or multicast⁶.

Default: **Disabled**

- *Dynamic peer*: *Peer* mode only. When *dynamic peer*⁷ is enabled, data will be sent to the source of the latest incoming data. (Until there is incoming data, the unit will send data to the (first) configured destination/peer.)

Default: **Disabled**

- *DTR Control*: The DTR (Data Terminal Ready) Control setting is only applicable for RS-232 serial ports, and when Serial Over IP is configured in TCP Server or TCP Client mode. With *DTR Control* enabled, the activation of the TCP session is controlled by the status of the DTR control line:
 - *TCP Server*: With Serial Over IP in TCP server mode, the server will await activation of DTR before it accepts remote TCP clients to establish a connection.
 - *TCP Client*: With Serial Over IP in TCP client mode, the client will not make any TCP connection attempts as long as the DTR is inactive.
 - *AT Command*: With Serial Over IP in AT Command mode, an active connection will be closed if the DTR signal is dropped. When establishing connections the DTR signal is ignored.

With DTR Control enabled, both TCP clients and servers will close an established connection if the DTR becomes inactive. Furthermore, with DTR

⁵Sending to the data link IP broadcast (255.255.255.255) will only work if the unit has a default gateway configured (see [section 22.5.2](#)). IP subnet broadcast (e.g., 192.168.1.255) is preferred.

⁶Sending data to a multicast address will only work if the unit has a default gateway configured (see [section 22.5.2](#)).

⁷The "dynamic peer" setting is referred to as "latest calling" in Westermo EDW-100.

Control enabled, data arriving on the serial port will be dropped while DTR is inactive.

Default: **Disabled**

41.1.3 Packing Algorithm

When data arrives at the serial port of the WeOS unit, one of the following criteria must be fulfilled before the serial data is encapsulated into a UDP/TCP packet and sent over the network.

- *Frame separator character detected:* A frame separator character can be defined. The serial data buffered will be sent over the network when this character is detected, e.g., "13" for Carriage return). Any 8-bit ASCII character, 0-255, can be used.
- *Maximum Frame Size Reached:* A maximum frame size must be defined. This is the maximum number of serial data bytes that will be carried in each UDP/TCP frame. When the maximum number of bytes is buffered, the packet will be transmitted over the network. Allowed values are in range 1-1460 (bytes). Values above 255 are approximate.
- *Maximum Frame Delay Reached:* A maximum frame delay can be defined. This is the time, after the last received character in the buffer, the WeOS unit will wait until the buffered serial data is sent over the network. Allowed values are in range 1-2550 ms; If *maximum frame delay* is used with low data rates (see [section 40.1.1](#)), it should be set to at least one "character time".

41.1.4 AT Commands

The AT command interpreter has a limited AT command set. [Table 41.1](#) lists the supported AT commands and their function.

In addition to the AT commands listed in [table 41.1](#), WeOS units accept the set AT commands listed in [table 41.2](#), however, they only respond "OK". Any combination of these commands and '+', '?', '&', '%', or '\ are valid.

If a specific answer is required *user strings* can be defined, see [section 41.1.5](#).

41.1.5 AT Command profile settings

- *Control settings:* The serial command prompt can be set to not echo back

ATD<phone number>	Dials a "phone number"
ATH	Hang-up a connection
ATA	Answer a call
ATO	Go on-line, from on-line command mode
ATE<0 1>	Set Echo on/off
ATQ<0 1>	Set Quiet mode on/off
ATV<0 1>	Set Verbose mode on/off
ATI<x>	Show identification
+++	The escape sequence.
A/	Repeat the last entered command

Table 41.1: Supported AT commands.

ATB	Always responds OK
ATC	"
ATF	"
ATG	"
ATH	"
ATJ	"
ATK	"
ATL	"
ATM	"
ATN	"
ATP	"
ATR	"
ATS	"
ATT	"
ATU	"
ATX	"
ATY	"
ATZ	"

Table 41.2: Set of AT commands where WeOS units respond "OK".

characters (ATE overrides this). The result codes can be set to either numeric verbose (default) mode (ATV overrides this). These settings are stored in the configuration database in contrast to ATE and ATV command which are not stored. The auto-answer function can be set to off (0) or numbers of

RINGS (default 1) before answering the call.

- *Sync connect settings:* If sync connect is enabled the local and remote side will synchronize the connect sequence, and regularly verify the connection. If an established connection can't be verified the connection will be taken down after a time specified by the timeout setting.
- *Message settings:* The OK, CONNECT, DISCONNECT and ERROR message can be customised if desired. Both verbose and numeric value can be changed.
- *Map settings:* To be able to dial, the phone number must be mapped to an IP-address and port. ATD is equivalent with ATD0, mapping number 0 to an IP-address allows for connecting with ATD without number. Up to 250 map entries can be configured.
- *User strings:* If the serial equipment requires a specific answer to an initialisation string, user answer strings can be defined. They will not perform any function except printing out the desired text. The answer can be with line breaks, use backslash ('\') as line break. The answer can be up to 64 characters long including line breaks.

41.2 Managing Serial Over IP via the web interface

The Web interface provides configuration of the Serial Over IP.

41.2.1 Serial Over IP overview

Menu path: Configuration ⇒ Serial ⇒ Serial Over IP

Serial Over IP







Profile ID	Enabled	Serial Port	Mode	Local Interface		
1	✓	1	server	vlan1:9000		
2	✓	2	atcmd	vlan1:9003		

Figure 41.6: Serial Over IP configuration settings overview

Profile ID	A Unique identifier for the Serial Over IP instance. Automatically generated,
Enabled	If disabled, the instance will not be started (i.e the instance will not listen for data nor send data). A green check-mark means the instance is enabled, and a dash means it is disabled.
Serial Port	The serial port to which the Serial Over IP instance is connected.
Mode	The mode (Server (TCP) , Client (TCP) , Peer (UDP) , or AT Command for this Serial Over IP instance.
Local Interface	The interface to accept incoming Serial Over IP traffic, and the TCP/UDP port to listen to. Only applicable in Server , Peer , and AT Command modes.
 Edit	Click this icon to edit a Serial Over IP instance.
 Delete	Click this icon to remove a Serial Over IP instance.
New	Click this button to create a new Serial Over IP instance. You will be presented to a form where you can configure the new instance. One instance can be created for each serial port found on the device.

41.2.2 New Serial Over IP Instance

Menu path: Configuration ⇒ Serial ⇒ Serial Over IP ⇒ **New**

When clicking the **New** button, the edit page will be displayed. For field descriptions, see [section 41.2.3](#) below.

41.2.3 Edit Serial Over IP Settings





Menu path: Configuration ⇒ Serial ⇒ Serial Over IP ⇒ 

Serial over IP 2

Enabled	<input checked="" type="checkbox"/>
Mode	Peer (UDP) ▾
Serial Port	1 ▾

Frame Separator	Disabled ▾	<input type="text" value="256"/>
Frame Size	<input type="text" value="1000"/>	bytes
Frame Delay	<input type="text" value="20"/>	ms

Listen (Local Interface)	vlan1 ▾	Port	<input type="text" value="9000"/>
Multicast Group	<input type="text" value="255.1.2.3"/>		

Dynamic Peer	<input type="checkbox"/>				
Destination / Peer	1	<input type="text" value="192.168.2.100"/>	Port	<input type="text" value="9000"/>	
	2	<input type="text" value="255.1.2.3"/>	Port	<input type="text" value="9000"/>	
	3	<input type="text" value="192.168.2.5"/>	Port	<input type="text" value="9000"/>	 

On this page you can change the settings for Serial Over IP.

If parameter is applicable in a certain mode is denoted with a character according to:

- S - TCP-Server
- C - TCP-Client
- P - Peer (UDP)
- A - AT Command
- M - TCP-Server-Multipoint



Enabled	All	Check the box to enable the Serial Over IP instance, uncheck to disable. If disabled, the instance will not be started.
Mode	All	Set operating mode: Server (TCP), Client (TCP), Peer (UDP), AT Command or Server-Multipoint.
Protocol Extensions	S	Disable or chose appropriate protocol extension.
DTR Control	S,C,A,M	Enable DTR control on the connection.
Purge Buffers	S,C,M	Controls whether or not the serial buffers are purged on connect.
Serial Port	All	Serial port to use.
AT Command Profile	A	Select a command profile for this AT command instance. See Section 41.1.5 for more information.
Frame separator	All	Enable/Disable and define frame separator character if enabled.
Frame size	All	Define maximum frame size in characters.
Frame delay	All	Define maximum frame delay in milliseconds.
Listen (local end)	S, P, M	The interface to accept incoming Serial Over IP traffic, and the TCP/UDP port to listen to. Default Interface: Any. Default port: 9000
Secondary Listen Port	S	Additional local TCP port to listen to. Will listen on the same interface as set in <i>Listen</i> option. Default: Disabled (empty)
Secondary Mode	S	How to handle concurrent access to serial port. See Section 41.1.2 for available modes. Default: Slotted
Secondary Mode Timeout	S	Timeout for <i>Secondary mode</i> slotted. Default: 600 ms
Continued on next page		

Continued from previous page		
Multicast group	P	Multicast address to listen to.
Dynamic peer	P	Enable/disable dynamic peer ¹ .
Destination/peer	C, P	IP address and (UDP/TCP) port for remote peer(s)/ destinations. In Peer Mode, several destination/peer entries can be configured, and the destination address can be unicast, broadcast or multicast. Default port: 9000
Max TCP sessions	M	Max number och TCP sessions, default 16, max 32

41.2.4 AT Command Profiles overview

Menu path: Configuration ⇒ Serial ⇒ Serial Over IP ⇒ AT Command

AT Command Profiles

Instance		
1		
2		

Click on the Edit icon () to edit the settings of a specific profile.







¹The "dynamic peer" setting is referred to as "latest calling" in Westermo EDW-100.

41.2.5 Edit AT Command Profile

Menu path: Configuration ⇒ Serial ⇒ Serial Over IP ⇒ AT Command⇒ 

On this page you can change the settings for an existing profile or when creating a new profile.

AT Command Profile 1

Auto-Answer	<input type="text" value="1"/>		
Echo	<input checked="" type="checkbox"/>		
Verbose	<input checked="" type="checkbox"/>		
Connect Delay	<input type="text" value="0"/> (ms)		
Sync Connect	Enabled <input type="button" value="v"/>	Timeout/Keepalive <input type="text" value="60"/> (s)	
		Max Ring Count <input type="text" value="0"/>	
Phone Number to IP Address Mapping	Number	IP Address	Port
	<input type="text" value="1355"/>	<input type="text" value="192.168.2.225"/>	<input type="text" value="9000"/>  
Result Messages		Verbose	Numeric
	OK	<input type="text" value="OK"/>	<input type="text" value="0"/>
	Error	<input type="text" value="ERROR"/>	<input type="text" value="4"/>
	Connect	<input type="text" value="CONNECT"/>	<input type="text" value="1"/>
	Disconnect	<input type="text" value="NO CARRIER"/>	<input type="text" value="3"/>
User Strings	AT Command	Response	
	<input type="text" value="+MS?"/>	<input type="text" value="+MS: AUTOV8,1,75,33600,75,33600"/>  	
	<input type="text"/>	<input type="text"/>  	

Auto-Answer	Set auto-answer, answer after number of rings. Set this to 0 for no auto-answer. Default: 1 .
Echo	Enables/disables echo (ATE overrides this). Default: enabled
Verbose	Enables/disables verbose result messages (ATV overrides this). Default: enabled
Connect delay	Configures the connection delay. Default: 0 ms
Sync Connect	Enables/disables synchronized connections. Default: disabled
Sync Connect Timeout/Keepalive	Configures the timeout for synchronized connections. Default: 60s
Sync Connect Max Ringcount	Configures the max ring count Default: 0 (disabled)
Mapping	Maps phone number to IP-addresses and ports.
OK-Message	Configure the OK message, verbose text and numeric value. Default-verbose: OK, Default-numeric: 0
Error-Message	Configure the Error message, verbose text and numeric value. Default-verbose: ERROR, default-numeric: 4
Connect-Message	Configure the Connect message, verbose text and numeric value. Default-verbose: CONNECT, Default-numeric: 1
Disconnect-Message	Configure the Disconnect message, verbose text and numeric value. Default-verbose: NO CARRIER, Default-numeric: 3
User strings	Configures user strings and answer. The answer can be up to 64 characters long including line breaks.

41.2.6 Serial Over IP Status

Menu path: Status ⇒ Serial ⇒ Serial Over IP

On this page you can see status for the Serial over IP profiles.

Serial Over IP

Profile ID	Mode	Enabled		Total Bytes	Transfer Rate bytes/s		
					Current	Average	Peek
1	client	✓	TX	4808	124	161	292
			RX	2521	195	122	199
2	atcmd	✓	TX	14561	450	383	8486
			RX	643865	12	1568	5768

Auto refresh: Off, [5s](#), [15s](#), [30s](#), [60s](#)

Refresh

Profile ID	The Serial Over IP profile ID .
Enabled	Indicates if the profile is enabled. A green checkmark means the instance is enabled, and a dash means it is disabled.
Total Bytes	Total number of bytes sent/received (TX/RX) by this profile.
Transfer Rate, Current	Current transfer rate sending/receiving (TX/RX) for this profile.
Transfer Rate, Average	Average transfer rate sending/receiving (TX/RX) for this profile.
Transfer Rate, Peek	Highest transfer rate sending/receiving (TX/RX) for this profile.

41.3 Managing Serial Over IP via the CLI interface

The table below shows Serial Over IP management features available via the CLI.

Command	Default	Section
<u>Configure Serial Over IP settings</u>		
seroip		Section 41.3.1
<u>Settings common to all modes</u>		
[no] mode <server client peer atcmd server-multipoint>	server	Section 41.3.2
[no] port <SERIAL-PORT>	Disabled	Section 41.3.3
[no] frame-separator <0-255>	Disabled	Section 41.3.4
[no] frame-delay <1-2550>	20	Section 41.3.5
[no] frame-size <1-1460>	1000	Section 41.3.6
[no] priority	Normal	Section 41.3.7
<u>Additional Server mode (TCP) settings</u>		
[no] listen <IFACE[:PORT]>	Disabled	Section 41.3.8
[no] protocol <raw telnet>	Disabled	Section 41.3.9
[no] listen-secondary port <PORT>	Disabled	Section 41.3.10
[no] secondary-mode <failover raw slotted <TIMEOUT>>	slotted 600	Section 41.3.11
[no] dtr-control	Disabled	Section 41.3.12
[no] purge-buffers	Disabled	Section 41.3.13
<u>Additional Client mode (TCP) settings</u>		
[no] peer <ADDRESS[:PORT] [,ADDRESS:PORT,...]>	Disabled	Section 41.3.14
[no] dtr-control	Disabled	Section 41.3.12
[no] purge-buffers	Disabled	Section 41.3.13
<u>Additional Peer mode (UDP) settings</u>		
[no] listen <IFACE[:PORT]>	Disabled	Section 41.3.8
[no] peer <ADDRESS[:PORT] [,ADDRESS:PORT,...]>	Disabled	Section 41.3.14
[no] mcast-group <ADDRESS>	Disabled	Section 41.3.15
[no] dynamic-peer	Disabled	Section 41.3.16

Continued on next page

Continued from previous page		
Command	Default	Section
<u>Additional AT Command mode settings</u>		
[no] listen <IFACE[:PORT]>	Disabled	Section 41.3.8
[no] atcmd-set <ID>	Disabled	Section 41.3.17
<u>Additional Server-Multipoint mode settings</u>		
[no] listen <IFACE[:PORT]>	Disabled	Section 41.3.8
[no] dtr-control	Disabled	Section 41.3.12
[no] purge-buffers	Disabled	Section 41.3.13
[no] max-tcp-sessions <1-32>	16	Section 41.3.18
<u>Configure AT Command profiles</u>		
[no] atcmd [ID]	1	Section 41.3.19
[no] auto-answer <COUNT>	1	Section 41.3.20
[no] echo	Enabled	Section 41.3.21
[no] verbose	Enabled	Section 41.3.22
[no] connect-delay <0-1000>	0	Section 41.3.23
[no] sync-connect	Disabled	Section 41.3.24
[no] sync-timeout <10-120>	60	Section 41.3.25
[no] sync-ring-count <0-150>	0	Section 41.3.26
[no] ok-message text <MESSAGE> code <CODE>	OK 0	Section 41.3.27
[no] error-message text <MESSAGE> code <CODE>	ERROR 4	Section 41.3.28
[no] connect-message text <MESSAGE> code <CODE>	CONNECT 1	Section 41.3.29
[no] disconnect-message text <MESSAGE> code <CODE>	NO CARRIER 3	Section 41.3.30
[no] map number <PSTN-NUM> to <ADDRESS[:PORT]>	9000	Section 41.3.31
[no] user-message command <COMMAND> text <MESSAGE>		Section 41.3.32

41.3.1 Managing Serial Over IP settings

Syntax [no] seroip

Context [Global Configuration](#) context

Usage Enter the Serial Over IP Configuration context. A Serial over IP instance will be created, unless it already exists.

Use **"no seroip"** to remove your instance(s).

Use **"show seroip"** (from [Global Configuration](#) context) to list summary information for configured Serial Over IP instance(s), or use **"show seroip [ID]"** to list detailed information on a specific Serial Over IP instance (also available as **"show"** command within the Serial Over IP Configuration context).

Default values Not applicable.

41.3.2 Setting Mode

Syntax [no] mode <server|client|peer|atcmd|server-multipoint>

Context [Serial Over IP Configuration](#) context

Usage Set Serial Over IP mode. For example, use **"mode client"** to set Client mode.

Use **"no mode"** to reset the setting to default. Use **"show mode"** to show the current setting.

Default values Server

41.3.3 Setting Serial Port

Syntax [no] port <SERIAL-PORT>

Context [Serial Over IP Configuration](#) context

Usage Set serial port, e.g., use **"port 1"** to select serial port 1 on a single slot unit, or **"port 1/1"** to select serial port 1 in slot 1 of a slotted WeOS unit.

You can use the **"show serial"** command in Admin Exec (see [section 40.3.11](#)) mode to list information about your serial ports, including the serial port numbers.

Use **"no port"** to deselect the defined serial port.

 **Note**

The Serial Over IP instance will not be activated if no serial port is defined.

Use **"show port"** to show the current setting.

Default values Disabled (**"no port"**)

41.3.4 Setting Frame Separator

Syntax [no] frame-separator <0-255>

Context [Serial Over IP Configuration](#) context

Usage Define frame separator character, if any. Any 8-bit ASCII character, 0-255, can be used.

Use **"no frame-separator"** to disable frame separator checking in the packing algorithm.

Use **"show frame-separator"** to show the current setting.

Default values Disabled (**"no frame-separator"**)

41.3.5 Setting Frame Delay

Syntax [no] frame-delay <1-2550>

Context [Serial Over IP Configuration](#) context

Usage Define maximum frame delay in milliseconds.

Use **"no frame-delay"** to disable maximum delay checking in the packing algorithm.

Use **"show frame-delay"** to show the current setting.

Default values 20 (milliseconds)

41.3.6 Setting Frame Size

Syntax [no] frame-size <1-1460>

Context [Serial Over IP Configuration](#) context

Usage Define maximum frame size in bytes (this is part of the packing algorithm).

Use **"no frame-size"** to reset the maximum frame size to the default value.

Use **"show frame-size"** to show the current setting.

Default values 1000 (bytes)

41.3.7 Enable/disable elevated IP Priority

Syntax [no] priority

Context [Serial Over IP Configuration](#) context

Usage Use **"priority"** to elevate IP priority. Use **"no priority"** to set normal priority.

Use **"show priority"** to show the current setting.

Default values Normal

41.3.8 Setting listen interface and port

Syntax [no] listen <IFACE[:PORT]>

Context [Serial Over IP Configuration](#) context

Usage Set local interface and (UDP/TCP) port to listen to.

Specify an interface to limit incoming traffic to the stated interface, or **"any"** to accept traffic via any interface.

Specify **"PORT"** to configure a specific (TCP/UDP) port to listen to.

Use **"no listen"** to accept traffic for (TCP/UDP) port 9000 on any interface.

Use **"show listen"** to show the current setting.

Default values Any interface, (UDP/TCP) port 9000 (**"no listen"**)

41.3.9 Setting Protocol Extensions

Syntax [no] protocol <raw|telnet>

Context [Serial Over IP Configuration](#) context

Usage Set protocol extensions. This is only applicable in *server* mode ([section 41.3.2](#)).

When accessing the serial port with Westermo's OEM version of Serial/IP^{®8} the protocol extension setting should be "**protocol telnet**".

Use "**no protocol**" (or "**protocol raw**") to disable protocol extensions.

Use "**show protocol**" to show the current setting.

Default values Disabled ("**no protocol**")

41.3.10 Setting secondary listen port

Syntax [no] listen-secondary port <PORT>

Context [Serial Over IP Configuration](#) context

Usage Additional local TCP port to listen to. Will listen on the same interface as set in *Listen* option. Only applicable in TCP-Server mode.

Use "**show listen-secondary**" to show the current setting.

Default values Disabled ("**no listen-secondary**").

41.3.11 Setting secondary mode

Syntax [no] secondary-mode <failover|raw|slotted <TIMEOUT>>

Context [Serial Over IP Configuration](#) context

Usage How to handle concurrent access to serial port. See [Section 41.1.2](#) for available modes. Only applicable in TCP-Server mode.

Use "**show secondary-mode**" to show the current setting.

Default values Slotted, timeout 600 ms ("**no secondary-mode**").

41.3.12 Enable/disable DTR Control

Syntax [no] dtr-control

Context [Serial Over IP Configuration](#) context (Only applicable in TCP Client and TCP Server modes, and only for RS-232 serial ports)

⁸Serial/IP is a registered trademark of Tactical Software LLC.

Usage Use **"dtr-control"** to activate DTR control. With DTR Control enabled, the activation of the TCP session is controlled by the status of the RS-232 DTR control line:

- *TCP Server:* With Serial Over IP in TCP server mode, the server will await activation of DTR before it accepts remote TCP clients to establish a connection.
- *TCP Client:* With Serial Over IP in TCP client mode, the client will not make any TCP connection attempts as long as the DTR is inactive.

With DTR Control enabled, both TCP clients and servers will close an established connection if the DTR becomes inactive.

Use **"no dtr-control"** to disable DTR control.

Use **"show dtr-control"** to show the current setting.

Default values Disabled

41.3.13 Purge Buffers

Syntax [no] purge-buffers

Context [Serial Over IP Configuration](#) context (Only applicable in TCP Client and TCP Server modes)

Usage Controls whether or not the serial buffers are purged on connect.

Use **"show purge-buffers"** to show the current setting.

Default values Disabled

41.3.14 Setting peer address and port

Syntax [no] peer <ADDRESS[:PORT][,ADDRESS:PORT,...]>

Context [Serial Over IP Configuration](#) context

Usage Remote destinations/peer(s) to relay data to/from. Note, this is only used in client or peer mode. If PORT is omitted the default port 9000 will be used.

Use **"show peer"** to show the current setting.

Default values Disabled (**"no peer"**)

41.3.15 Setting multicast group

Syntax [no] mcast-group <ADDRESS>

Context [Serial Over IP Configuration](#) context

Usage Multicast group to listen on. Note, this is only used in peer mode.

Use **"show mcast-group"** to show the current setting.

Default values Disabled (**"no mcast-group"**)

41.3.16 Enabling Dynamic-peer

Syntax [no] dynamic-peer

Context [Serial Over IP Configuration](#) context

Usage Enable/disable dynamic-peer (The "dynamic peer" setting is referred to as "latest calling" in Westermo EDW-100.)

Use **"show dynamic-peer"** to show the current setting.

Default values Disabled

41.3.17 Setting AT Command Set

Syntax [no] atcmd-set <ID>

Context [Serial Over IP Configuration](#) context

Usage Select AT command set. This setting is only valid when Serial Over IP is configured in AT command mode, see [section 41.3.2](#).

Use **"atcmd-set <ID>"** to select an AT command set. AT command sets are created via the **"atcmd <ID>"** command, see [section 41.3.19](#). (The AT command set identifier (ID) can take values in range 1-5.)

Use **"no atcmd-set"** to remove (disable) an AT command set selection.

Use **"show atcmd-set"** to show the current setting.

Default values Disabled (**"no atcmd-set"**)

41.3.18 Max-TCP-Sessions

Syntax [no] max-tcp-sessions <1-32>

Context [Serial Over IP Configuration](#) context (only available when Server-Multipoint mode is selected, see [section 41.3.2](#))

Usage Set the Max number of simultaneous TCP sessions (clients) in Server-Multipoint mode

Use **"no max-tcp-sessions"** to reset to the default setting.

Use **"show max-tcp-sessions"** to show the current setting.

Default values 16

41.3.19 Managing AT Command Profiles

Syntax [no] atcmd [ID]

Context [Global Configuration](#) context

Usage Enter/create the AT Command Profile Configuration context of the given AT Profile instance ID. If this is a new instance, the instance will be created first upon leaving the AT Command profile context with *end* or *leave*.

Use **"no atcmd <ID>"** to remove an existing AT Command profile instance, or **"no atcmd"** to remove all profiles.

Use **"show atcmd"** to show a list of current profiles, or **"show atcmd [ID]"** to show detailed settings for a specific profile (also available as **"show"** command within the AT Command Profile Configuration context).

Default values 1 (i.e., running **"atcmd"** will enter/create AT command set 1. However, running **"no atcmd"** will remove all configured AT command sets.)

41.3.20 Auto-Answer

Syntax [no] auto-answer <COUNT>

Context [AT Command Profile Configuration](#) context

Usage Set auto-answer, answer after number of rings. Use command **"auto-answer 0"** for no auto-answer.

Use command **"no auto-answer"** to reset to the default setting.

Use **"show auto-answer"** to show the current setting.

Default values 1

41.3.21 Echo

Syntax [no] echo

Context [AT Command Profile Configuration](#) context

Usage Enables/disables echo (ATE overrides this)

Use **"show echo"** to show the current setting.

Default values Enabled

41.3.22 Verbose

Syntax [no] verbose

Context [AT Command Profile Configuration](#) context

Usage Enables/disables verbose result messages (ATV overrides this). When disabled only the numeric codes for (the below) messages are displayed.

Use **"show verbose"** to show the current setting.

Default values Enabled

41.3.23 Connect Delay

Syntax [no] connect-delay <0-1000>

Context [AT Command Profile Configuration](#) context

Usage This adds a short delay before switching state to online mode and displaying the connect message.

Use **"show connect-delay"** to show the current setting.

Default values 0 ms

41.3.24 Sync Connection

Syntax [no] sync-connect

Context [AT Command Profile Configuration](#) context

Usage Enables/disables synchronized connections

Use **"show sync-connect"** to show the current setting.

Default values Disabled

41.3.25 Sync Connection Timeout

Syntax [no] sync-timeout <10-120>

Context [AT Command Profile Configuration](#) context

Usage Set the timeout/keepalive for synchronized connections.

Use "**show sync-timeout**" to show the current setting.

Default values 60 s

41.3.26 Sync Ring Count

Syntax [no] sync-ring-count <0-150>

Context [AT Command Profile Configuration](#) context

Usage Set maximum ring count before aborting a connection attempt.

Use "**show sync-timeout**" to show the current setting.

Default values 0 (disabled)

41.3.27 OK-Message

Syntax [no] ok-message text <MESSAGE> [code <CODE>]

Context [AT Command Profile Configuration](#) context

Usage Configure the OK message, verbose mode text and numeric code. Omitting the code will use the default value. If verbose (above) is disabled the numeric code is displayed.

Use "**show ok-message**" to show the current setting.

Default values Text: OK, Code: 10

41.3.28 Error-Message

Syntax [no] error-message text <MESSAGE> [code <CODE>]

Context [AT Command Profile Configuration](#) context

Usage Configure the Error message, verbose mode text and numeric code. Omitting the code will use the default value. If verbose (above) is disabled the numeric code is displayed.

Use **"show error-message"** to show the current setting.

Default values Text: ERROR, Code: 4

41.3.29 Connect-Message

Syntax [no] connect-message text <MESSAGE> [code <CODE>]

Context [AT Command Profile Configuration](#) context

Usage Configure the Connect message, verbose mode text and numeric code. Omitting the code will use the default value. If verbose (above) is disabled the numeric code is displayed.

Use **"show connect-message"** to show the current setting.

Default values Text: CONNECT, Code: 1

41.3.30 Disconnect-Message

Syntax [no] disconnect-message text <MESSAGE> [code <CODE>]

Context [AT Command Profile Configuration](#) context

Usage Configure the Disconnect message, verbose mode text and numeric code. Omitting the code will use the default value. If verbose (above) is disabled the numeric code is displayed.

Use **"show disconnect-message"** to show the current setting.

Default values Text: NO CARRIER, Code: 3

41.3.31 Map

Syntax [no] map number <PSTN-NUMBER> to <ADDRESS[:PORT]>

Context [AT Command Profile Configuration](#) context

Usage Map PSTN number to a remote server IP address.

Use **"show map"** to show the current setting.

Default values 9000 (Default port number is **"9000"**)

41.3.32 User-Message

Syntax [no] user-message command <COMMAND> text <MESSAGE>

Context [AT Command Profile Configuration](#) context

Usage Configures custom user strings and answer. The answer can be up to 64 characters long including line breaks.

Use **"show user-message"** to show the current setting.

Default values Not Applicable.

Chapter 42

Modbus Gateway

This chapter describes the *Modbus Gateway* application available on WeOS products equipped with a serial port. The Modbus Gateway is used for interconnecting a Modbus/TCP network with a Modbus/RTU or a Modbus/ASCII network.

The Modbus Gateway has two operational modes, *server* and *client*:

- *Server*:¹ Allowing one or many Modbus/TCP masters to connect to one or many serial Modbus slaves. In this mode the gateway acts as Modbus/TCP slave on the TCP/IP side and a Modbus Master on the serial side. All incoming Modbus/TCP requests are converted into either Modbus/RTU or Modbus/ASCII requests on the serial side.

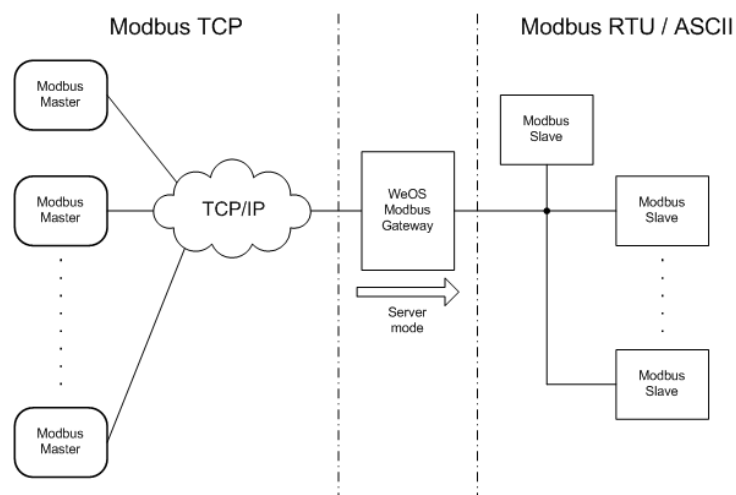

¹In *server* mode, the Modbus Gateway acts as a server on the TCP/IP side (TCP Server).

- *Client*:² Allowing one serial Modbus Master to connect to one or many Modbus/TCP slaves. In this mode the Gateway acts as a Modbus Master on the TCP/IP side and a Modbus Slave on the serial side. All Modbus/RTU requests (or Modbus/ASCII requests) on the serial side are converted into Modbus/TCP requests on the TCP/IP side.

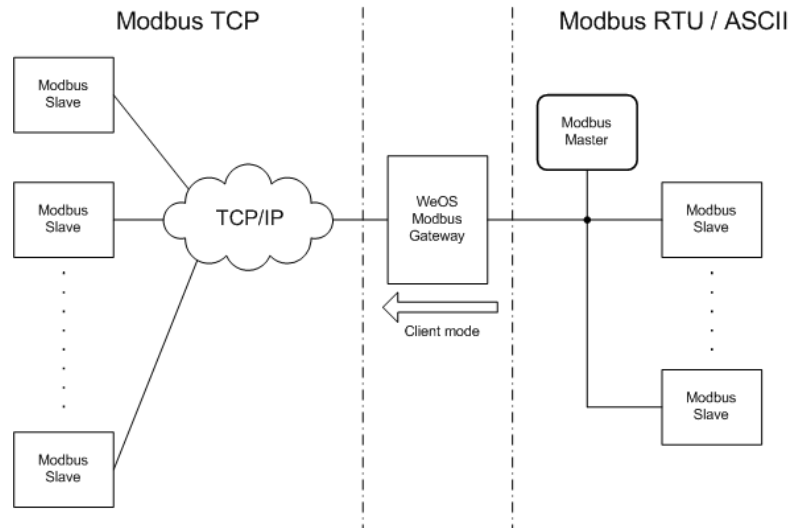

²In *client* mode, the Modbus Gateway acts as a client on the TCP/IP side (TCP Client).

42.1 Managing Modbus Gateway via the web interface

The Web interface provides configuration of all Modbus Gateway Settings.

42.1.1 Modbus Gateway Overview

Menu path: Configuration ⇒ Serial ⇒ Modbus

Click the **New** button to create a Modbus Gateway and you will be presented to the edit page described in [section 42.1.2](#). Otherwise, the Modbus Gateway will be presented in a short overview.

Modbus Gateway

Enabled	Serial Port	Mode	Local Interface	
✓	1	server	vlan1	 

42.1.2 Edit Modbus Gateway Settings

Menu path: Configuration ⇒ Serial ⇒ Modbus ⇒ **New**

Menu path: Configuration ⇒ Serial ⇒ Modbus ⇒ 

Modbus Gateway

Enabled	<input checked="" type="checkbox"/>
Gateway Mode	Server
Serial Port	1
Serial Protocol	RTU
RTU Interval	50 ms
Response Timeout	500 ms
Listen interface	vlan1
Port	502
Request Queue	<input checked="" type="checkbox"/>
Inactivity Timeout	Disabled
Time	60 sec
Poll Interval	50 ms
Broadcast Delay	100 ms
Redirect	Disabled
Addr.	1
Redirect Broadcast	<input type="checkbox"/>
Exceptions	Enabled
Error Check	<input checked="" type="checkbox"/>

Apply Cancel

Configuration of Modbus Gateway in Server Mode

Modbus settings common to Client and Server Modes

Gateway Mode	Configures the Modbus Gateway mode: (TCP) <i>Server</i> or (TCP) <i>Client</i>
Serial Port	Selects the Serial Port
Serial Protocol	Configures Serial protocol (RTU or ASCII)
RTU Interval	Configures the RTU-interval if RTU is selected as serial protocol.
ASCII Timeout	Configures the ASCII timeout if ASCII is selected as serial protocol.
Response Timeout	Configures the Response timeout
Error Check	Enables or disables CRC/LRC error check

Continued on next page

Continued from previous page	
Exceptions	Configures Modbus Exceptions. With Modbus Exceptions enabled, the Modbus Gateway will react upon and respond to certain error conditions, e.g., if a Gateway in <i>client</i> mode receives a (serial) Modbus message addressed to Modbus unit not found in its <i>Map table</i> . If exception handling is desired, except for this particular situation, the gateway can be configured to ignore exceptions for unknown units.

Modbus Server specific settings

Listen interface	Configures the listen Interface and port.
Poll Interval	Configures the Poll Interval
Inactivity Timeout	Configures the Inactivity timer
Broadcast Delay	Configures the Broadcast delay
Redirect	Configures the Modbus Address redirection
Redirect Broadcast	Enables/Disables redirect of Modbus broadcasts
Request Queue	Enables/Disables the Request Queue

Modbus Gateway

Enabled

Gateway Mode Client

Serial Port 1

Serial Protocol RTU

RTU Interval 50 ms

Response Timeout 500 ms

Exceptions Enabled

Error Check

Map table

Mb. Addr.	IP Address	Port	
1	192.168.2.11	502	🗑️
2	192.168.2.12	502	🗑️
3	192.168.2.13	502	🗑️ +

Configuration of Modbus Gateway in Client Mode

Modbus Client specific settings

Map table	Configures the mapping of Modbus unit number to IP address and TCP port number of Modbus/TCP slaves.
------------------	--

42.1.3 Modbus Gateway Status Page

Menu path: Status ⇒ Serial ⇒ Modbus

Modbus Gateway Status

WeOS v9.99 | client@

Instance	Gateway Mode	Serial Port	Serial Protocol	Listen Interface
1	Client	2	ASCII	N/A
2	Server	1	RTU	ANY:555

Active connections

Instance	Remote Ip Address	Modbus Unit Address	Exception	Time Since Event (s)
1	127.0.0.1 : 555	1		3553
2	127.0.0.1 : 44996	1		3553

Auto-Refresh: Off, [5s](#), [15s](#), [30s](#), [60s](#)

Gateway Mode	Current operation mode of the gateway, Server or Client .
Serial Port	The serial port in use.
Serial Protocol	Serial protocol, RTU or ASCII .
Listen Interface	Listen interface and port (only in server mode).
Active connections	This list shows active and open sessions. The gateway can only handle 16 open TCP sessions; if a new connection is needed, the oldest session will be closed.
Auto Refresh	Click on a value to make the page reload with updated statistics automatically every 5, 15, 30 or 60 seconds. Click Off to turn off auto refresh.
Refresh	Click on this button to reload with updated statistics.

42.2 Managing Modbus Gateway via the CLI interface

The table below shows Modbus Gateway management features available via the CLI.

Command	Default	Section
<u>Configure Modbus Gateway settings</u>		
[no] modbus [instance]		Section 42.2.1
[no] enable	Enabled	Section 42.2.2
[no] mode <server client>	server	Section 42.2.3
[no] port <SERIAL-PORT>	Disabled	Section 42.2.4
[no] serial-protocol <rtu ascii>	rtu	Section 42.2.5
[no] listen iface <IFNAME any> [port <PORT>]	Any:502	Section 42.2.6
[no] ascii-timeout <MILLISECONDS>	1000	Section 42.2.7
[no] rtu-interval <MILLISECONDS>	50	Section 42.2.8
[no] poll-interval <MILLISECONDS>	50	Section 42.2.9
[no] error-check	Enabled	Section 42.2.10
[no] inactivity-timeout <SECONDS>	Disabled	Section 42.2.11
[no] response-timeout <MILLISECONDS>	500	Section 42.2.12
[no] broadcast-delay <MILLISECONDS>	100	Section 42.2.13
[no] redirect <MODBUS-ADDR>	Disabled	Section 42.2.14
[no] redirect-broadcast	Disabled	Section 42.2.15
[no] request-queue	Enabled	Section 42.2.16
[no] exceptions [ignore-unknown]	Enabled	Section 42.2.17
[no] map unit <MODBUS-ADDR> address <IPADDRESS>[:<PORT>]	N/A	Section 42.2.18
<u>Show Modbus Gateway Status</u>		
show modbus		Section 42.2.19

42.2.1 Managing Modbus Gateway settings

Syntax [no] modbus [instance]

Context [Global Configuration](#) context

Usage Enter the Modbus Gateway Configuration context. A gateway instance

will be created, unless it already exists. As of WeOS v4.33.0 max two Modbus Gateway instance is supported.

Use **"no modbus [instance]"** to remove your Gateway instance(s).

Use **"show modbus"** (from [Global Configuration](#) context) to list summary information for configured Modbus Gateway instance(s). Use **"show"** (within the Modbus Gateway Configuration context) to list detailed information on a specific Modbus Gateway instance.

Default values Not applicable.

42.2.2 Setting Enable

Syntax [no] enable

Context [Modbus Gateway Configuration](#) context

Usage Use **"enable"** to enable and **"no enable"** to disable a Modbus Gateway instance. (Other gateway settings are preserved.)

Use **"show enable"** to show whether this gateway instance is enabled or disabled.

Default values Enabled

42.2.3 Setting Mode (Client or Server)

Syntax [no] mode <server|client>

Context [Modbus Gateway Configuration](#) context

Usage Use **"mode server"** or **"mode client"** to configure the Modbus Gateway in *server* and *client* mode respectively.

Use **"no mode"** to reset the mode to default (server).

Use **"show mode"** to show the Modbus Gateway mode setting.

Default values Server (**"mode server"**)

42.2.4 Setting Serial Port

Syntax [no] port <SERIAL-PORT>

Context [Modbus Gateway Configuration](#) context

Usage Set serial port, e.g., use **"port 1"** to select serial port 1 on a single slot unit, or **"port 1/1"** to select serial port 1 in slot 1 of a slotted WeOS unit.

You can use the **"show serial"** command in Admin Exec (see [section 40.3.11](#)) mode to list information about your serial ports, including the serial port numbers.

Use **"no port"** to deselect the defined serial port.

 **Note**

| The Modbus Gateway will not be activated if no serial port is defined.

Use **"show port"** to show the Modbus Gateway port setting.

Default values Disabled (**"no port"**)

42.2.5 Setting Serial Protocol

Syntax [no] serial-protocol <rtu|ascii>

Context [Modbus Gateway Configuration](#) context

Usage Use **"serial-protocol rtu"** or **"serial-protocol ascii"** to specify use of RTU or ASCII as serial protocol respectively.

Use **"no serial-protocol"** to reset the serial protocol to default (RTU).

Use **"show serial-protocol"** to show the serial protocol setting.

Default values RTU (**"serial-protocol rtu"**)

42.2.6 Setting listen interface and port

Syntax [no] listen iface <IFNAME|any> [port <PORT>]

Context [Modbus Gateway Configuration](#) context (*server* mode only)

Usage Setting local interface and TCP port to listen to.

Acceptable port range is in range <1-65335> (default port 502). Omitting the **"port"** argument leaves the port number unchanged.

Use **"no listen"** to reset the setting to default (listen on any interface, port 502)

Use **"show listen"** to show the current listen setting.

The setting is only applicable when configuring the Modbus Gateway in "server" mode (see [section 42.2.3](#)).

Default values Any interface, port 502 ("listen iface any port 502")

42.2.7 Setting ASCII Timeout

Syntax [no] ascii-timeout <MILLISECONDS>

Context [Modbus Gateway Configuration](#) context

Usage Set ASCII Timeout, i.e., the maximum time between two frames in ASCII mode. Allowed range is <10-7050> (milliseconds).

Use "no ascii-timeout" to reset the timeout to the default value (1000 milliseconds).

Use "show ascii-timeout" to show the current timeout setting.

The "ascii-timeout" command is only applicable when configuring the Modbus Gateway to use "ascii" as serial protocol (see [section 42.2.5](#)).

Default values 1000

42.2.8 Setting RTU Interval

Syntax [no] rtu-interval <MILLISECONDS>

Context [Modbus Gateway Configuration](#) context

Usage Set RTU Interval, i.e., the minimum time between two frames in RTU mode. Allowed range is <10-7050> (milliseconds).

Use "no rtu-interval" to reset the interval to the default value (50 milliseconds).

Use "show rtu-interval" to show the current interval setting.

The "rtu-interval" command is only applicable when configuring the Modbus Gateway to use "rtu" as serial protocol (see [section 42.2.5](#)).

Default values 50

42.2.9 Setting Poll Interval

Syntax [no] poll-interval <MILLISECONDS>

Context [Modbus Gateway Configuration](#) context (*server* mode only)

Usage Set Poll Interval. Allowed values are in range <10-65535> (milliseconds).

Use **"no poll-interval"** to reset the interval to the default value (50 milliseconds).

Use **"show poll-interval"** to show the current interval setting.

Only applicable when configuring the Modbus Gateway in **"server"** mode (see [section 42.2.3](#)).

Default values 50

42.2.10 Setting Serial Error Check

Syntax [no] error-check

Context [Modbus Gateway Configuration](#) context

Usage Use **"error-check"** to enable and **"no error-check"** to disable serial error check.

Use **"show error-check"** to show the current error check setting.

Default values Enabled

42.2.11 Setting Inactivity Timeout

Syntax [no] inactivity-timeout <SECONDS>

Context [Modbus Gateway Configuration](#) context (*server* mode only)

Usage Set Inactivity Timeout, i.e., the time to keep an idle session open. Allowed values are in range <10-65535> (seconds).

Use **"no inactivity-timeout"** to disable the inactivity timeout.

Use **"show inactivity-timeout"** to show the current timeout setting.

Only applicable when configuring the Modbus Gateway in **"server"** mode (see [section 42.2.3](#)).

Default values Disabled

42.2.12 Setting Response Timeout

Syntax [no] response-timeout <MILLISECONDS>

Context [Modbus Gateway Configuration](#) context

Usage Set Response Timeout. Allowed values are in range <1-65535> (milliseconds).

Use **"no response-timeout"** to reset the response timeout to default (500 milliseconds).

Use **"show response-timeout"** to show the current timeout setting.

Default values 500

42.2.13 Setting Broadcast Delay

Syntax [no] broadcast-delay <MILLISECONDS>

Context [Modbus Gateway Configuration](#) context (*server* mode only)

Usage Set Broadcast Delay, i.e., time to wait after transmitting an broadcast. Allowed values are in range <0-65535> (milliseconds).

Use **"no broadcast-delay"** to reset the broadcast delay to default (100 milliseconds).

Use **"show broadcast-delay"** to show the current delay setting.

Only applicable when configuring the Modbus Gateway in **"server"** mode (see [section 42.2.3](#)).

Default values 100

42.2.14 Setting Redirect

Syntax [no] redirect <MODBUS-ADDR>

Context [Modbus Gateway Configuration](#) context (*server* mode only)

Usage Set redirect, i.e., redirect all Modbus addresses to this address. Allowed values are in range <1-255> (seconds)

Use **"no redirect"** to disable the redirect setting.

Use **"show redirect"** to show the current redirect setting.

Only applicable when configuring the Modbus Gateway in **"server"** mode (see [section 42.2.3](#)).

Default values Disabled

42.2.15 Setting Redirect Broadcast

Syntax [no] redirect-broadcast (*server* mode only)

Context [Modbus Gateway Configuration](#) context

Usage Set redirect broadcast, i.e., redirect all Modbus broadcasts to Modbus address 1.

Use **"no redirect-broadcast"** to disable the redirect broadcast setting.

Use **"show redirect-broadcast"** to show the current redirect broadcast setting.

Only applicable when configuring the Modbus Gateway in **"server"** mode (see [section 42.2.3](#)).

Default values Disabled

42.2.16 Setting Request Queue

Syntax [no] request-queue

Context [Modbus Gateway Configuration](#) context (*server* mode only)

Usage Enabled/disables Request Queue.

Use **"request-queue"** to enable and **"no request-queue"** to disable the request queue.

Use **"show request-queue"** to show the current setting.

Only applicable when configuring the Modbus Gateway in **"server"** mode (see [section 42.2.3](#)).

Default values Enabled

42.2.17 Setting Exceptions

Syntax [no] exceptions [ignore-unknown]

Context [Modbus Gateway Configuration](#) context

Usage Enable/disables handling of Modbus exceptions. With Modbus Exceptions enabled, the Modbus Gateway will react upon and respond to certain error conditions, e.g., if a Gateway in *client* mode receives a (serial) Modbus message addressed to Modbus unit not found in its *Map table*. If exception handling is desired, except for this particular situation, the gateway can be configured to ignore exceptions for unknown units ("**exceptions ignore-unknown**").

Use "**no exceptions**" to disable exception handling.

Use "**show exceptions**" to show the current exception setting.

Default values Enabled (all exceptions enabled)

42.2.18 Managing Mapping of Modbus units to IP hosts

Syntax [no] map unit <MODBUS-ADDR> address <ADDRESS>[:<PORT>]

Context [Modbus Gateway Configuration](#) context (*client* mode only)

Usage Setup Modbus IP map.

Use e.g., "**map unit 33 address 192.168.5.11**" to map Modbus unit 33 to IP host 192.168.5.11 and (default) port 502.

Use "**no map**" to remove all mappings, or "**no map unit <MODBUS-ADDR>**" to remove an individual mapping.

Use "**show map**" to show the current mappings.

Only applicable when configuring the Modbus Gateway in "**client**" mode (see [section 42.2.3](#)).

Default values N/A

42.2.19 Show Modbus Gateway status

Syntax show modbus

Context [Admin Exec](#) context.

Usage Show Modbus Gateway status information

Default values Not applicable.

Example

Example

```
example:/#> show modbus
Modbus Gateway Enabled : Yes, running as PID 13046
=1=====
Mode                   : server
Serial port           : 1
Serial protocol       : ascii
Listen                : lo port 555

Remote IP addr        Modbus Addr    Exception
-----
=2=====
Mode                   : client
Serial port           : 2
Serial protocol       : rtu

Remote IP addr        Modbus Addr    Exception
-----
example:/#>
```

Chapter 43

MicroLok II Gateway

This chapter describes the MicroLok II^{®1} Gateway application available on WeOS products equipped with a serial port. The MicroLok Gateway is used for interconnecting MicroLok (serial) networks over an IP network. It provides a MicroLok address lookup table, which defines MicroLok stations on the local serial ports and at remote gateways. Established sessions are supervised, and an alarm indication can be given whenever one or more of these sessions are down.

The MicroLok Gateway support in WeOS is limited to handling MicroLok v2[3].

43.1 Overview of MicroLok Gateway Properties and Management Features

Feature	Web	CLI	General Description
Enable/disable MicroLok Gateway	X	X	
Set Gateway Listen Interface/UDP-port	X	X	Sec. 43.1.1.1
Set Key-On/Key-Off/Grant Delay	X	X	Sec. 43.1.1.1
Manage MicroLok Address Lookup Table	X	X	Sec. 43.1.1.2
View MicroLok Status	X	X	Sec. 43.1.2
MicroLok Packet Monitoring	X		
Manage MicroLok Alarm	X	X	Chapter 25
Manage Serial Port Settings	X	X	Chapter 40

¹MicroLok is a registered trademark of Ansaldo STS USA.

43.1.1 Introduction to MicroLok and the WeOS MicroLok Gateway

The MicroLok II Peer Protocol[3] provides a service where multiple communication sessions between MicroLok Stations can be multiplexed over serial lines. The WeOS MicroLok Gateway can be used to extend the MicroLok network over an IP network, by encapsulating the data packets from the serial side into IP/UDP packets. The packets will be received by a remote MicroLok Gateway, which will decapsulate the IP/UDP packets before forwarding them on its serial side.

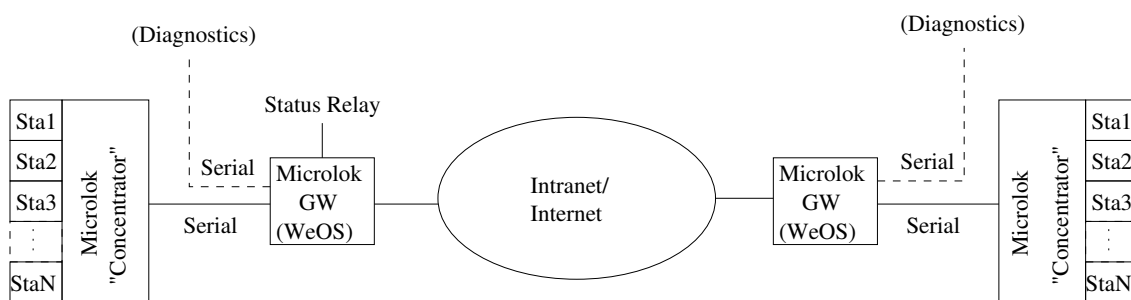

Figure 43.1: Use of MicroLok Gateways to extend a MicroLok network.

MicroLok Diagnostic data is assumed to use the WeOS Serial Over IP service (see [chapter 41](#)) on a different serial port or a different WeOS unit, and is not covered by the MicroLok Gateway functionality specified here. (The dashed lines in [Fig. 43.1](#) illustrate the use of a separate serial port for diagnostic data.)

The WeOS MicroLok gateway listens for MicroLok packets on its serial interface, and forwards them as IP/UDP packets to a remote MicroLok Gateway if a match is found in its MicroLok address lookup table. Similarly, the gateway listens for MicroLok IP/UDP packets, and forwards them on its serial port. General MicroLok settings for IP interface and UDP port, etc., are described further in [section 43.1.1.1](#).

The example topology in [fig. 43.1](#) can be extended to use more than two MicroLok gateways. WeOS units with more than one serial port are able to connect local MicroLok stations on all its serial ports. Further information on connecting local and remote MicroLok stations is given in [section 43.1.1.2](#) when describing the address lookup table.

The MicroLok gateway will monitor established sessions, and is able to signal an alarm if one or more sessions are determined down, see [section 43.1.2](#).

43.1.1.1 General MicroLok Gateway Parameters

As of WeOS v4.33.0 a single MicroLok gateway instance is supported. You can specify which network interface, and which UDP port the gateway should listen on. By default, the gateway will listen for IP/UDP MicroLok packets on *any* network interface and UDP port 60000.

Firewall rules will be added automatically for the specified interface and UDP port. These rules will accept IP/UDP MicroLok packets *coming in on the specified listening interface* and destined for the given UDP port. This automatic firewall rule will suffice in most use cases (if further firewall tweaking is needed, see [chapter 33](#)).

The general MicroLok settings also includes a set of MicroLok specific timeouts applying to MicroLok communication on all local serial ports: *Key-On delay*, *Key-Off delay* and *Grant delay*. These timeouts are all disabled by default, which should be fine in most use cases.

43.1.1.2 The MicroLok Address Lookup Table

The MicroLok Gateway contains an address lookup table. As of WeOS v4.33.0 the table can hold up to 64 address entries, and each entry contains the following items:

- MicroLok Station Address: A two-byte MicroLok address, given as a hexadecimal number, e.g., "**001f**".
- A local or remote destination: The location of the given MicroLok station address is either specified as a local serial port, e.g., "**serial 1**", or as a remote gateway (IP address and optionally a UDP port number), e.g., "**remote 192.168.2.1:12345**" for a remote gateway with IP address 192.168.2.1 listening on UDP port 12345. Either a local serial port or a remote gateway needs to be specified for an address entry to be active.

When remote gateway is specified, the default UDP port number is 60000.

- Station Description: An optional 15 byte text string to describe the given MicroLok station. Disabled by default.
- Session Timeout: Timeout used to determine if a session established with this MicroLok station is down. The session timeout can be in range 500-600000 (milliseconds). Disabled by default.

The MicroLok Gateway can be configured to give an alarm if one or more of the established sessions are down, see [section 43.1.2](#).

**Note**

Serial port settings (rate, start bits, stop bits, parity, etc.) are configured in the general serial port context, see [sections 40.2](#) (Web) and [40.3](#) (CLI). Note that MicroLok stations typically operate with speeds in range 300-38400 bits/s, while serial ports on WeOS units default to rate 115200 bit/s, and should therefore be changed.

43.1.2 MicroLok Session Status and Alarm Handling

The MicroLok Gateway monitors the sessions passing through it. It is possible to view the list of MicroLok sessions and their status ([section 43.2.3](#) for Web and [section 43.3.9](#) for CLI), i.e., you can list which sessions that are UP, which are DOWN, and which are in INIT state:

- Status UP: A session is considered UP when there is *two-way* communication between the two stations, and where data or control traffic is exchanged within the given session timeout between these stations.
- Status DOWN: For a session to be listed as DOWN, it must first have been established, i.e., the session must first have got status UP. If no data or control traffic for the session is detected within the given session timeout it is considered DOWN.
- Status INIT: Sessions where traffic has only been seen in one direction (only from station A to station B, or vice versa) are listed in state INIT. Such sessions are neither considered UP nor DOWN, and are not part of the list of *current MicroLok sessions*. No alarm is indicated for sessions in INIT state.

When the MicroLok gateway service starts, the list of *current sessions* is empty. (The same is true if a MicroLok Gateway configuration change occurs, as this implies a restart of the gateway process.) As new sessions are established (i.e., get status UP) the list of *current MicroLok sessions* grows. As of WeOS v4.33.0, up to 64 MicroLok sessions are supported. When one or more of the sessions in the current list is determined DOWN, a MicroLok alarm will be raised. The alarm will indicate failure state until all sessions in the current list have got status UP. To use this MicroLok summary alarm function, you need to create a *MicroLok alarm trigger*, and map this trigger to a suitable *alarm action*. Thereby you can use, e.g., status relay (digital out) to indicate if there is a problem with any of the MicroLok sessions, as hinted in [fig. 43.1](#). For more information on how to set up MicroLok alarm triggers and alarm actions, see [chapter 25](#). A brief CLI example is given in [section 25.3.2.14](#).

43.2 Managing MicroLok Gateway via the web interface

The Web interface provides configuration of all MicroLok Gateway Settings.

43.2.1 MicroLok Gateway Overview

Menu path: Configuration ⇒ Serial ⇒ MicroLok

If no MicroLok Gateway is configured, the page below will be displayed. Click the **New** button to create a MicroLok Gateway and you will be presented to the edit page described in [section 43.2.2](#).

MicroLok II Gateway

No MicroLok II Gateway configured

New

If a MicroLok Gateway is configured, the short overview page below will be displayed.

MicroLok II Gateway

Enabled	Listen Interface	UDP Listen Port	Serial Port(s)		
	ANY	60000	1		

43.2.2 Edit MicroLok Gateway Settings





Menu path: Configuration ⇒ Serial ⇒ MicroLok ⇒ **New**, or

Menu path: Configuration ⇒ Serial ⇒ MicroLok ⇒ 

Edit MicroLok II Gateway

Enabled	<input checked="" type="checkbox"/>
Listen Interface	ANY
UDP Listen Port	60000
Key On Delay	0 ms
Key Off Delay	0 ms
Grant Delay	0 ms

Address Lookup Table

Address (Hex)	Description	Serial Port	Remote Gateway		Session Timeout	
			IP-Address	UDP Port		
000A		None	192.168.2.201	60000	4000 ms	
0014		1		60000	4000 ms	
		None		60000	ms	 

MicroLok gateway settings

Enable	Enable or disable MicroLok II gateway instance
Listen Interface	Setting listen interface address.
UDP Listen Port	Setting UDP listen port. Acceptable port range is in range <0-65335>, where "port 0" results in using the default port number (60000).
Key On Delay	Set Key-On signal delay in milliseconds, i.e. key-on-delay 100. To disable this function set value to 0 (zero). Allowed range is <1-1000> (milliseconds).
Key Off Delay	Set Key-Off signal delay in milliseconds, i.e. key-off-delay 100. To disable this function set value to 0 (zero). Allowed range is <1-1000> (milliseconds).
Grant Delay	Set Grant signal delay in milliseconds, i.e. grant-delay 100. To disable this function set value to 0 (zero). Allowed range is <500-600000> (milliseconds).

MicroLok gateway address table settings

Address	Setting for the MicroLok address.
Description	Description of the MicroLok address table setting.
Serial Port	Setting for the local serial port.
Remote Gateway	Setting for the remote MicroLok peer address.
Session Timeout	Setting for the session timeout (will be rounded to nearest 100 ms).

43.2.3 MicroLok Gateway Status Page

Menu path: Status ⇒ Serial ⇒ MicroLok (no active sessions)

Microlok II Gateway Status

Listen Interface	ANY
UDP Listen Port	60000

Sessions

Local Address	Remote Address	Remote Peer	Serial Port	State
No sessions				

Auto-Refresh: Off, [5s](#), [15s](#), [30s](#), [60s](#)

Refresh

Menu path: Status ⇒ Serial ⇒ MicroLok (active sessions)

MicroLok II Gateway Status

Listen Interface	ANY
UDP Listen Port	60000

Sessions

Local Address	Remote Address	Remote Peer	Serial Port	State
0x00A1	0x00B1	192.168.55.2 : 60000	2	UP

Auto-Refresh: Off, [5s](#), [15s](#), [30s](#), [60s](#)

Refresh

Listen Interface	Listen interface.
UDP Listen Port	Listen port.

43.3 Managing MicroLok Gateway via the CLI interface

The table below shows MicroLok Gateway management features available via the CLI.

Command	Default	Section
<u>Configure MicroLok Gateway settings</u>		
[no] microlok		Section 43.3.1
[no] enable	Enabled	Section 43.3.2
[no] listen <any IFNAME>[:PORT]	any:60000	Section 43.3.3
[no] key-on-delay <MSEC>	Disabled	Section 43.3.4
[no] key-off-delay <MSEC>	Disabled	Section 43.3.5
[no] grant-delay <MSEC>	Disabled	Section 43.3.6
[no] map station [dec] <MICROLOK-ADDR> <remote <IPADDRESS>[:<PORT>] <serial <SERIALPORT>>		Section 43.3.7
[session-timeout <MSEC>]		
[description <STRING>]		
<u>MicroLok Gateway Status and Packet Monitoring</u>		
show microlok		Section 43.3.9
microlok		Section 43.3.10
[no] monitor		Section 43.3.11

43.3.1 Managing MicroLok Gateway settings

Syntax no microlok

Context [Global Configuration](#) context

Usage Enter the Microlok Gateway Configuration context. A gateway instance will be created, unless it already exists. As of WeOS v4.33.0 a single MicroLok Gateway instance is supported.

Use **"no microlok"** to remove your Gateway instance(s).

Use **"show microlok"** (from [Global Configuration](#) context) to list summary

information for configured MicroLok gateway instances. Use **"show"** (within the Microlok Gateway Configuration context) to list detailed information on a specific MicroLok gateway instance.

Default values Not applicable.

 **Example**

```
example:/config/#> show microlok
Microlok II Gateway
ID  Enabled   Serial      Listen Port
-----
1   Enabled   1           60000
example:/config/#> microlok
example:/config/microlok-1/#> show
Microlok II gateway
Status           : Enabled
Listen           : ANY port 60000
Key On Delay     : Disabled
Key Off Delay    : Disabled
Grant Delay      : Disabled

Address Lookup Table (ALT):
-----
Addr  Remote Peer      Serial  Description      Session Timeout (ms)
0010  N/A               1       siteA-ctrl3      Disabled
0020  192.168.3.3:60000 N/A     siteB-ctrl1      Disabled

example:/config/microlok-1/#>
```

43.3.2 Setting Enable

Syntax [no] enable

Context [Microlok Gateway Configuration](#) context

Usage Use **"enable"** to enable and **"no enable"** to disable a MicroLok II gateway instance.

Use **"show enable"** to show whether this gateway instance is enabled or disabled.

Default values Enabled

43.3.3 Setting listen interface and port

Syntax [no] listen <any|IFNAME>[:PORT]

Context [Microlok Gateway Configuration](#) context

Usage Setting local interface and UDP port to listen to, e.g., "**listen vlan1:45678**" to listen on interface *vlan1* and UDP port *45678*. Keyword "**any**" can be used to listen on all interfaces.

Acceptable port range is <1-65335>, where default port number is 60000.

Use "**no listen**" to reset to default settings (listen on any interface, UDP port 60000).

Use "**show listen**" to list the current setting.

Default values Any interface, UDP port 60000.

43.3.4 Setting key-on-delay

Syntax [no] key-on-delay <MILLISECONDS>

Context [Microlok Gateway Configuration](#) context

Usage Set Key-On signal delay in milliseconds, e.g., "**key-on-delay 100**". Allowed range is <1-1000> (milliseconds). Use "**no key-on-delay**" or "**key-on-delay 0**" to disable this function.

Use "**show key-on-delay**" to list the current Key-On signal delay setting.

Default values Disabled (0)

43.3.5 Setting key-off-delay

Syntax [no] key-off-delay <MILLISECONDS>

Context [Microlok Gateway Configuration](#) context

Usage Set Key-Off signal delay in milliseconds, e.g. key-off-delay 100. Allowed range is <1-1000> (milliseconds). Use "**no key-off-delay**" or "**key-off-delay 0**" to disable this function.

Use "**show key-off-delay**" to list the current Key-Off signal delay setting.

Default values Disabled (0)

43.3.6 Setting grant-delay

Syntax [no] grant-delay <MILLISECONDS>

Context [Microlok Gateway Configuration](#) context

Usage Set Grant signal delay in milliseconds, e.g. **"grant-delay 100"**. Allowed range is <1-1000> (milliseconds). Use **"no grant-delay"** or **"grant-delay 0"** to disable this function.

Use **"show grant-delay"** to list the current Grant signal delay setting.

Default values Disabled (0)

43.3.7 Managing Mapping of MicroLok units to IP hosts

Syntax [no] map station [dec] <MICROLOK-ADDR> <serial <SERIALPORT> | remote <IPADDRESS[:UDPPORT]>> [session-timeout <ms>] [description <STRING>]

Context [Microlok Gateway Configuration](#) context

Usage Configure the MicroLok address lookup table entries. Up to 64 MicroLok station entries can be added.

- **MicroLok addresses:** MicroLok addresses are given in hexadecimal form (range: 0-ffff), e.g., **"map station ff serial 1"** or **"map station 0xff serial 1"**. Add the keyword **"dec"** to interpret an address as decimal, e.g., **"map station dec 30 serial 1"** is equivalent to **"map station 1e serial 1"**.
- **Local or Remote Station:** An address entry is only active if a (local) serial port or a (remote) gateway IP address is set:
 - For local MicroLok addresses the serial port is set, e.g., **"map station 10 serial 1"**
 - For remote MicroLok addresses the remote gateway IP address (and optionally the UDP port) is set, e.g., **"map station 20 remote 192.168.3.1:34567"**. Default UDP port is 60000.
- **Session Timeout:** The session timeout will be rounded to nearest 100 ms. Valid range: 500-600000 (ms). Default: Disabled.
- **Description:** The optional description string (15 characters) can be used to provide information on the MicroLok station. Default: Disabled

Use **"no map station MICROLOK-ADDRESS"** (e.g., **"no map station 10"**) to remove a specific station entry, and **"no map"** to remove all station entries from the MicroLok address lookup table.

Default values For remote MicroLok stations, default UDP port is 60000.

43.3.8 Show MicroLok Gateway Setting

Syntax show

Context [Microlok Gateway Configuration](#) context

Usage Show MicroLok Gateway Setting

Default value Not applicable.

43.3.9 Show MicroLok Gateway status

Syntax show microlok

Context [Admin Exec](#) context.

Usage Show MicroLok Gateway status information (also available as **"show"** command within the [Microlok Gateway Status](#) context).

Default values Not applicable.

 **Example**

```
example:/#> show microlok
Microlok II Gateway Enabled : Yes, running as PID 615
Listen Interface           : ANY
UDP Listen Port            : 60000
```

Local Station	Serial	Remote Station	Gateway	State
0014	1	000A	192.168.2.204:60000	UP

43.3.10 Enter MicroLok Gateway Status Context

Syntax microlok

Context [Admin Exec](#) context.

Usage Enter Microlok Gateway Status context. From this context, you can show MicroLok Gateway status (**"show"**, see also [section 43.3.9](#)) and enable/disable MicroLok packet monitoring (see [section 43.3.11](#)).

Default values Not applicable.

43.3.11 Enable MicroLok Packet Monitoring

Syntax [no] monitor

Context [Microlok Gateway Status](#) context.

Usage MicroLok packets being exchanged can be displayed on the WeOS console. Use **"monitor"** to enable monitoring of MicroLok packets, and **"no monitor"** to disable it.

Enabling MicroLok packet monitoring is a debugging facility, not a configuration setting.

Default values Not applicable.

Example

```
example:/#> microlok
example:/microlok#> monitor
Enabling Microlok II Gateway monitor.
example:/microlok#>

### WeOS Microlok II monitor
MSG Status: RCV (00a4) DEST ADDR: 000a SRC ADDR: 0014
MSG TYPE: 01 SNDMSN: 00 RCVMSN: 00 07//06//34 18:54:82
f4 00 0a 00 14 00 00 01 00 a4 07 06 22 12 36 52 1b 00 01 30 38 2e 35 30
00 38 30 2f d6 2f a2 3e 92 94 7d 01 01 01 08 01 01 01 08 01 c5 43 be 2c
f6

### WeOS Microlok II monitor
MSG Status: XMT (0021) DEST ADDR: 0014 SRC ADDR: 000a
MSG TYPE: 06 SNDMSN: 36 RCVMSN: 7e 07//06//34 18:54:82
f4 00 14 00 0a 36 7e 06 00 21 07 06 22 12 36 52 b4 0f 20 66 f6

### WeOS Microlok II monitor
MSG Status: RCV (0021) DEST ADDR: 000a SRC ADDR: 0014
MSG TYPE: 06 SNDMSN: 7e RCVMSN: 36 07//06//34 18:54:82
f4 00 0a 00 14 7e 36 06 00 21 07 06 22 12 36 52 1e 11 3e 48 f6

example:/#>
example:/#> no monitor
Disabling Microlok II Gateway monitor.
```

Part VI

Train Specific Protocols

Chapter 44

TTDP

This chapter describes WeOS support for the Train Topology Discovery Protocol (TTDP)[17], which is part of the IEC 61375 series of protocols.

In short, TTDP dynamically discovers the backbone routers (ETBNs) and *consist networks* (ECNs) in the train, and the way that they are connected. Furthermore, TTDP assigns IP addresses to the ETBNs and ECNs, and establishes routing and NAT entries in ETBNs based on these IP assignments. TTDP is designed to accomplish this as a distributed protocol running on the ETBNs.

The TTDP support in WeOS is limited to RFR-212-FB products[60].

44.1 Overview of TTDP Management Features

Table 44.1 provides a summary of available TTDP features in WeOS. Further descriptions of the train topology discovery protocol and the available features are provided in sections 44.1.1-44.1.3.

44.1.1 TTDP Introduction

TTDP is defined in IEC 61375-2-5[17]. TTDP is managing train backbone *inauguration* (ETB inauguration) in train networks adopting the IEC 61375 train topology model. TTDP is a distributed protocol running on the train router nodes, here referred to as ETB nodes or simply ETBNs. The TTDP protocol provides a wide range of services:

Feature	Web	CLI	General Description
Backbone ID		X	Sections 44.1.2.1, 44.1.3.4
ETBN/Consist Direction		X	Sections 44.1.2.2, 44.1.3.4
Consist UUID		X	Sections 44.1.1, 44.1.2.2, 44.1.3.4
Consist Network		X	Sections 44.1.2.2, 44.1.3.4
Consist network configuration		X	Section 44.1.3.4
Local-ID		X	Section 44.1.3.4
Inauguration inhibition			Sections 44.1.1, 44.1.3.7
TTDP MIB (status)			Section 6.1.5.1

Table 44.1: Summary of TTDP features.

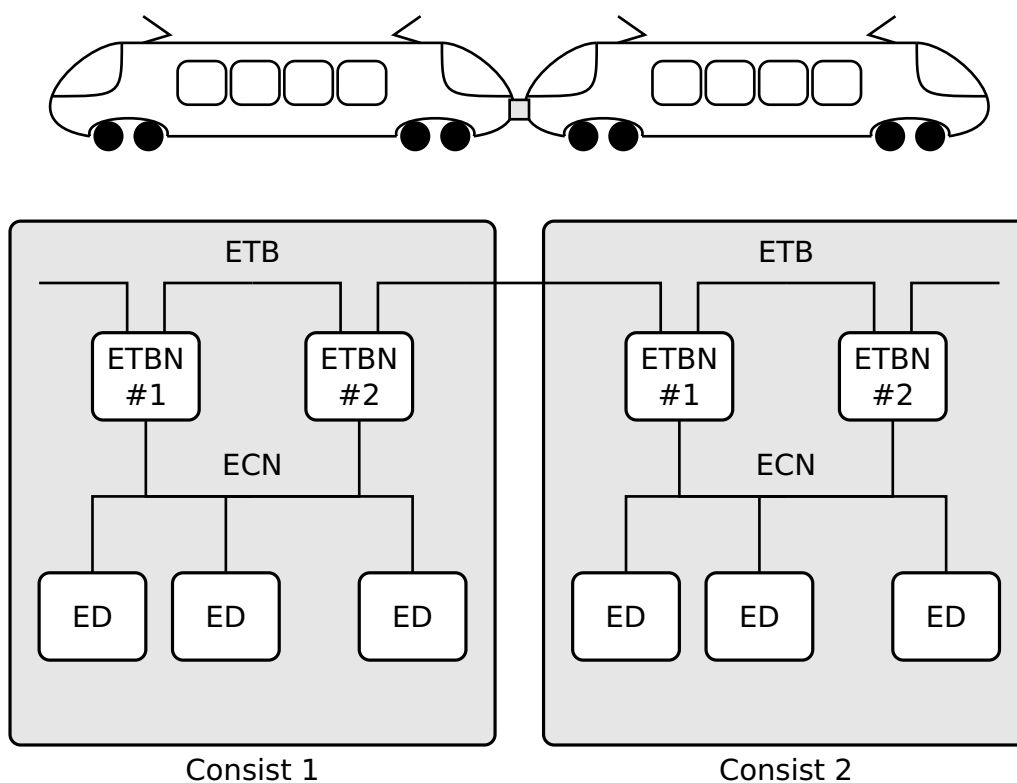



Figure 44.1: IEC 61375 Train topology. Train backbone (ETB) spans the whole train. Each consist has a consist network (ECN). ETBNs route traffic between ETB and ECNs.

- *Link Aggregation Control*: TTDP acts as a link aggregation control protocol on the train backbone, thereby replacing LACP for link aggregation IEC 61375 backbone networks.
- *Discovery of train topology*: With TTDP, ETBNs will discover other ETBNs present on the backbone and exchange information. This TTDP signalling in turn allows each ETBN to gather information about:
 - *Consists*: The identity of present consists (Consist Universally Unique Identifier, or simply *CstUUID*) and their order/position in the train backbone.
 - *ETBNs*: The identity (ETBN MAC address) and order of the ETBNs on the backbone, and also the consist where each of the ETBNs reside. The ETBNs even learn the position of "missing" ETBNs (known, but currently down); this is true as long as at least one ETBN in each consist is up and running.
 - *ECNs*: Every ETBN advertises information about the consist networks (ECNs) present in its consist. Thereby, each ETBN is able to gather information on all ETBNs and ECNs, and how they are interconnected.
- *IP Address assignment*: TTDP is capable of assigning IP addresses dynamically based on the discovered topology. Addresses are allocated from a range defined in IEC 61375-2-5[17], and concern:
 - ETBN addresses on the ETB subnet: Each ETBN is allocated an IP address on the ETB subnet.
 - Train-wide IP subnet allocation for ECN subnets: ECNs typically make use of local (private) addresses in range 10.0.0.0/18. TTDP allocates a train-wide /18-subnet to each of the discovered ECNs.
 - Virtual addresses on ETB subnet: In topologies where ECNs are connected to two (or more) ETBNs for redundancy, TTDP allocates a *virtual* IP address to be shared between the ETBNs on the ETB subnet. A virtual IP address is assigned for each ECN with redundant ETBNs.

The *IP prefix* of the ETB subnet and the train-wide subnets assigned to the ECNs differs depending on *backbone identifier*. TTDP defines four backbone identifiers (0-3), where ID 0 denotes a *Train Control and Monitoring System (TCMS)* backbone, ID 1 a *Multimedia* backbone, and the use for IDs 2 and 3 are not specified.

 **Note**

All ETBNs attached to the same ETB need to be *configured* with the same backbone identifier (e.g. *TCMS(0)*), as this identifier is **not** dynamically computed during the ETB inauguration.

- *Routing entries*: TTDP populates the routing table in each of the ETBNs, thereby enabling routing of traffic between different consist networks.
- *R-NAT entries*: The WeOS TTDP support assumes the use of *1-1 NAT* (referred to as *Railway-NAT* or *R-NAT* in IEC 61375-3-4[18]) to translate ECN IP addresses when routing between ETB and ECN. The 1-1 NAT entries are populated dynamically based on the TTDP IP subnet allocation.
- *TTDP MIB*: IEC 61375-2-5 defines the TTDP MIB, which can be used by a manager station within a consist to monitor TTDP status information on a local ETBN.

WeOS provides some related support, relevant for IEC 61375-2-5 networks.

- *Router redundancy control*: TTDP does not specify the exact mechanism to control router redundancy for topologies where ECNs are connected to more than one ETBN. In similar networks, VRRP ([chapter 32](#)) is the typical choice, but in IEC 61375 backbone networks one cannot rely on VRRP and still be compatible with the standard.

The WeOS support for router redundancy is therefore limited to using VRRP signalling within the ECN network, and to let that VRRP state within the ECN control router redundancy on the ETB too. (See *synchronised VRRP* in [section 32.1.5](#) for more information on this topic.)

- *Unicast routing*: The elected VRRP master will handle the unicast routing between the ETB and specific ECN.
- *Multicast routing*: If multicast forwarding is enabled in a redundant ETBN topology, the elected VRRP master should also be the router forwarding the multicast traffic between ETB and ECN. This is accomplished by using the WeOS *multicast route control* option for VRRP ([section 32.1.6](#)).
- *Inauguration inhibition control*: IEC 61375-2-3 (Communication Profile)[16] defines the mechanism for *ETB inauguration inhibition control*. When inauguration is *inhibited*, the ETBNs keeps the configuration acquired via TTDP, even if the physical topology would change.

As WeOS does not yet support the *communication profile* (IEC 61375-2-3), dedicated OIDs in the WeOS private MIB is provided to control ETB inauguration inhibition.

Note

For proper use of the ETB inhibition control function provided via the WeOS private MIB, it is assumed that the system builder is familiar with the IEC 61375 series of protocols[15, 16, 17, 18]. In particular, redundancy aspects **must** be considered. For example, if the management system only sets Inhibition to "true" in one ETBN, other ETBNs would start to re-inaugurate if that ETBN goes down or becomes unreachable.

44.1.2 Selecting your backbone and consist topology

44.1.2.1 ETB topology

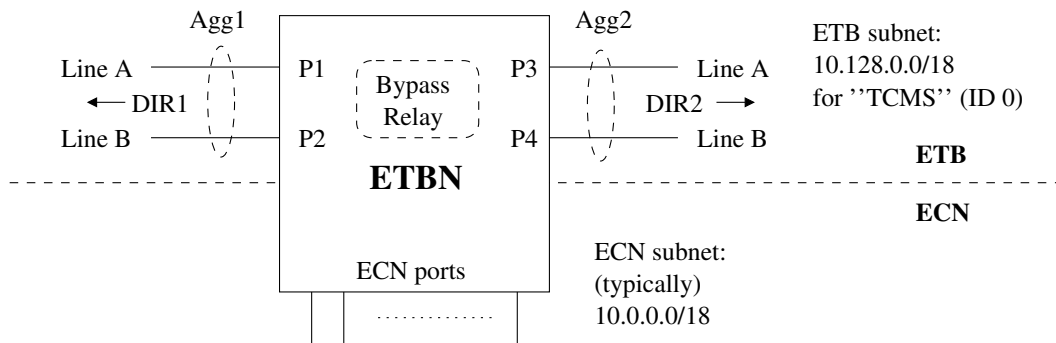

Figure 44.2: Sample ETBN, here with two ETB ports in each direction (P1/P2 and P3/P4) and bypass relay hardware.

Fig. 44.2 shows a sample ETBN. To enable redundancy on the train backbone, the IEC 61375 standard defines two mechanisms applying to the ETBNs:

- Link aggregation: To manage link failures, IEEE 802.1AX link aggregation can be used. IEC 61375 allows up to 4 links to be aggregated in each direction (Line A-D), and specifies the use of TTDP (rather than LACP) to control the link aggregate. The sample ETBN in fig. 44.2 is designed for aggregating two links (A and B) in each direction.
- Bypass relay: The ETBN must be equipped with a bypass relay. When the ETBN is down, the bypass relay ensures that the ETBNs backbone port in

direction 1 and 2 are physically connected. Without this bypass function, a powerless ETBN would split the ETB on each side into isolated segments. The bypass relay in [fig. 44.2](#) would physically connect port P1 to port P3, and port P2 to port P4, when the ETBN has no power.

The IEC standard[17] mandates the backbone network ports (P1-P4 in [fig. 44.2](#)) to be configured for 100 Mbit/s full duplex, and with the MDI/MDIX setting set to (fixed) MDI.

**Note**

As backbone ports are set to fixed MDI mode, the cable between two ETBNs must be a *crossover* cable; otherwise the ports will not get linkup. Furthermore, the bypass relay of the ETBN will conduct a "crossover" when operating in bypass mode; this ensures there will always be an odd number of crossovers between ETBN neighbours. Please see the user guide of your product for a definite description of the bypass relay function.

When designing your backbone, you should also define the backbone type. All ETBNs attached to the same backbone need to be configured with the same backbone ID, which affects the IP prefix used for the ETB subnet and train-wide ECN subnet allocations.

- ID 0 (TCMS): If the backbone is a TCMS backbone, use backbone ID 0. The ETB subnet for ID 0 is *10.128.0.0/18*, and train-wide ECN subnets will be allocated as *10.128.64.0/18*, *10.128.128.0/18*, etc.
- ID 1 (Multimedia): If the backbone is a multimedia backbone, use backbone ID 1. The ETB subnet for ID 1 is *10.160.0.0/18*, and train-wide ECN subnets will be allocated as *10.160.64.0/18*, *10.160.128.0/18*, etc.
- ID 2 and ID 3 (Not specialised): There is no dedicated use for backbone IDs 2 and 3. Using them will affect the subnet prefixes allocated similar to the use of ID 0 or 1 (above). ID 2 implies ETB subnet *10.192.0.0/18*, and ID 3 implies ETB subnet *10.224.0.0/18*, etc.

A train could contain multiple (parallel) backbones, e.g., one backbone for TCMS (ID 0) and an additional backbone for Multimedia (ID 1). Sharing a backbone for both TCMS and Multimedia is outside the scope for IEC 61375.

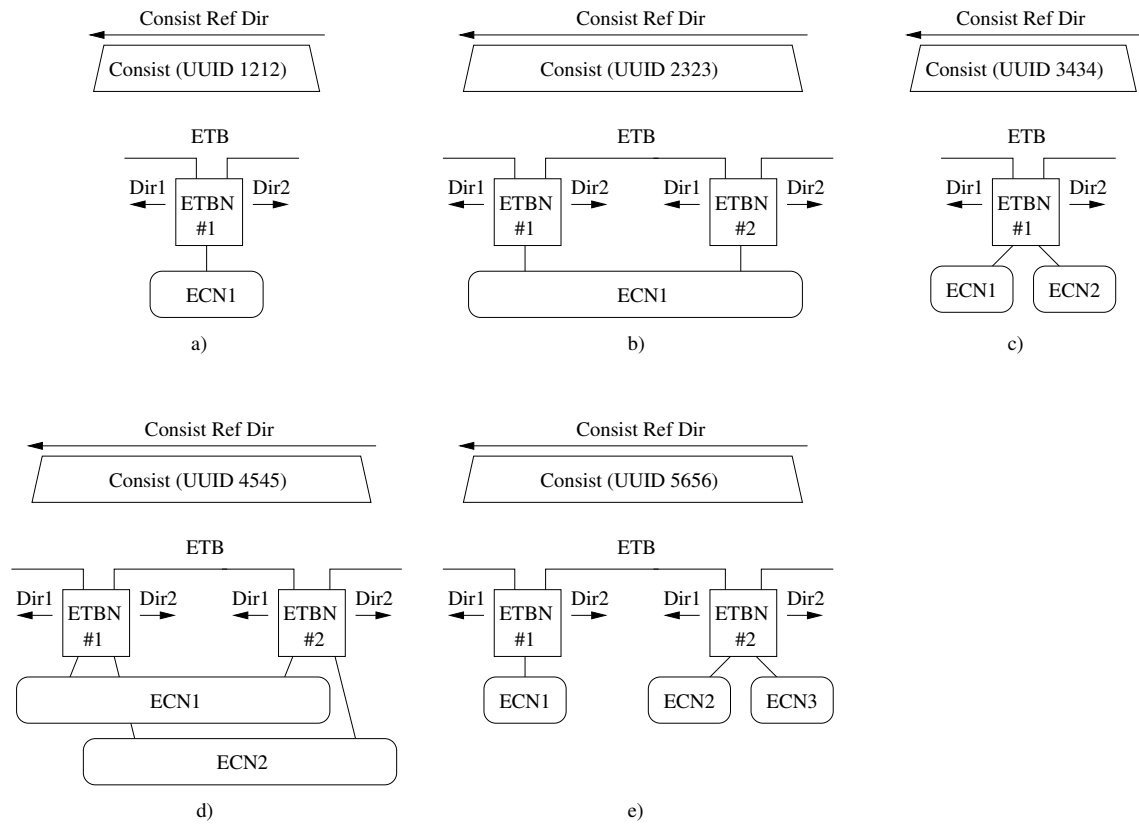

Figure 44.3: Consist topologies: (a) Single ECN with one ETBN, (b) single ECN with redundant ETBNs, (c) multiple ECNs with one ETBN, (d) multiple ECNs with redundant ETBNs, and (e) multiple ECNs with separate ETBNs.

44.1.2.2 Consist and ECN topology

Fig. 44.3 shows high-level views of the consist topologies supported in WeOS v4.33.0:

- *Single ECN with one ETBN:* This topology is shown in fig. 44.3a). It is a simple topology which can be used in train networks where ETBN redundancy is not critical.
- *Single ECN with redundant ETBNs:* This topology is shown in fig. 44.3b). This topology provides redundancy in the communication between ETB and ECN. One of the ETBNs (ETBN1 and ETBN2) will be the active (master) router, while the other is in backup state, being ready to take over if the "master" fails. In WeOS products, VRRP is used to manage the router redundancy (see

[section 44.1.3.5](#)). All ETBNs in the consist will be configured with the same UUID (here "2323").

- *Multiple ECNs with one ETBN*: This topology is shown in [fig. 44.3c](#)). It is possible to have more than one consist network attached to a single ETBN.
- *Multiple ECNs with redundant ETBNs*: This topology is shown in [fig. 44.3d](#)) and aims to illustrate that it is possible to have more than one consist network per ETBN and still achieve redundancy. All ETBNs in the consist will be configured with the same UUID (here "4545").
- *Multiple ECNs with separate ETBNs*: This topology is shown in [fig. 44.3e](#)). It is possible to have more than one network of the types shown in (a)-(d) in the same consist. All ETBNs in the consist will be configured with the same UUID (here "5656").

Below some additional aspects of TTDP is listed, which should be considered when designing and configuring your consists:

- *Consist UUID*: For each consist, you need to allocate a consist UUID. IEC 61375-2-5[17] refers to RFC4122[28] for the method to allocate UUID for your consist. When you have allocated a UUID for a consist, you need to configure that UUID into every ETBN in that consist (see [section 44.1.3.4](#)).
- *Consist Reference Direction*: When *designing* your consist you need to define the *consist reference direction* (section 5.4.4.6.1 of [16]) for the consist.
 - The consist reference direction is decided by the system builder. It is not explicitly part of the TTDP configuration, but it is implicitly configured via the ETBN *dir1* and *dir2* settings. Thus, a management system can implicitly learn the orientation of a consist by reading out the direction of any ETBN located in that consist and compare that with the *ETB reference direction* calculated by TTDP.
 - All ETBNs in the consist must set their *dir1* setting as the aggregate pointing in the consist's *decided* reference direction (see section 8.2.3 of IEC 61375-2-5 standard[17]). In [fig. 44.3](#) you can see that *Dir1* of every ETBN points in the consist reference direction decided by the train builder. Note in particular that when there are multiple ETBNs per consist, as in [fig. 44.3b](#)), d) and e), all of the ETBNs must have their *Dir1* settings aligned. For configuration examples, see [section 44.1.3.4](#).
- *ECN LAN topology*: IEC 61375 standards[15, 18] allows for a set of different physical ECN topologies, including *ring topology* which provides redundancy

within the ECN. FRNT ([chapter 16](#)) is suitable as ring protocol within the ECN.

 **Note**

In topologies with multiple ECNs per ETBN, one can either (a) use VLANs to allow multiple ECNs over a single FRNT ring, or (b) build multiple separate FRNT rings. In the latter case the ETBNs would be connected to, but typically not part of the FRNT rings (placing routing functionality and layer-2 redundancy functionality in different units is generally a good design principle).

- *Unit configuration and replacement:* For easy deployment and replacement of WeOS train routers (ETBNs) and vehicle switches, use of the WeOS USB deployment functionality ([section 7.1.7](#)) is recommended.

44.1.3 A configuration example

In this section we will go through the steps to setup the ETBNs of an example consist, given the *bogus* consist UUID "1111...". You could then configure another consist, e.g., with UUID "2222..." and connect the two consists together.

- The example assumes the use of RFR-212-FB.
- The configuration example focus on ETBN #1 in [fig. 44.4](#), but most of the settings would be the same for ETBN #2.
- This example assumes backbone ID $TCMS(0)$, but could be adapted to other backbone IDs.

44.1.3.1 Backbone ports and aggregates

The RedFox Rail (RFR-212-FB) router[60] is designed to act as an ETBN with two redundant links in each direction: X9-X10 in one direction and X11-X12 in the other. The bypass relay connects ports $X9 \leftrightarrow X11$ and ports $X10 \leftrightarrow X12$ when the unit has no power. (See the RFR-212-FB user guide[60] for a definite description.) The ETB ports **must** be configured with *fixed 100 Mbit/s full duplex* and with *fixed MDI*. ETB ports must be connected using a cross-over cable.

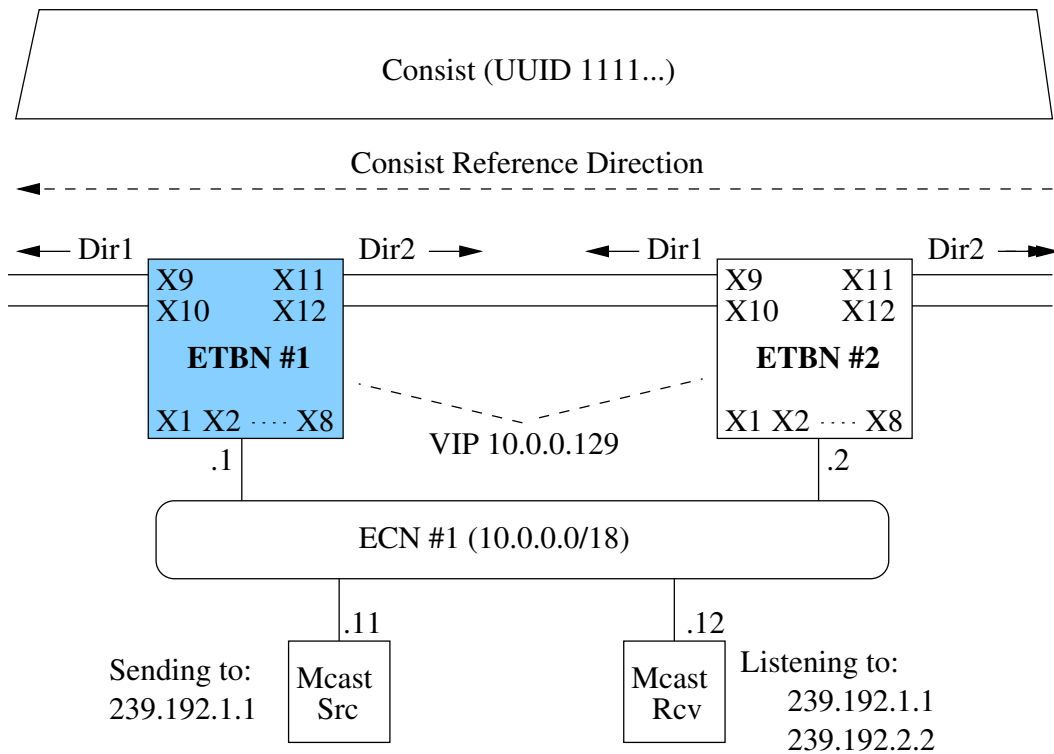

Figure 44.4: Example consist with two ETBNs connected to one ECN.

Example

```
example:/config/#> port x9-x12
example:/config/port-ethX9-X12/#> speed-duplex 100-full
example:/config/port-ethX9-X12/#> mdix-mode mdi
example:/config/port-ethX9-X12/#> leave
Configuration activated. Remember "copy run start" to save to flash (NVRAM).
example:/#>
```

The backbone ports form two aggregates, one in each direction. As of WeOS v4.33.0, you need to configure these aggregates explicitly as "static" aggregates (configuration in [section 44.1.3.4](#) sets TTDP as control protocol for these aggregates). The design of the RFR-212-FB bypass relay[60] assumes that you form your aggregates with ports X9-X10, and ports X11-X12 respectively.

Example

```
example:/#> configure
example:/config/#> aggregate a1
Creating new aggregate a1
a1: Invalid settings: No ports defined for aggregate.
example:/config/aggregate-a1/#> ports x9-x10
example:/config/aggregate-a1/#> mode static
example:/config/aggregate-a1/#> end
example:/config/#> aggregate a2
Creating new aggregate a2
a2: Invalid settings: No ports defined for aggregate.
example:/config/aggregate-a2/#> ports x11-x12
example:/config/aggregate-a1/#> mode static
example:/config/aggregate-a2/#> leave
Configuration activated. Remember "copy run start" to save to flash (NVRAM).
example:/#>
```

44.1.3.2 Backbone and Consist VLANs

Next you create VLANs for the train backbone (ETB) and consist network (ECN) ports. In this example we assume VLAN 1 (default VLAN) is used for the ECN and VLAN 100 for the ETB. As of WeOS v4.33.0 you need to create an additional VLAN (VLAN 492) for TTDP signalling on the backbone ports (this requirement may go away in future releases of WeOS).

First we configure the ETB VLAN (here VLAN 100). The IEC 61375 standard mandates that IGMP snooping is disabled on the ETB. Data is sent untagged. Naming the ETB VLAN "etb" is only for documentation purposes, thus can be skipped.

Example

```
example:/#> configure
example:/config/#> vlan 100
Creating new VLAN vid:100 with name: vlan100
example:/config/vlan-100/#> untagged x9-x12
Moving untagged port Eth X9 from vid 1 to vid 100.
Moving untagged port Eth X10 from vid 1 to vid 100.
Moving untagged port Eth X11 from vid 1 to vid 100.
Moving untagged port Eth X12 from vid 1 to vid 100.
example:/config/vlan-100/#> no igmp
example:/config/vlan-100/#> name etb
example:/config/vlan-100/#> end
example:/config/#>
```

No specific configuration is needed for the ECN VLAN (here VLAN 1). In this example, it is assumed that IGMP snooping is enabled and desired on the ECN VLAN,

and that all other ports should be associated with VLAN 1 (untagged), which is typically the default for VLAN 1. In the example below we also assign the ECN VLAN the name "ecn1"; this is only for documentation purposes, thus can be skipped.

Example

```
example:/config/#> vlan 1
example:/config/vlan-1/#> name ecn1
example:/config/vlan-1/#> end
example:/config/#>
```

Finally you create VLAN 492 for TTDP signalling. The backbone ports are associated tagged, and this VLAN is configured with highest priority and IGMP snooping disabled.

Example

```
example:/config/#> vlan 492
Creating new VLAN vid:492 with name: vlan492
example:/config/vlan-492/#> tagged x9-x12
example:/config/vlan-492/#> no igmp
example:/config/vlan-492/#> priority 7
example:/config/vlan-492/#> leave
Configuration activated. Remember "copy run start" to save to flash (NVRAM).
example:/#>
```

44.1.3.3 Network Interface Configuration

The ETB network interface (here *vlan100*) will have its IP address assigned by TTDP, thus the *inet* method is configured accordingly. Furthermore, *vlan100* is configured as *always up* ("**enable always**", see [section 22.2.1](#)). The purpose is to avoid unnecessary packet loss when a neighbour ETBN comes up or goes down. Such an event may otherwise cause a short link down/up event, which in turn could result in longer packet loss due to protocol dynamics. Giving an upstream interface a low "distance" (here "**distance 1**") is a good habit, although it is not strictly required in this case.

Example

```
example:/#> configure
example:/config/#> iface vlan100
example:/config/iface-vlan100/#> inet ttdp
example:/config/iface-vlan100/#> enable always
example:/config/iface-vlan100/#> distance 1
```

```
example:/config/iface-vlan100/#> end
example:/config/#>
```

The IP address for the ECN interface (here *vlan1*) is typically an address in the *10.0.0.0/18* range. That is, WeOS ETBNs assume that "local" subnets are used within the ECN, and TTDP will automatically assign NAT rules (R-NAT) to map between the local subnet and the train wide subnet assigned to the ECN by TTDP (see also "**consist-net**" setting in [section 44.1.3.4](#)). In this example, the ETBN is assigned address "**10.0.0.1/18**" on its ECN interface. (If you have a second ETBN in your ECN, you could give that unit, e.g., address "**10.0.0.2/18**" on its ECN interface.)

Before configuring *vlan1*, existing addresses (if any) are removed and the address method is set to "**inet static**".

Example

```
example:/config/#> iface vlan1
example:/config/iface-vlan1/#> no address
example:/config/iface-vlan1/#> inet static
example:/config/iface-vlan1/#> address 10.0.0.1/18
example:/config/iface-vlan1/#> distance 2
example:/config/iface-vlan1/#> end
```

The interface *vlan492* is used for TTDP signalling. This interface should be configured as *always up* and without IP address. In future releases of WeOS, this explicit configuration of interface *vlan492* may not be necessary.

Example

```
example:/config/#> iface vlan492
example:/config/iface-vlan492/#> inet static
example:/config/iface-vlan492/#> enable always
example:/config/iface-vlan492/#> no address
example:/config/iface-vlan492/#> no management
example:/config/iface-vlan492/#> leave
Configuration activated. Remember "copy run start" to save to flash (NVRAM).
example:/#>
```

44.1.3.4 Configuring TTDP settings

This section describes the TTDP settings needed to tie the configuration together. First we specify which link aggregates to use in ETB direction 1 and 2. As described in [section 44.1.3](#), this example assumed that *aggregate a1* (ports X9-X10)

points in the *consist reference direction* (dir1), and *aggregate a2* (ports X11-X12) in the opposite direction (dir2).

Example

```
example:/#> configure
example:/config/#> ttdp
Activating TTDP with default settings.
example:/config/ttdp/#> dir1 a1
example:/config/ttdp/#> dir2 a2
```

In our example we use one ECN (ECN #1) in the consist, with two ETBNs (#1 and #2) for redundancy. The consist topology is declared as follows (every ETBN in the consist needs to declare the *whole* consist topology):

Example

```
example:/config/ttdp/#> node 1 consist-net 1
example:/config/ttdp/#> node 2 consist-net 1
```

The ETBN also needs to define its own position/identity in the consist topology. The example below is for ETBN #1 in the consist (for ETBN #2 you simply change the value to "2"):

Example

```
example:/config/ttdp/#> local-id 1
```

Note

If you have more than one ETBN in your consist, you need to assign the local ID in ascending order (1, 2, 3, ...), starting from the front of the consist.

Next you need to declare what interface on the ETBN that maps to ECN #1. In our case, it is interface *vlan1* that is connected to ECN #1. By defining the ECN interface, WeOS will *implicitly* setup the 1-1 NAT (R-NAT) rules between the local ECN subnet (10.0.0.0/18) and the *train wide* ECN subnet allocated by TTDP. WeOS will also setup implicit filter rules to allow the NAT:ed traffic to pass through the WeOS firewall¹.

¹The 1-1 NAT and *filter allow* rules implicitly added by TTDP are *hidden* in the sense that they are not listed by the "**show firewall**" command (section 33.3.14).

Example

```
example:/config/ttdp/#> consist-net 1 vlan1
```

The backbone ID in this example is set to TCMS (ID 0).

Example

```
example:/config/ttdp/#> backbone-id tcms
```

All ETBNs in the consist (here ETBN1 and ETBN2) need to be configured with the same (universally unique) consist identifier (CstUUID). In this example the bogus UUID "all-ones" (1111...) is used, but as mentioned in [section 44.1.2.2](#) you should allocate UUIDs for your consists according to RFC4122[28].

Example

```
example:/config/ttdp/#> uuid 11111111-1111-1111-1111-111111111111
```

The TTDP configuration for ETBN1 would then be as shown below. (The configuration for ETBN2 would be the same, except that *Local ETBN ID* would be set to "2".)

Example

```
example:/config/ttdp/#> show
Status      : Enabled
Local ETBN ID : 1
Direction 1 : a1
Direction 2 : a2
Backbone ID  : tcms
Consist UUID : 11111111-1111-1111-1111-111111111111
ECN ID 1 on iface vlan1
Consist topology :
  Local ETBN ID 1 connected to ECN ID 1
  Local ETBN ID 2 connected to ECN ID 1
Multicast routing:
  Routing of default IEC61375-2-5 groups: DISABLED
example:/config/ttdp/#> leave
Configuration activated. Remember "copy run start" to save to flash (NVRAM).
example:/#>
```

44.1.3.5 VRRP Configuration

The example consist we are configuring has two ETBNs connected to the ECN to achieve redundancy if one ETBN goes down. To handle router redundancy, WeOS makes use of VRRP ([chapter 32](#)) with some twists:

- The virtual IP address on the ETB is assigned dynamically by TTDP, see "**address ttdp**" below.
- As mandated by IEC 61375-2-5, *virtual MAC addresses* are not used on the ETB. Instead the ETBN's *physical MAC address* (here the MAC address of interface *vlan100*) is used.
- No VRRP signalling takes place on the ETB (interface *vlan100*). As ETBN1 and ETBN2 will not hear each other on *vlan100*, the VRRP master election depends solely on the VRRP state on the ECN interface (synchronised VRRP).

In the example configuration shown below, the virtual IP on the ECN (interface *vlan1*) has been selected to *10.0.0.129*. Here VRRP version 3 has been selected with advertisement interval 200 milliseconds, but use of VRRP version 2 would also be possible.

The configuration below shows ETBN1, but would be identical for ETBN2 except for the VRRP priority (ETBN2 would have a lower priority, e.g., "**priority 80**", to let ETBN1 be elected as master by default).

For more information regarding VRRP configuration in WeOS, please see [chapter 32](#).

Example

```
example:/#> configure
example:/config/#> router
example:/config/router/#> vrrp 1
Creating new vrrp instance: 1
Invalid settings: Interface not set.
example:/config/router/vrrp-1/#> iface vlan1
Invalid settings: Invalid IPv4 address.
example:/config/router/vrrp-1/#> address 10.0.0.129
Invalid settings: VRID invalid. Valid values: 1 to 255.
example:/config/router/vrrp-1/#> vrid 1
example:/config/router/vrrp-1/#> version 3
example:/config/router/vrrp-1/#> interval 200 msec
example:/config/router/vrrp-1/#> priority 120
example:/config/router/vrrp-1/#> preempt delay 2
example:/config/router/vrrp-1/#> end
example:/config/router/#> vrrp 2
Creating new vrrp instance: 2
Invalid settings: Interface not set.
```

```
example:/config/router/vrrp-2/#> iface vlan100
Invalid settings: Invalid IPv4 address.
example:/config/router/vrrp-2/#> address ttdp
Invalid settings: VRID invalid. Valid values: 1 to 255.
example:/config/router/vrrp-2/#> vrid 2
example:/config/router/vrrp-2/#> version 3
example:/config/router/vrrp-2/#> interval 200 msec
example:/config/router/vrrp-2/#> priority 120
example:/config/router/vrrp-2/#> preempt delay 2
example:/config/router/vrrp-2/#> sync 1
example:/config/router/vrrp-2/#> leave
Configuration activated. Remember "copy run start" to save to flash (NVRAM).
example:/#>
```

44.1.3.6 Multicast routes

The configuration steps conducted so far would suffice if you only wish to route IP unicast packets through the ETBNs. To also route IP multicast some additional configuration steps are required in the ETBNs. To illustrate the configuration, two similar consists are used as shown in [fig. 44.5](#).

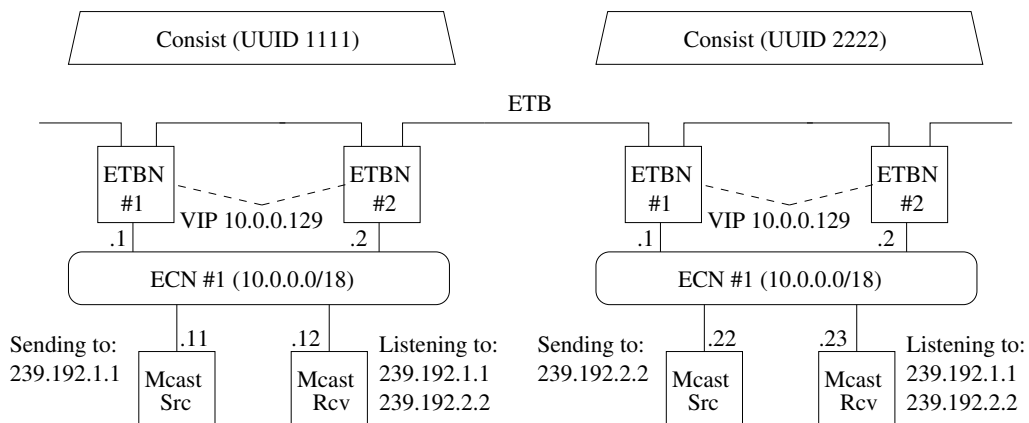

Figure 44.5: A sample setup with multicast between two consists.

- **Multicast forwarding:** IP multicast forwarding must be enabled on all ETBNs ([chapter 31](#)).

Example

```
example:/#> configure
example:/config/#> ip
example:/config/ip/#> multicast-forwarding
```

- *Configure (static) multicast routes:* In our example we wish to route multicast group 239.192.1.1 from a CCTV in *Consist 1111* (source IP 10.0.0.11/18) to a monitor in *Consist 2222*, and a multicast group 239.192.2.2 in the opposite direction (source IP 10.0.0.22/18). The multicast routes of ETB1 and ETB2 (*Consist 1111*) would then be as shown below. Note that configuration of multicast routes handled by TTDP are configured in the TTDP context. No incoming interface (or source IP address) is defined; any multicast packet to the given multicast group will be accepted as long as they come in on an ETB or ECN interface different from the outgoing interface.

Example

```
example:/#> configure
example:/config/#> ttdp
example:/config/ttdp/#> mroute group 239.192.1.1 out etb
example:/config/ttdp/#> mroute group 239.192.2.2 out 1
```

As shown above, "**out etb**" symbolically denotes that traffic should go out the ETB interface (internally mapped to *vlan100*), while "**out 1**" denotes that traffic should go out on ECN 1 (internally mapped to *vlan1*).

In *Consist 2222*, ETBN1 and ETBN2 would have almost the "inverse" configuration to achieve the desired result.

Example

```
example:/#> configure
example:/config/#> ttdp
example:/config/ttdp/#> mroute group 239.192.2.2 out etb
example:/config/ttdp/#> mroute group 239.192.1.1 out 1
```

- *IEC 61375-2-5 default multicast routes:* Section 6.4.4 of the IEC 61375-2-5 standard[17] defines default multicast routes for *All-Consists* (239.192.0.0) and *All hosts in Consist position X* (239.192.0.X). If desired, these multicast routes can be enabled using the "**default-mroutes**" command.

Example

```
example:/#> configure
example:/config/#> ttdp
example:/config/ttdp/#> default-mroutes
```

- *Handle ETBN redundancy:* In our example, there are two ETBNs connected to the ECN to achieve redundancy. IEC 61375-2-5 does not specify the algorithm to select which ETBN should route multicast packets in case of redundancy, but common practice is to extend the VRRP mechanism to also apply to multicast ([section 32.1.6](#)). When using TTDP in WeOS, the handling of ETBN redundancy for multicast is handled implicitly. Thus, you need not (and **should not**) enable **"mroute-ctrl"** in VRRP context. The VRRP configuration conducted in [section 44.1.3.5](#) would suffice without change.

44.1.3.7 Inhibition control

The inhibition function provides a mechanism to lock the configuration dynamically negotiated by TTDP. The mechanism should eventually be provided via the *communication profile* (IEC 61375-2-3[16]), which is not yet supported in WeOS. Instead WeOS includes dedicated SNMP support for inhibition control via the private WESTERMO-WEOS-MIB.

ETB Inhibition OID:

```
iso(1).org(3).dod(6).private(4).enterprises(1).westermo(16177).common(2).
weos(1).net(4).ttdp(2).etbnInhibitionEnabled(1)
```

This section gives some basic hints on how to access and set the inhibition control OID, but does not aim to fully describe how to use inhibition control in your train control system. As stated in [section 44.1.1](#) it is assumed that the system builder is familiar with the IEC 61375 standards and considers redundancy aspects of inhibition control.

To allow for setting the ETB Inhibition OID, the WeOS unit must be configured to allow SNMP 'write-access'. Both SNMPv2c and SNMPv3 may be used, but the recommendation is to use SNMPv3 ([section 6.1.4](#)). An example is shown below, with the sample SNMPv3 read-write user "train".

Example

```
example:/#> configure
example:/config/#> snmp-server
example:/config/snmp/#> rwuser train auth sha1 TrainS3cret
example:/config/snmp/#> leave
example:/#> cp running start
```

Below is an example for reading out the current inhibition state for an ETBN with IP address *10.0.0.1*, using the (Unix) Net-SNMP **"snmpget"** command. Here the value is *False(2)*.

Example

```
mypc:~$ snmpget -v3 -u train -l authNoPriv -a SHA -A TrainS3cret 10.0.0.1  
1.3.6.1.4.1.16177.2.1.4.2.1.0  
iso.3.6.1.4.1.16177.2.1.4.2.1.0 = INTEGER: 2
```

Below is a corresponding example where the "inhibition flag" is set to True(1). (The setting is *volatile* in the sense that it is reset to False(2) upon reboot or restart of TTDP.)

Example

```
mypc:~$ snmpset -v3 -u train -l authNoPriv -a SHA -A TrainS3cret 10.0.0.1  
1.3.6.1.4.1.16177.2.1.4.2.1.0 i 1  
iso.3.6.1.4.1.16177.2.1.4.2.1.0 = INTEGER: 1
```

44.2 Managing TTDP settings via the CLI

Command	Default	Section
<u>TTDP Settings</u>		
[no] ttdp	Disabled	Section 44.2.1
[no] enable	Enabled	Section 44.2.2
[no] dir1 <AGG1>		Section 44.2.3
[no] dir2 <AGG2>		Section 44.2.4
[no] backbone-id <0..3 tcms mm>	tcms(0)	Section 44.2.5
[no] uuid <UUID>	00...	Section 44.2.6
[no] consist-net <ECN_ID> <IFNAME>		Section 44.2.7
[no] node <LOCAL_ETBN_ID>		Section 44.2.8
consist-net <ECN_ID_LIST>		
[no] local-id <LOCAL_ETBN_ID>	1	Section 44.2.9
[no] default-mroutes	Disabled	Section 44.2.10
[no] mroute group <MCADDR>		Section 44.2.11
out <NET_ID_LIST>		
<u>Show TTDP Status</u>		
[show] ttdp conn		Section 44.2.12
[show] ttdp neigh		Section 44.2.13
<u>Related Settings</u>		
Port Settings		Sec. 44.1.3.1, Chap. 10
Link Aggregates		Sec. 44.1.3.1, Chap. 20
VLANs		Sec. 44.1.3.2, Chap. 15
Network Interface		Sec. 44.1.3.3, Chap. 22
VRRP		Sec. 44.1.3.5, Chap. 32
Multicast forwarding		Sec. 44.1.3.6, Chap. 31

44.2.1 Managing TTDP

Syntax [no] ttdp

Context [Global Configuration](#) context

Usage Enter or delete the TTDP Configuration context. Use command **"ttdp"** to enter the context. If the [TTDP Configuration](#) context does not already exist, entering it will create the context with default settings.

Use **"no ttdp"** to remove the TTDP context and all its settings.

Use **"show ttdp"** to show all TTDP settings (also available as **"show"** command within the TTDP Configuration context).

Default values Disabled

44.2.2 Enable TTDP

Syntax enable

Context [TTDP Configuration](#) context

Usage Activates and deactivates TTDP.

Use **"enable"** to activate TTDP. **"no enable"** disables TTDP, without removing the configured TTDP settings.

Use **"show enable"** to view the current enable setting.

Default values Enabled

44.2.3 Direction 1 Aggregate

Syntax dir1 <AGG1>

Context [TTDP Configuration](#) context

Usage Set which aggregate that is connected in direction 1 (consist reference direction). Configuring the **"dir1"** aggregate is required for TTDP to be activated.

"no dir1" resets direction 1 to the default setting (disabled).

Use **"show dir1"** to view the current aggregate configured for direction 1.

Default values Disabled

44.2.4 Direction 2 Aggregate

Syntax dir2 <AGG2>

Context [TTDP Configuration](#) context

Usage Set which aggregate that is connected in direction 2 (opposite to consist reference direction). Configuring the **"dir2"** aggregate is required for TTDP to be activated.

"no dir2" resets direction 2 to the default setting (disabled).

Use **"show dir2"** to view the current aggregate configured for direction 2.

Default values Disabled

44.2.5 Backbone-id

Syntax backbone-id <0-3|tcms|mm>

Context [TTDP Configuration](#) context

Usage Set ID of the backbone network.

- 0, for TCMS
- 1, for Multimedia
- 2, not specialised
- 3, not specialised

"no backbone-id" resets the backbone ID to the default setting (TCMS).

Use **"show backbone-id"** to view the current backbone ID setting.

Default values tcms(0)

44.2.6 Consist UUID setting

Syntax uuid <UUID>

Context [TTDP Configuration](#) context

Usage Set consist UUID.

Use **"uuid <UUID>"** to configure the consist UUID of the ETBN. The same UUID must be used for all ETBNs in the same consist, and the UUID must be unique for that consist.

"uuid" generates a random UUID.

"no uuid" resets the UUID to the default setting, i.e., all zeros (000...).

Use **"show uuid"** to view the current UUID setting.

Default values 00000000-0000-0000-0000-000000000000

44.2.7 Consist network setting

Syntax `consist-net <ECN_ID> <IFNAME>`

Context [TTDP Configuration](#) context

Usage Define the mapping of interface to consist network on this ETBN, e.g., `"consist-net 1 vlan1"` specifies that local interface `vlan1` is connected ECN 1.

If this ETBN is connected to multiple consist networks, then one mapping per connected consist network is needed.

`"no consist-net"` removes all configured ECN/interface mappings.

Use `"show consist-net"` to view the current consist network configuration.

Default values Not applicable.

44.2.8 Consist network configuration

Syntax `node <LOCAL_ETBN_ID> consist-net <ECN_ID_LIST>`

Context [TTDP Configuration](#) context

Usage Describe the consist network topology of the consist this ETBN resides in. That is, an ETBN should enter

- a `"node"` command for every ETBN (`LOCAL_ETBN_ID`) in its consist,
- where each `"node"` entry specifies the ECN(s) (`ECN_ID(s)`) they are connected to.

For example, use `"node 1 consist-net 1,2"` to specify that ETBN 1 is connected to ECNs 1 and 2.

`"no node <LOCAL_ETBN_ID>"` removes the settings for given node.

Use `"show node"` to view the current list of ETBNs to consist network connections.

Default values Not applicable

44.2.9 Local ID

Syntax `[no] local-id <LOCAL_ETBN_ID>`

Context [TTDP Configuration](#) context

Usage Set local ID to indicate the position (LOCAL_ETBN_ID) of this ETBN within the consist.

"no local-id" resets local-id to default setting (ID 1).

Use "show local-id" to view the current local ID setting.

Default values 1

44.2.10 Default 61375-2-5 multicast routes

Syntax [no] default-mroutes

Context [TTDP Configuration](#) context

Usage Configure standardised IEC 61375-2-5 multicast routes.

Sets up the train-scope multicast routes defined in IEC61375-2-5 section 6.4.4.

"no default-mroutes" disables the default routes.

Use "show default-mroutes" to view the current setting.

Default values Disabled

44.2.11 TTDP Multicast routes

Syntax [no] mroute group <MCADDR> out <NET_ID_LIST>

Context [TTDP Configuration](#) context

Usage Configure IEC61375 multicast routes.

For custom routes, <MCADDR> may be inside the RFC 2365 "organization scope" range (239.192.0.0/14), but must not be inside the IEC 61375-2-5 reserved range (239.192.0.0/24). The specified group will be routed to <NET_ID> from every other connected ECN as well as from the local ETB.



Note

Currently this setting needs to be configured on all the potential source and receiver ETBNs.

<NET_ID> can be a numeric ECN ID or the special value **"etb"**, which maps to the ETB interface. In that case the group will be routed from all local CNs to the ETB.

Example

Example (assuming local ECNs 1,2,3):

```
example:/#> configure
example:/config/#> ttdp
example:/config/ttdp/#> mroute group 239.192.1.1 out 1,2,etb
```

will set up the following routes for 239.192.1.1:

```
ETB -> ECN 1, ECN 2
ECN 1 -> ECN 2, ETB
ECN 2 -> ECN 1, ETB
ECN 3 -> ECN 1, ECN 2, ETB
```

Use **"no mroute"** to remove all configured multicast routes.

Use **"show mroute"** to view the current multicast routes handled by TTDP.

Default values Not applicable

44.2.12 Show topology status

Syntax show ttdp conn

Context Admin Exec context

Usage Show the connectivity table (physical topology) and its CRC value. It also shows the train network directory (logical topology) and its CRC value named *etbTopoCount*.

Use **"show ttdp conn"** to view the current connectivity table and train network directory.

44.2.13 Show message frame status

Syntax show ttdp neigh

Context Admin Exec context

Usage Show the content of received HELLO frames from neighbouring ETBNs and TOPOLOGY frames from all nodes on the ETB.

Use **"show ttdp neigh"** to view the current received TOPOLOGY and HELLO frames.

Part VII

Appendixes

Acronyms and abbreviations

3DES	Triple DES
AAA	Authentication, Authorisation and Accounting
AH	Authentication Header
ASCII	American Standard Code for Information Interchange
AES	Advanced Encryption Standard
AVT	Adaptive VLAN Trunking (Westermo proprietary dynamic VLAN function)
CA	Certificate Authority
CIDR	Classless Inter-Domain Routing
CLI	Command Line Interface
CN	Common Name (X.509 certificate term)
CPU	Central Processing Unit
CoS	Class of Service (Layer-2 Priority)
dBm	Power ratio in dB referenced to 1 mW. (Used for DDM SFP optic power representation.)
DDM	Digital Diagnostics Monitoring
DDNS	Dynamic DNS
DDOS	Distributed Denial of Service (Attack)
DES	Data Encryption Standard
DH	Diffie-Hellman
DHCP	Dynamic Host Configuration Protocol
DN	Distinguished Name (X.509 certificate term)
DNS	Domain Name System
DOM	Digital Optics Monitoring
DPD	Dead Peer Detection
DPI	Deep Packet Inspection
DSCP	Differentiated Services Code Point

DSL	Digital Subscriber Line
EAP	Extensible Authentication Protocol
ECN	Enhanced Congestion Notification
ECN	Ethernet Consist Network (IEC 61375)
ED	End-device (IEC 61375)
ESP	Encapsulating Security Payload
ETB	Ethernet Train Backbone (IEC 61375)
ETBN	Ethernet Train Backbone Node (IEC 61375)
FDB	Forwarding Database (MAC forwarding)
FRNT	Fast Reconfiguration of Network Topology
GRE	Generic Routing Encapsulation
HTTP	Hypertext Transfer Protocol
HTTPS	Secure HTTP (HTTP over SSL/TLS)
I/O	Input/Output
IGMP	Internet Group Management Protocol
IKE	Internet Key Exchange
IKEv1	IKE version 1
IP	Internet Protocol
IPsec	IP Security
IPv4	IP version 4
IPv6	IP version 6
LAN	Local Area Network
LDAP	Lightweight Directory Access Protocol
LED	Light Emitting Diode
LFF	Link Fault Forward
LLDP	Link Layer Discovery Protocol
LZO	Lempel Ziv Oberhumer (compression, SSL VPN/OpenVPN)
MD5	Message Digest 5
MIB	Management Information Base
MRC	Media Redundancy Client (see MRP)
MRM	Media Redundancy Manager (see MRP)
MRP	Media Redundancy Protocol (IEC 62439-2)
TU	Maximum Transfer Unit
NAPT	Network Address and Port Translation
NAT	Network Address Translation
NAT-T	NAT Traversal
NBMA	Non-Broadcast Multiple Access
NTP	Network Time Protcol

OID	Object Identifier
OSPF	Open Shortest Path First
QI	Query Interval (IGMP)
QRI	Query Response Interval (IGMP)
PAF	PME Aggregation Function (SHDSL link bonding)
PC	Personal Computer
PCP	Priority Code Point (IEEE 802.1p)
PEM	Privacy Enhanced Mail (X.509 certificate term)
PFS	Perfect Forward Secrecy
PHB	Per-Hop Behaviour
PKCS	Public Key Cryptography Standards
PKI	Public Key Infrastructure
PNAC	Port-based Network Access Control
PPP	Point to Point Protocol
R-NAT	Railway NAT (IEC 61375)
RIP	Routing Information Protocol
RAM	Random Access Memory
RDN	Relative Distinguished Name (X.509 certificate term)
RMON	Remote Monitoring
RSA	Rivest, Shamir, and Adleman (public key encryption algorithm)
SHDSL	Symmetric High-speed Digital Subscriber Line
SFP	Small Form-factor Pluggable (transceiver module)
SHA	Secure Hash Algorithm
SHA-1	Secure Hash Algorithm 1
SHA-2	Secure Hash Algorithm 2
SHA-256	SHA-2 with 256 bits
SNMP	Simple Network Management Protocol
SNR	Signal to Noise Ratio
SNTP	Simple NTP
SSH	Secure SHell
SSL	Secure Socket Layer
TCMS	Train Control and Monitoring System
TLS	Transport Layer Security
ToS	Type of Service
TTDP	Train Topology Discovery Protocol (IEC 61375)
TTL	Time To Live (e.g., LLDP and IP packets)
USB	Universal Serial Bus
UUID	Universally Unique IDentifier

VFS	Virtual File System
VIP	Virtual IP Address (VRRP)
VLAN	Virtual LAN
VPN	Virtual Private Network
VRID	Virtual Router Identifier (VRRP)
VRRP	Virtual Router Redundancy Protocol
WAN	Wide Area Network
WDT	Watchdog Timer
WeOS	Westermo OS
WOL	Wake-On-LAN

Bibliography

- [1] S. Alexander and R. Droms. DHCP Options and BOOTP Vendor Extensions. rfc 2132, IETF, March 1997.
- [2] P. Almquist. Type of Service in the Internet Protocol Suite. rfc 1349, IETF, July 1992.
- [3] MicroLok II Peer Protocol Application Guidelines. Ansaldo STS, SM 9726, Rev. 2, May 2009.
- [4] M. Christensen, K. Kimball, and F. Solensky. Considerations for Internet Group Management Protocol (IGMP) and Multicast Listener Discovery (MLD) Snooping Switches. rfc 4541, IETF, May 2006.
- [5] G. Clark. Telnet Com Port Control Option. rfc 2217, IETF, October 1997.
- [6] S.E. Deering. Host extensions for IP multicasting. rfc 1112, IETF, August 1989.
- [7] R. Droms. Dynamic Host Configuration Protocol. rfc 2131, IETF, March 1997.
- [8] D. Farinacci, T. Li, S. Hanks, D. Meyer, and P. Traina. Generic Routing Encapsulation (GRE). rfc 2784, IETF, March 2000.
- [9] W. Fenner. Internet Group Management Protocol, Version 2. rfc 2236, IETF, November 1997.
- [10] R. Gerhards. The Syslog Protocol. rfc 5424, IETF, March 2009.
- [11] D. Grossman and J. Heinanen. Multiprotocol Encapsulation over ATM Adaptation Layer 5. rfc 2684, IETF, September 1999.
- [12] B. Haberman and J. Martin. Multicast Router Discovery. rfc 4286, IETF, December 2005.
- [13] C.L. Hedrick. Routing Information Protocol. rfc 1058, IETF, June 1988.

-
- [14] R. Hinden and Ed. Virtual Router Redundancy Protocol (VRRP). rfc 3768, IETF, April 2004.
 - [15] IEC 61375-1 Electronic railway equipment – Train communication network (TCN) – Part 1: General architecture. IEC, 2012.
 - [16] IEC 61375-2-3 Electronic railway equipment – Train communication network (TCN) – Part 2-3: TCN communication profile. IEC, 2015.
 - [17] IEC 61375-2-5 Electronic railway equipment – Train communication network (TCN) – Part 2-5: Ethernet train backbone. IEC, 2014.
 - [18] IEC 61375-3-4 Electronic railway equipment – Train communication network (TCN) – Part 3-4: Ethernet Consist Network (ECN). IEC, 2014.
 - [19] IEC 62439-2 Industrial communication networks – High availability automation networks – Part 2: Media Redundancy Protocol (MRP). IEC, 2016.
 - [20] IEEE 802.1AB Station and Media Access Control Connectivity Discovery. IEEE Standard for Local and metropolitan area networks, 2005.
 - [21] IEEE 802.1AX Link Aggregation. IEEE Standard for Local and metropolitan area networks, 2008.
 - [22] IEEE 802.1Q: Virtual Bridged Local Area Networks. IEEE Standard for Local and metropolitan area networks, 2005.
 - [23] IEEE 802.1X: Port-Based Network Access Control. IEEE Standard for Local and metropolitan area networks, 2004.
 - [24] IEEE 802.3af. Amendment: Data Terminal Equipment (DTE) Power via Media Dependent Interface (MDI). IEEE Standard for Local and metropolitan area networks, Part 3: Carrier Sense Multiple Access with Collision Detection (CSMA/CD) Access Method and Physical Layer Specifications, 2003.
 - [25] IEEE 802.3at. Amendment: Data Terminal Equipment (DTE) Power via Media Dependent Interface (MDI) Enhancements. IEEE Standard for Local and metropolitan area networks, Part 3: Carrier Sense Multiple Access with Collision Detection (CSMA/CD) Access Method and Physical Layer Specifications, 2009.
 - [26] R. Johnson, J. Kumarasamy, K. Kinnear, and M. Stapp. DHCP Server Identifier Override Suboption. rfc 5107, IETF, February 2008.
 - [27] S. Knight, D. Weaver, D. Whipple, R. Hinden, D. Mitzel, P. Hunt, P. Higginson, M. Shand, and A. Lindem. Virtual Router Redundancy Protocol. rfc 2338, IETF, April 1998.

-
- [28] P. Leach, M. Mealling, and R. Salz. A Universally Unique Identifier (UUID) URN Namespace. rfc 4122, IETF, July 2005.
 - [29] T. Lemon, S. Cheshire, and B. Volz. The Classless Static Route Option for Dynamic Host Configuration Protocol (DHCP) version 4. rfc 3442, IETF, December 2002.
 - [30] B. Lloyd and W. Simpson. PPP Authentication Protocols. rfc 1334, IETF, October 1992.
 - [31] G. Malkin. RIP Version 2. rfc 2453, IETF, November 1998.
 - [32] G. Malkin and A. Harkin. TFTP Option Extension. rfc 2347, IETF, May 1998.
 - [33] L. Mamakos, K. Lidl, J. Evarts, D. Carrel, D. Simone, and R. Wheeler. A Method for Transmitting PPP Over Ethernet (PPPoE). rfc 2516, IETF, February 1999.
 - [34] G. McGregor. The PPP Internet Protocol Control Protocol (IPCP). rfc 1332, IETF, May 1992.
 - [35] S. Nadas and Ed. Virtual Router Redundancy Protocol (VRRP) Version 3 for IPv4 and IPv6. rfc 5798, IETF, March 2010.
 - [36] K. Nichols, S. Blake, F. Baker, and D. Black. Definition of the Differentiated Services Field (DS Field) in the IPv4 and IPv6 Headers. rfc 2474, IETF, December 1998.
 - [37] G. Pall and G. Zorn. Microsoft Point-To-Point Encryption (MPPE) Protocol. rfc 3078, IETF, March 2001.
 - [38] M. Patrick. DHCP Relay Agent Information Option. rfc 3046, IETF, January 2001.
 - [39] J. Postel. Internet Protocol. rfc 0791, IETF, September 1981.
 - [40] K. Ramakrishnan and S. Floyd. A Proposal to add Explicit Congestion Notification (ECN) to IP. rfc 2481, IETF, January 1999.
 - [41] K. Ramakrishnan, S. Floyd, and D. Black. The Addition of Explicit Congestion Notification (ECN) to IP. rfc 3168, IETF, September 2001.
 - [42] D. Rand. The PPP Compression Control Protocol (CCP). rfc 1962, IETF, June 1996.
 - [43] C. Rigney, W. Willats, and P. Calhoun. RADIUS Extensions. rfc 2869, IETF, June 2000.

-
- [44] C. Rigney, S. Willens, A. Rubens, and W. Simpson. Remote Authentication Dial In User Service (RADIUS). rfc 2865, IETF, June 2000.
 - [45] W. Simpson. PPP Challenge Handshake Authentication Protocol (CHAP). rfc 1994, IETF, August 1996.
 - [46] W. Simpson and Ed. The Point-to-Point Protocol (PPP). rfc 1661, IETF, July 1994.
 - [47] DDW-142 & DDW-242 User Guide. Westermo Doc. number 6642-2250X. Wolverine Series, See <http://www.westermo.com> for updates.
 - [48] DDW-142-485 & DDW-242-485 User Guide. Westermo Doc. number 6642-2251X. Wolverine Series, See <http://www.westermo.com> for updates.
 - [49] DDW-142/242-12VDC-BP User Guide. Westermo Doc. number 6642-2254X. Wolverine Series, See <http://www.westermo.com> for updates.
 - [50] DDW-225 User Guide. Westermo Doc. number 6642-2230X. Wolverine Series, See <http://www.westermo.com> for updates.
 - [51] DDW-226 User Guide. Westermo Doc. number 6642-2240X. Wolverine Series, See <http://www.westermo.com> for updates.
 - [52] Falcon FDV-206-1D1S User Guide. Westermo Doc. number 6660-220X. See <http://www.westermo.com> for updates.
 - [53] Lynx L106/206-F2G User Guide. Westermo Doc. number 6643-225X. See <http://www.westermo.com> for updates.
 - [54] Lynx DSS L108/208-F2G-S2 User Guide. Westermo Doc. number 6643-222X. See <http://www.westermo.com> for updates.
 - [55] Lynx DSS L105/205-S1 User Guide. Westermo Doc. number 6643-223X. See <http://www.westermo.com> for updates.
 - [56] Lynx DSS L106/206-S2 User Guide. Westermo Doc. number 6643-224X. See <http://www.westermo.com> for updates.
 - [57] Lynx L110/210 User Guide. Westermo Doc. number 6643-221X. See <http://www.westermo.com> for updates.
 - [58] RedFox Industrial User Guide. Westermo Doc. number 6641-2231X. RedFox Series, See <http://www.westermo.com> for updates.
 - [59] RedFox Industrial Rack User Guide. Westermo Doc. number 6641-2281X. RedFox Industrial Rack Series, See <http://www.westermo.com> for updates.

- [60] RedFox Rail User Guide. Westermo Doc. number 6641-222X. See <http://www.westermo.com> for updates.
- [61] Viper-12 User Guide. Westermo Doc. number 6641-224X. See <http://www.westermo.com> for updates.
- [62] Viper-12 PoE User Guide. Westermo Doc. number 6641-225X. See <http://www.westermo.com> for updates.
- [63] Viper-12A User Guide. Westermo Doc. number 6641-2251X. See <http://www.westermo.com> for updates.
- [64] Viper-12A PoE User Guide. Westermo Doc. number 6641-2250X. See <http://www.westermo.com> for updates.
- [65] Viper-20A User Guide. Westermo Doc. number 6641-2253X. See <http://www.westermo.com> for updates.
- [66] Viper-20A PoE User Guide. Westermo Doc. number 6641-2252X. See <http://www.westermo.com> for updates.
- [67] Westermo Handbook 5.0 - Industrial Data Communication: Theoretical and General Applications. Available at <http://www.westermo.com> (Accessed February 2014), 2004.
- [68] WeConfig User Guide. Westermo Doc. number 4100-2200X. See <http://www.westermo.com> for updates.
- [69] G. Zorn. Microsoft PPP CHAP Extensions, Version 2. rfc 2759, IETF, January 2000.
- [70] G. Zorn and S. Cobb. Microsoft PPP CHAP Extensions. rfc 2433, IETF, October 1998.

Index

- 1-to-1 NAT, *see* NAT, 1-to-1 NAT
- 802.1X, *see* VLAN, Port-based network access control
- 802.1p, *see* Layer-2 priority
- absolute sampling, *see* alarm, sample type
- Adaptive VLAN Trunking, *see* VLAN, Dynamic VLAN
- address conflict, *see* alarm, trigger, Address Conflict
- Admin Exec context, [53](#), [56](#)
- admin distance, [546](#)
 - for interface, [546](#), [582](#)
- admin distance, [545](#), [547](#), [550–553](#), [594](#), [759–762](#), [787](#), [793–794](#), [809](#), [814–815](#)
 - connected routes, [759](#)
 - for interface, [545](#), [547](#), [550–553](#), [565](#), [567](#), [570](#), [580](#), [583](#), [589](#)
 - OSPF, [759](#), [787](#), [793–794](#)
 - RIP, [759](#), [809](#), [814–815](#)
 - static routes, *see* static route, floating
- alarm
 - WeOS support, [672](#)
 - action, [673](#), [682](#)
 - CLI commands, [690](#)
 - CLI examples
 - Digital-In Trigger, [693](#)
 - FRNT Trigger, [698](#)
 - LFF Trigger, [702](#)
 - Link Trigger, [691](#)
 - Microlok Trigger, [710](#)
 - MRP Trigger, [701](#)
 - Ping Trigger, [705](#)
 - PoE Trigger, [708](#)
 - Power Trigger, [693](#)
 - RiCo Trigger, [700](#)
 - SNR Trigger, [694](#)
 - Temperature Trigger, [696](#)
 - Timer Trigger, [704](#)
 - condition, [678–680](#)
 - link, *see* alarm, trigger
 - sample interval, [680](#)
 - sample type, [680](#)
 - severity level, [681](#)
 - sources, [672](#), [674–675](#), [721](#)
 - summary alarm, [69](#), [718](#)
 - target, [673](#), [682](#), [721](#)
 - threshold, [678–680](#)
 - trigger, [673](#), [675–682](#)
 - Address Conflict, [675](#), [676](#), [678](#), [707](#)
 - Digital-In, [66](#), [674–676](#), [693](#)
 - Dual-Homing, *see* alarm, trigger, RiCo
 - FRNT, [67](#), [674](#), [676](#), [677](#), [698](#)
 - Hardware Failure, [674](#), [676](#)
 - LFF, [68](#), [675](#), [676](#), [678](#), [702](#)
 - Link, [66](#), [261](#), [674](#), [675](#), [677](#), [691](#), [711](#)
 - Microlok, [675](#), [676](#), [710](#)
 - MRP, [70](#), [674](#), [676](#), [677](#), [701](#)
 - Ping, [69](#), [675](#), [676](#), [678](#), [705](#)

- PoE, [675](#), [676](#), [678](#), [708](#)
- Power, [66](#), [675](#), [676](#), [693](#)
- RiCo, [67](#), [674](#), [676](#), [677](#), [700](#), [711](#)
- SNR, [675–677](#), [694](#)
- Temperature, [67](#), [674](#), [675](#), [677](#), [696](#)
- Timer, [676](#), [677](#), [704](#)
- Web settings, [684–689](#)
- AT command interpreter, *see* Serial Over IP, AT command interpreter
- auto-backup and restore, *see* USB, auto-backup and restore
- AVT, *see* VLAN, Dynamic VLAN
- blackhole, [762](#)
 - interface, [762](#)
 - route, [762](#)
- blackhole interface, *see* network interface, blackhole interface
- bypass relay, [15](#), [1158](#)
- cable factory reset, *see* factory reset, using cables
- certificates
 - auto-backup and restore, *see* USB, auto-backup and restore
 - deployment via USB, *see* USB, configuration deployment
 - manage, [119](#)
 - valid time, [977](#)
 - Web server, [119](#), [172](#), [180](#), [197](#)
 - Web settings, [125–127](#)
- CLI
 - access to, [49](#)
 - command conventions, [57](#)
 - enter and leave context, [56](#)
 - hierarchy, [47](#), [56](#)
 - introduction, [47](#)
 - navigating, [56](#)
- command line interface, *see* CLI
- community, *see* SNMP, community
- configuration files
 - account password, [109](#)
 - auto-backup and restore, *see* USB, auto-backup and restore
 - deployment via USB, *see* USB, configuration deployment
 - factory default, [107](#), [109](#)
 - hash, [108](#)
 - running configuration, [57](#), [107](#), [109](#)
 - startup configuration, [57](#), [107](#), [109](#)
 - VFS path, [110](#)
- configuration deployment, *see* USB, configuration deployment
- conflict
 - address, *see* alarm, trigger, Address Conflict
- Connectivity Alarm, *see* Ping alarm
- console
 - access, *see* CLI, access to
 - cable, [49](#)
- CoS, *see* Layer-2 priority
- CPU channel, [142](#), [146](#), [186](#), [372](#), [405](#), [549](#)
- date/time
 - certificates, valid time, [977](#)
 - manual setting of, [169](#)
 - manual setting of (CLI), [185–186](#), [188](#)
 - manual setting of (Web), [175](#)
 - NTP to set, [175](#), [541](#), [542](#), [560](#), [575](#), [977](#)
 - NTP to set (CLI), [602–604](#), [606](#)
 - NTP to set (Web), [175](#), [575–576](#)
- DDM, *see* SFP, DDM
- DDNS, *see* DNS Client, Dynamic DNS
- default gateway, [560](#)
- default route, *see* default gateway
- default VLAN, [371](#)

- delta sampling, *see* alarm, sample type
- DHCP Client
 - client-identifier, [556](#), [617](#)
 - get default route via DHCP, [552](#), [583](#), [593](#), [594](#)
 - get DNS settings via DHCP, [561](#), [595](#)
 - get IP address via DHCP, [549](#), [550](#), [552](#), [556](#), [561](#), [566](#), [571](#), [580](#)
 - get NTP settings via DHCP, [175](#), [560](#), [575](#), [603](#)
 - list clients associated with Server, *see* DHCP Server, list associated clients
 - vendor class identifier, [557](#)
- DHCP Relay Agent, [650–671](#)
- DHCP Server, [596](#), [608–648](#)
 - client-identifier, [617](#)
 - list associated clients, [647](#)
 - Proxy DNS Server, *see* DNS Server, DNS Proxy Server
- diagnostic cable, *see* console, cable
- Diffserv code point, *see* DSCP
- digital I/O, [720–721](#)
 - digital-in, [721](#)
 - pin-out mapping, [720](#)
 - status relay, [682](#), [685](#), [704](#), [706](#), [717](#), [721](#)
 - voltage levels, [720](#), [721](#)
- digital-in, *see* digital I/O, digital-in
- digital-in alarm, *see* alarm, triggers
- digital-out, *see* digital I/O, status relay
- DNS Client
 - DNS Server(s), [551](#), [560](#), [561](#)
 - domain search path, [551](#), [560](#)
 - Dynamic DNS, [560](#), [561](#), [599–601](#)
- DNS Server
 - conditional forwarding, [563](#)
 - DHCP Host Entry, [563](#)
 - DNS Forwarder, [563](#)
 - DNS Proxy Server, [563](#)
 - rejecting AAAA, [564](#)
 - Static Host Entry, [563](#)
- DOM, *see* SFP, DDM
- Domain Name System
 - Client, *see* DNS Client
 - DDNS, *see* DNS Client, Dynamic DNS Server, *see* DNS Server
- DSCP
 - layer-2 support, *see* Layer-2 priority
 - modification of, [867–869](#)
 - prioritising when routing, [869](#)
- DSL alarm, *see* SNR alarm
- Dynamic DNS, *see* DNS Client, Dynamic DNS
- dynamic peer, *see* Serial Over IP, dynamic peer
- Dynamic VLAN, *see* VLAN, Dynamic VLAN
- enterprise MIB, *see* SNMP, private MIB
- error indication, *see* alarm, WeOS support
- factory reset, [87](#), [102](#), [111](#), [204](#)
 - password reset, [102–104](#), [204](#)
 - using cables, [99](#), [104–106](#), [143](#)
 - via CLI, [156](#)
 - via console port, [103–104](#)
 - via Web, [124](#)
- Fallback default VID, [267–268](#)
- falling threshold, *see* alarm, threshold
- fault contact, *see* digital I/O
- firewall
 - logging, [878–882](#)
 - management, [852–925](#)
- firmware

- backup, [88](#)
- bootloader, [89](#)
- downgrading, [89](#)
- primary, [88](#)
- system, [88](#)
- floating static route, *see* static route, floating
- FRNT, [410–433](#)
 - coexistence with RSTP and MRP, [418](#)
- FRNT alarm, *see* alarm, triggers
- general network settings
 - routing, [560](#)
- general network settings, [560](#)
 - IGMP snooping, *see* IGMP snooping
- general network settings
 - domain search path, [551](#)
 - name server, [551](#)
 - NTP server, [551](#), [560](#)
 - static vs dynamic, [552](#)
- Global Configuration context, [53](#), [56](#)
- global network settings, *see* general network settings
- hardware
 - differences between switches running WeOS, [15](#)
- hardware failure alarm, *see* alarm, triggers
- ICMP
 - CLI commands, [601–602](#)
- IEEE 802.1X, *see* VLAN, Port-based network access control
- IGMP snooping
 - proxy querier, [519](#)
 - querier mode, [519](#)
 - query interval, [520](#)
- IGMP snooping, [372](#), [517](#), [560](#)
 - per VLAN, [372](#)
 - querier mode, [560](#)
 - query interval, [560](#)
 - trunk port, *see* IGMP snooping, multicast router port
- interface
 - blackhole, *see* network interface, blackhole interface
- interface admin distance, *see* admin distance, for interface
- IP Masquerading, *see* NAT, NAPT
- IP address
 - link-local, [17](#), [102](#)
- IP address, [549](#)
 - conflict, *see* alarm, trigger, Address Conflict
 - dynamic, [550](#)
 - factory default, [545](#)
 - link-local, [550](#), [552](#), [589](#)
 - new interface, [547](#)
 - via DHCP, *see* DHCP Client, get IP address via DHCP
- IP forwarding, *see* IP routing
- IP routing, [560](#)
 - default gateway, *see* default gateway
 - default route, *see* default gateway
 - static, [560](#)
 - unicast routing, [560](#)
- latest calling, *see* Serial Over IP, dynamic peer
- Layer-2 priority, [259–261](#), [372](#)
 - Custom mapping, [181](#), [200–202](#)
 - VLAN priority, [372](#)
- LFF alarm, *see* alarm, trigger
- licenses
 - manage, [120](#)
 - Web management, [129–130](#)
- Link Aggregation

- Link Alarm, [500–501](#)
 - SNMP support for, [73](#)
 - VLANs, [500](#)
- link alarm, *see* alarm, trigger
- LLDP
 - WeOS support for, [170–171](#)
 - CLI commands, [188–193](#)
 - SNMP support for, [73](#)
 - Web support, [177–179](#)
- log files
 - firewall, *see* firewall logging
 - VFS path, [110](#)
- MAC address
 - conflict, *see* alarm, trigger, Address Conflict
- MAC forwarding database, [375–376](#)
 - CLI commands, [399–400](#), [408–409](#)
- management interface, [545–547](#), [553](#)
 - Web configuration, [565](#)
- management VLAN, *see* management interface
- Media Redundancy Protocol, *see* MRP
- MIB, *see* SNMP, MIB
- Microlok gateway
 - alarm, *see* alarm, triggers
- MicroLok gateway, [1138](#)
- Modbus gateway, [1123](#)
- modem replacement, *see* Serial Over IP, AT command interpreter
- MRP, [120](#), [186](#), [480–494](#)
 - coexistence with FRNT and RSTP, [418](#), [482](#)
- MRP alarm, *see* alarm, triggers
- multicast router port, *see* IGMP snooping, multicast router port
- Multicast Routing, [818–830](#), [838](#), [876](#)
 - NAT and, [876](#)
 - VRRP control of, [838](#)
- NAPT, *see* NAT, NAPT
- NAT, [870–876](#)
 - 1-to-1 NAT, [871–876](#)
 - Forward 1-to-1 NAT, [871–872](#)
 - Multicast Routing and, [876](#)
 - NAPT, [870–871](#)
 - Proxy ARP and 1-to-1 NAT, [874–875](#)
 - Proxy ARP, VRRP and 1-to-1 NAT, [875–876](#)
 - Reverse 1-to-1 NAT, [872–873](#)
- Network Address Port Translation, *see* NAT, NAPT
- Network Address Translation, *see* NAT
- network interface
 - primary, [550](#)
- network interface
 - admin distance, *see* admin distance, for interface
 - blackhole interface, [543](#)
 - factory default settings, [545](#)
 - management interface, *see* management interface
 - naming of, [548](#)
 - new interface settings, [546](#)
 - PPP interface, [542](#), [545](#), [554](#)
 - VLAN, [548](#)
- NTP, *see* date/time, NTP to set
- OpenVPN, *see* SSL VPN
- Packet modification, [866–869](#)
- PAF, *see* SHDSL, PAF
- password
 - admin account, [205](#)
 - allowed characters, [206](#)
 - allowed characters, [205](#), [617](#)
 - default settings, [205](#)
 - length, [205](#), [206](#)
 - reset, *see* factory reset, password reset
- PAT, *see* NAT, NAPT

- PCP, *see* Layer-2 priority
- Ping alarm, *see* alarm, triggers
- PME Aggregation Function, *see* SHDSL, PAF
- PoE alarm, *see* alarm, triggers, *see* PoE alarm
- Point to Point Protocol
 - PPP interface, *see* network interface, PPP interface
 - PPP over Ethernet (PPPoE), [543](#)
- port
 - alarm, *see* alarm, trigger
 - identifier (portID), [257](#)
 - naming of, [255–257](#)
- Port Address Translation, *see* NAT, NAPT
- port monitoring, [725–729](#)
 - CLI commands, [728–729](#)
 - Web configuration, [727](#)
- Port based network access control, *see* VLAN, Port-based network access control
- power failure alarm, *see* alarm, trigger
- PPP, *see* Point to Point Protocol
- private MIB, *see* SNMP, private MIB
- PROFINET, [382](#), [400](#), [409](#)

- read community, *see* SNMP, community
- rising threshold, *see* alarm, threshold
- routing, *see* IP routing
- RSTP, [465–479](#)
 - coexistence with FRNT and MRP, [418](#)
- running configuration, *see* configuration files, running configuration

- sample interval, *see* alarm, sample interval

- Serial/IP[®], *see* Serial Over IP, virtual serial port
- Serial Over IP, [1090](#)
 - AT command interpreter, [1094](#), [1096](#), [1100](#)
 - dynamic peer, [1099](#), [1106](#)
 - CLI commands, [1117](#)
 - modem replacement, *see* Serial Over IP, AT command interpreter
 - One-to-many, [1092](#)
 - Peer mode, [1091](#), [1092](#), [1095](#)
 - Point-to-point, [1091](#)
 - Serial/IP[®], *see* Serial Over IP, virtual serial port
 - TCP client mode, [1091](#), [1095](#)
 - TCP server mode, [1091](#), [1095](#)
 - Secondary listen port, [1097](#)
 - TCP server multipoint mode, [1092](#), [1096](#), [1105](#), [1112](#), [1117](#)
 - UDP, [1091](#), *see* Serial Over IP, Peer mode
 - virtual serial port, [1093](#), [1096](#)
- serial port redirector, *see* Serial Over IP, virtual serial port
- SFP
 - DDM, [46](#), [268–269](#), [273](#), [274](#)
- SHDSL, [302–321](#)
 - PAF, [15](#), [303](#), [305](#)
- slot
 - identifier (slotID), [257](#)
- SNMP, [63](#)
 - CLI commands, [80–84](#)
 - community, [64](#)
 - Management Information Base, *see* SNMP, MIB
 - MIB, [64](#), [72](#), [73](#)
 - private MIB, [73](#)
 - SNMP manager, [63](#), [74](#)
 - SNMPv3, [70–72](#)

- standard MIBs, [72](#)
- supported versions, [63](#)
- trap, [64–65](#)
- Web settings, [76–77](#)
- SNR alarm, *see* alarm, triggers
- SNTP, *see* date/time, NTP to set
- source IP, [762](#)
 - preferred, [594, 762](#)
- Spanning Tree Protocol, *see* RSTP
- SSL VPN, [1014–1066, 1076](#)
- standard MIBs, *see* SNMP, standard MIBs
- startup configuration, *see* configuration files, startup configuration
- static route
 - floating, [552, 552, 594, 759–762, 765](#)
- status interface
 - Web configuration, [570](#)
- status relay, *see* digital I/O, status relay
- Supplicant, *see* VLAN, Port-based network access control
- syslog
 - severity, *see* alarm, severity level
- temperature alarm, *see* alarm, triggers
- ToS field, *see* DSCP
- trap community, *see* SNMP, community
- TTDP, [1154–1180](#)
- Type of service field, *see* DSCP
- USB
 - WeOS products with, [15](#)
 - auto-backup and restore, [100, 113–117](#)
 - configuration deployment, [100, 117–119](#)
- console cable, *see* console, cable
- copy files to/from, [110, 154–156](#)
- delete file on, [156](#)
- firmware upgrade from, [140–141](#)
- format of memory stick, [110](#)
- list files on, [154](#)
- show file on, [157](#)
- VFS path, [110](#)
- Virtual Router Redundancy Protocol, *see* VRRP
- virtual serial port, *see* Serial Over IP, virtual serial port
- VLAN, [366–409](#)
 - CLI commands, [398–409](#)
 - CPU channel, *see* CPU channel
 - default VLAN, [371](#)
 - default VID, [267–268, 371](#)
 - Dynamic VLAN, [373–375](#)
 - FRNT usage of, [417](#)
 - IGMP snooping, *see* IGMP snooping, per VLAN
 - management VLAN, *see* management interface
 - Port-based network access control, [383–394](#)
 - IEEE 802.1X, [203, 212, 227, 384](#)
 - MAC authentication, [230, 386](#)
 - priority, *see* Layer-2 priority, VLAN priority
 - priority tagged, [371](#)
 - tagged, [367–371, 389, 391, 403](#)
 - TUNNELING q-in-q, [377](#)
 - untagged, [367–371, 389, 391, 403](#)
 - Web settings, [388–397](#)
- VRRP, [831–851](#)
 - Advertisement Interval, [834, 836](#)
 - authentication, [836–837](#)
 - control of Multicast Routing, [838](#)
 - dynamic priority, [682, 835](#)
 - fast failover, [836](#)

Load sharing using, [838](#)
priority, [835](#)
synchronisation groups, [837](#)
Virtual IP Address (VIP), [834](#)
Virtual Router Identifier, *see* VRRP,
VRID
VRID, [834](#)
VRRP Instance, [833](#)
VRRPv2, [834](#), [836–837](#)
VRRPv3, [834](#), [836](#)

Wake-On-LAN, [120](#), [121](#), [135](#), [165](#)
Web server
 certificate, *see* certificates, Web server
WeConnect, [1068](#)
WOL, *see* Wake-On-LAN
write community, *see* SNMP, commu-
 nity